

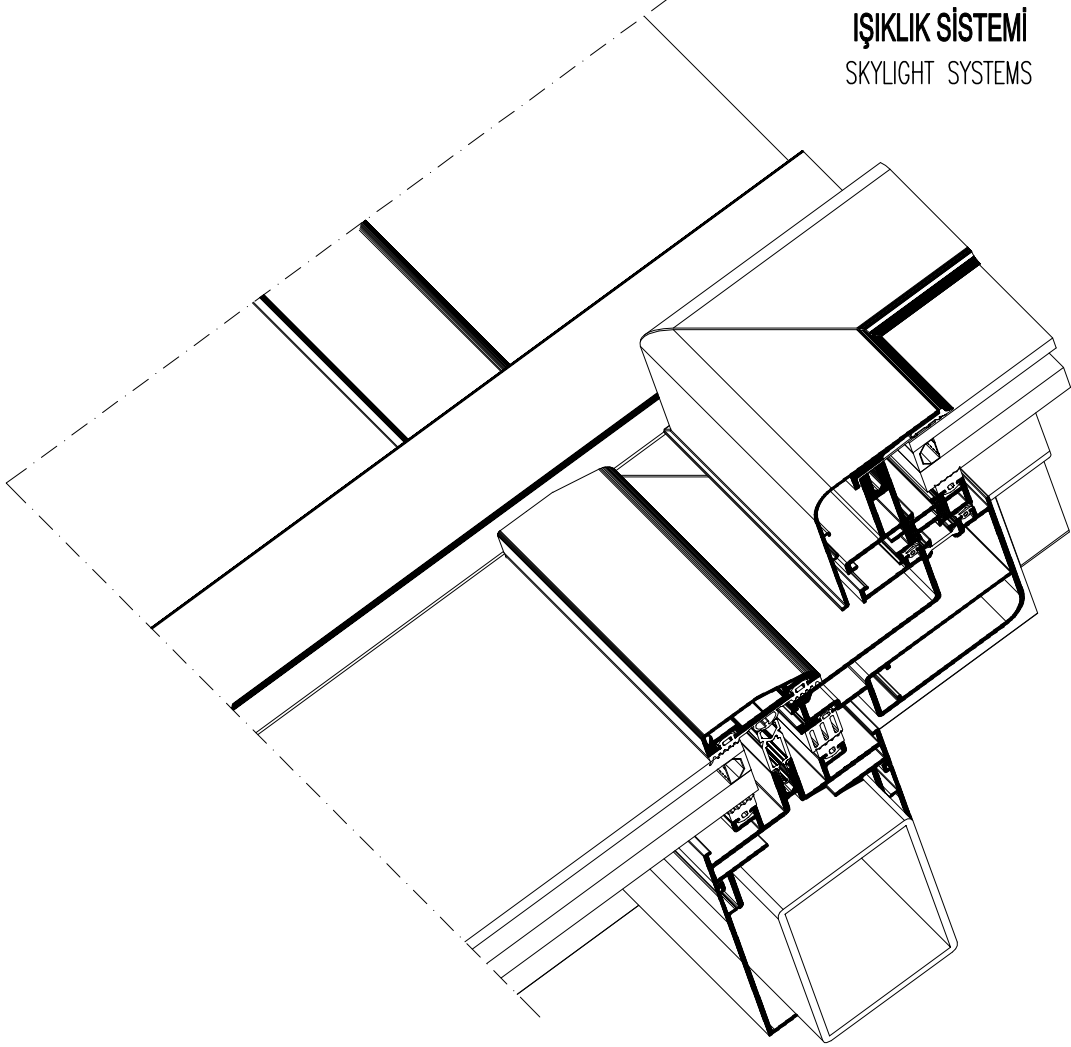







İŞIKLIK SİSTEMİ
SKYLIGHT SYSTEMS

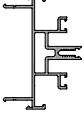

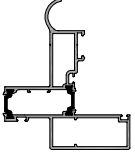
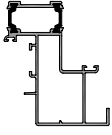
SKY78
İŞIKLIK SİSTEMİ
SKYLIGHT SYSTEMS

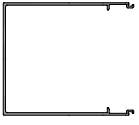
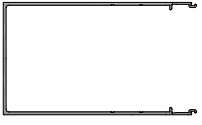
SKY78
İŞIKLIK SİSTEMİ
SKYLIGHT SYSTEMS

ÜRÜN TEKNİK ÖZELLİKLERİ
PRODUCT'S TECHNICAL FEATURES

No. Nr.	PROFİL KESİTİ PROFILE VIEW	PROFİL NO PROFILE NO	PROFİL AÇIKLAMASI PROFILE DESCRIPTION	BAĞLANTI PARÇALARI CORNER CLEATS	gr/m	STATİK STATIC			
						Ix cm ⁴	Iy cm ⁴	Wx cm ³	Wy cm ³
1		SK78-101 (54 - 78) (2 mm)	TAŞIYICI PROFİL MULLION OR TRANSOM PROFILE		1439	7,29	24,23	2,57	6,21
2		SK78-102 (54 - 78) (2 mm)	TAŞIYICI PROFİL MULLION OR TRANSOM PROFILE		1544	7,00	34,00	2,35	8,72
3		SK78-201 (87 - 82,5) (2 mm)	KANAT KASA PR. OUTER FRAME PROFILE	W-611-d (25,3 mm) W-611-k (19,6 mm)	PVC 2312				
					POLYAMID 2299				
4		SK78-202 (73 - 86,3) (1,6 mm)	KANAT PROFİLİ FRAME PROFILE	W-611-l (60,40 mm)	PVC 1760				
					POLYAMID 1747				
5		SK78-203 (83 - 13,2) (1,8 mm)	KAPAK PROFİLİ COVER PROFILE		725				
6		SK78-301 (90,8 - 78) (1,6 mm)	KAPAK PROFİLİ COVER PROFILE		1123				
7		SK78-302 (134,3 - 78) (2 mm)	KAPAK PROFİLİ COVER PROFILE		1835				
8		SK78-303 (50 - 12) (1,3 mm)	KAPAK PROFİLİ COVER PROFILE	SK78-304	233				
9		SK78-304 (46,5 - 9) (2 mm)	BASKI PROFİLİ PRESSURE PROFILE		383				
10		KC0301 (46,9 - 9) (2 mm)	BASKI PROFİLİ PRESSURE PROFILE		496				

Profil değerleri teoriktir. Ağırlık olarak testimde yapılan tartım geçerlidir.
Profil imalatları TS EN 12020-2 ve TS EN 755-9 toleransları,
Moment değerleri EN 14024'e göre hesaplanmıştır.

Profile values are theoretical pre-shipment weight will be valid.
The tolerances of Profile manufacturing are calculated according to EN 12020-2
and TS EN 755-9; moment values are calculated according to EN 14024.

SKY78
İŞIKLIK SİSTEMİ
SKYLIGHT SYSTEMS

ÜRÜN TEKNİK ÖZELLİKLERİ
PRODUCT'S TECHNICAL FEATURES













No. Nr.	PROFİL KESİTİ PROFILE VIEW	PROFİL NO PROFILE NO	PROFİL AÇIKLAMASI PROFILE DESCRIPTION	BAĞLANTI PARÇALARI CORNER CLEATS	gr/m	STATİK STATIC			
						Ix cm ⁴	Iy cm ⁴	Wx cm ³	Wy cm ³
11		KC0307 (95.8 - 29.2)	45° - BASKI PROFİLİ 45°-PRESSURE PROFILE	KC0318	786				
12		KC0310 (192 mmØ) (15 mm)	KAPAK PROFİLİ COVER PROFILE	KC0301	308				
13		KC0318 (123.5 - 37.6) (15 mm)	45° - KAPAK PROFİLİ 45°-COVER PROFILE	KC0307	912				
14		KC0327 (77.6 - 26) (15 mm)	15° - KAPAK PROFİLİ 15°-COVER PROFILE	KC0328	562				
15		KC0328 (66.3 - 17.7) (15 mm)	15° - BASKI PROFİLİ 15°-PRESSURE PROFILE	KC0327	527				
16		KC0329 (99.5 - 33.2) (15 mm)	30° - KAPAK PROFİLİ 30°-COVER PROFILE	KC0330	674				
17		KC0330 (79.3 - 24.7) (15 mm)	30° - BASKI PROFİLİ 30°-PRESSURE PROFILE	KC0329	614				
18		KS-409 (16,6 - 4) (13 mm)	KÜPEŞTE KAPAK PROFİLİ HANDRAIL, BANISTER COVER PROFILE		70				
19		KC0331 (20 - 11) (12 mm)	TEK CAM ADAPTÖRÜ PR. SINGLE GLAZING ADAPTER PROFILE		209				
20		KC0332 (22 - 11) (12 mm)	TEK CAM ADAPTÖRÜ PR. SINGLE GLAZING ADAPTER PROFILE		222				

Profil değerleri teoriktir. Ağırlık olarak testimde yapılan tartım geçerlidir.
Profil imatları TS EN 12020-2 ve TS EN 755-9 toleransı,
Moment değerleri EN 14024'e göre hesaplanmıştır.

Profile values are theoretical pre-shipment weight will be valid.
The tolerances of Profile manufacturing are calculated according to EN 12020-2
and TS EN 755-9; moment values are calculated according to EN 14024.

SKY78
İŞIKLIK SİSTEMİ
SKYLIGHT SYSTEMS

ÜRÜN TEKNİK ÖZELLİKLERİ
PRODUCT'S TECHNICAL FEATURES





No. Nr.	PROFİL KESİTİ PROFILE VIEW	PROFİL NO PROFILE NO	PROFİL AÇIKLAMASI PROFILE DESCRIPTION	BAĞLANTI PARÇALARI CORNER CLEATS	gr/m	STATİK STATIC			
						Ix cm ⁴	Iy cm ⁴	Wx cm ³	Wy cm ³
21		KC0333 (16 - 11) (12 mm)	TEK CAM ADAPTÖRÜ PR. SINGLE GLAZING ADAPTER PROFILE		183				
22		KC0334 (18 - 11) (12 mm)	TEK CAM ADAPTÖRÜ PR. SINGLE GLAZING ADAPTER PROFILE		196				
23		KC0340 (10.7 - 8.3) (12 mm)	15° - ADAPTÖR PROFİLİ 15°-ADAPTER PROFILE		98				
24		KC0341 (10.7 - 10.3) (12 mm)	30° - ADAPTÖR PROFİLİ 30°-ADAPTER PROFILE		105				
25		KC0342 (10.7 - 11.9) (12 mm)	45° - ADAPTÖR PROFİLİ 45°-ADAPTER PROFILE		112				
26		KC0343 (10.7 - 13.6) (12 mm)	60° - ADAPTÖR PROFİLİ 60°-ADAPTER PROFILE		123				
27	  İşaretili profil için satış ekibinden bilgi alınır.	KC0344 (140.7 - 49.7) (15 mm)	60° - KAPAK PROFİLİ 60°-COVER PROFILE	KC0345	994				
28	  İşaretili profil için satış ekibinden bilgi alınır.	KC0345 (106.4 - 40.3) (15 mm)	60° - BASKI PROFİLİ 60°-PRESSURE PROFILE	KC0343	903				
29		KC0350 (6 - 11) (1 mm)	TEK CAM ADAPTÖRÜ PR. SINGLE GLAZING ADAPTER PROFILE		96				
30		KC0347 (24 - 11) (12 mm)	TEK CAM ADAPTÖRÜ PR. SINGLE GLAZING ADAPTER PROFILE		235				

Profil değerleri teoriktir. Ağırlık olarak teslimde yapılan tartım geçerlidir.
Profil imalatları TS EN 12020-2 ve TS EN 755-9 toleransı,
Moment değerleri EN 14024'e göre hesaplanmıştır.

Profile values are theoretical pre-shipment weight will be valid.
The tolerances of Profile manufacturing are calculated according to EN 12020-2
and TS EN 755-9; moment values are calculated according to EN 14024.

SKY78
İŞIKLIK SİSTEMİ
SKYLIGHT SYSTEMS

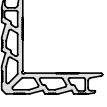
ÜRÜN TEKNİK ÖZELLİKLERİ
PRODUCT'S TECHNICAL FEATURES

No. Nr.	PROFİL KESİTİ PROFILE VIEW	PROFİL NO PROFILE NO	PROFİL AÇIKLAMASI PROFILE DESCRIPTION	BAĞLANTI PARÇALARI CORNER CLEATS	gr/m	STATİK STATIC			
						Ix cm ⁴	Iy cm ⁴	Wx cm ³	Wy cm ³
31		KC0351 (14 - 11) (12 mm)	TEK CAM ADAPTÖRÜ PR. SINGLE GLAZING ADAPTER PROFILE		154				
32	  İşaretili profil için satış ekibinden bilgi alınır.	KC0352 (30 - 11) (12 mm)	TEK CAM ADAPTÖRÜ PR. SINGLE GLAZING ADAPTER PROFILE		274				
33		W-611 (70 - 70)	KÖŞE BİRLEŞTİRME CORNER CLEATS		2520				
34		EC0201 (19.3 - 17) (12 mm)	ÇİFT CAM İÇİ PANEL PR. PANEL PROFILE FOR DOUBLE GLASS		220				
35		EC0301 (22.1 - 10.7) (12 mm)	BAĞLANTI PROFİLİ CONNECTION PROFILE		223				
36									
37									
38									
39									
40									

Profil değerleri teoriktir. Ağırlık olarak testimde yapılan tartım geçerlidir.
Profil imalatları TS EN 12020-2 ve TS EN 755-9 toleransı,
Moment değerleri EN 14024'e göre hesaplanmıştır.

Profile values are theoretical pre-shipment weight will be valid.
The tolerances of Profile manufacturing are calculated according to EN 12020-2
and TS EN 755-9; moment values are calculated according to EN 14024.

SKY78
İŞIKLIK SİSTEMİ
SKYLIGHT SYSTEMS

ÜRÜN TEKNİK ÖZELLİKLERİ
PRODUCT'S TECHNICAL FEATURES

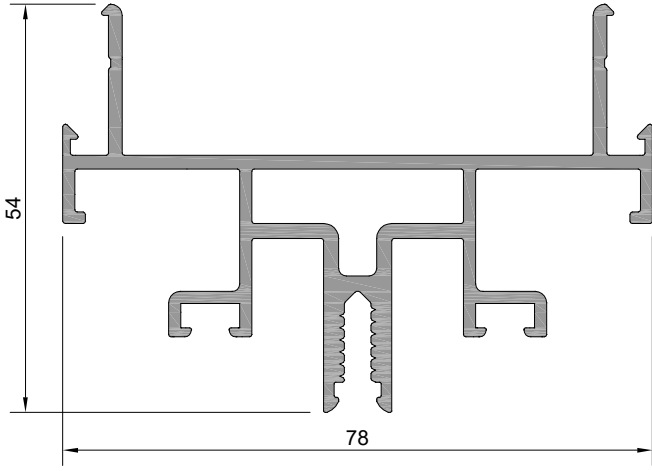

Profil No: SK78-101
Ağırlık : 1439 gr/m
lx : 7,29 cm⁴
ly : 24,23 cm⁴
wx : 2,569 cm³
wy : 6,212 cm³

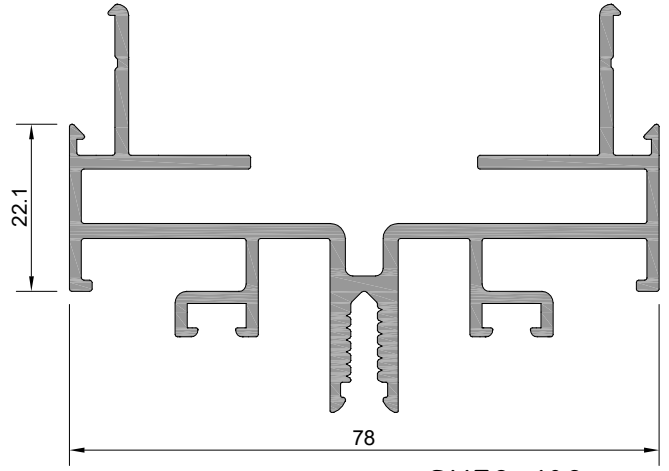

Profil No: SK78-102
Ağırlık : 1544 gr/m
lx : 7,00 cm⁴
ly : 34,00 cm⁴
wx : 2,35 cm³
wy 78 : 8,72 cm³

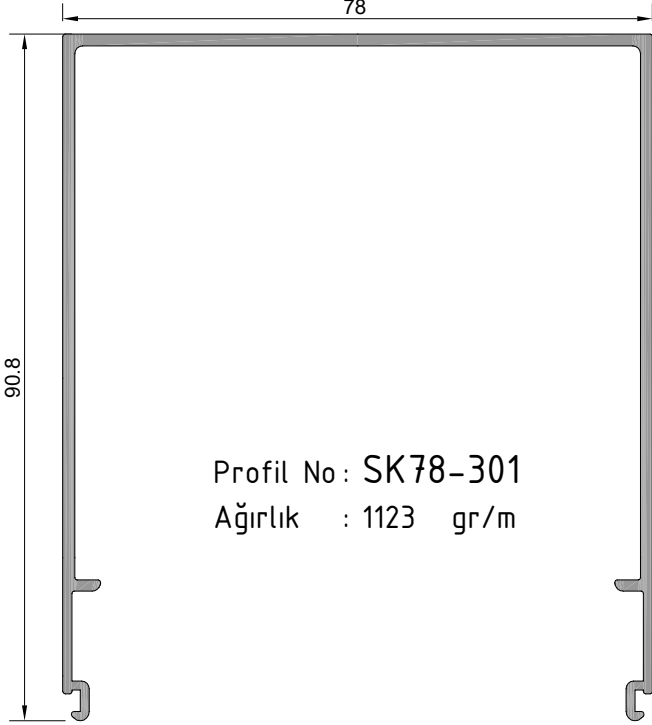

Profil No: SK78-301
Ağırlık : 1123 gr/m

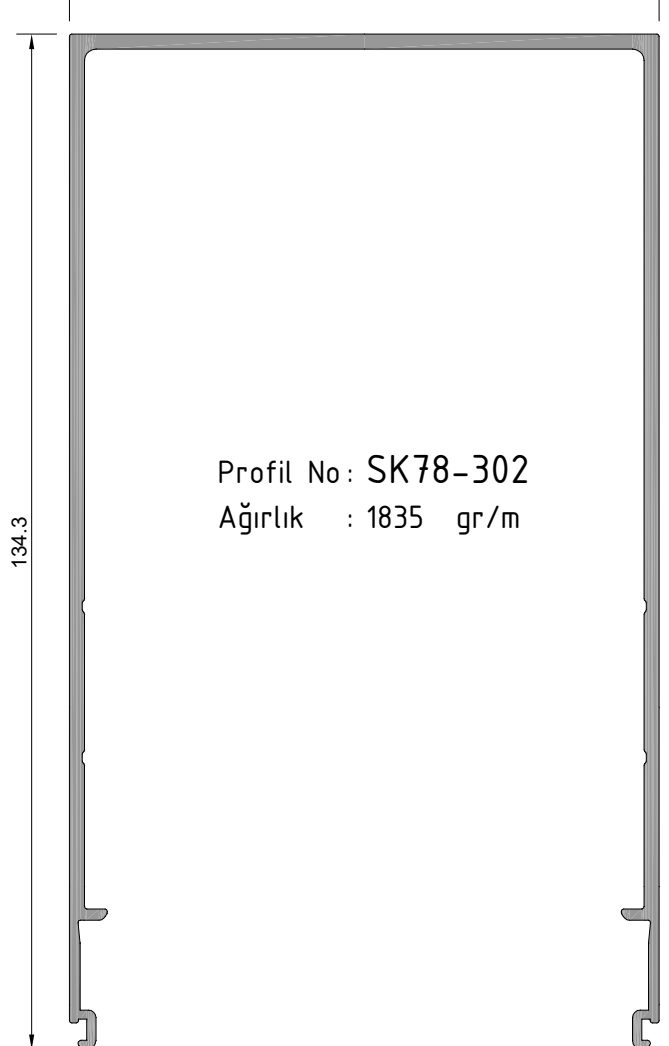

Profil No: SK78-302
Ağırlık : 1835 gr/m

SKY78
İŞIKLIK SİSTEMİ
SKYLIGHT SYSTEMS

ÜRÜN TEKNİK ÖZELLİKLERİ
PRODUCT'S TECHNICAL FEATURES

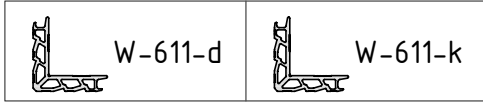
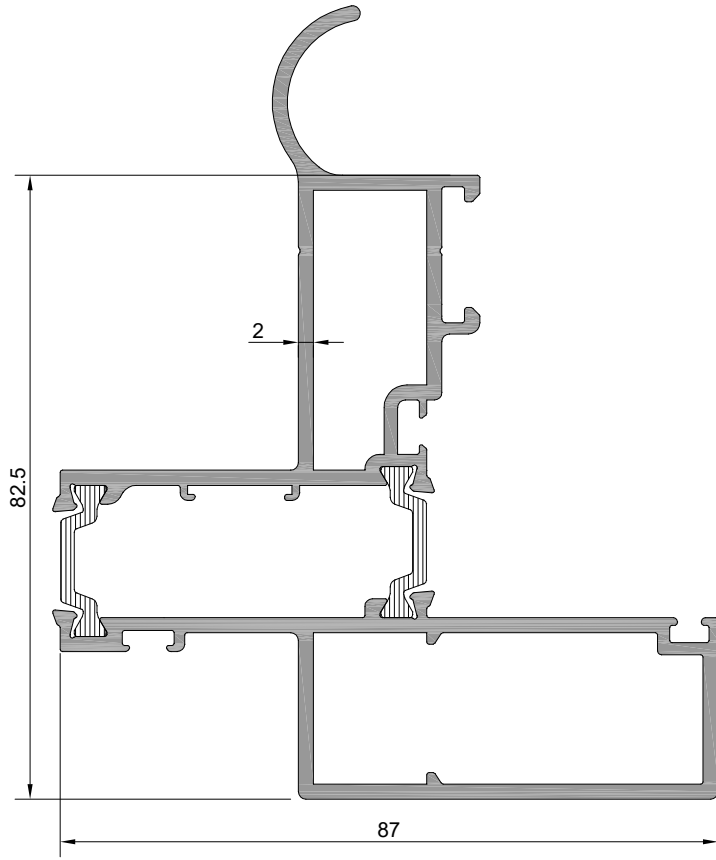

Profil No : SK78-201

Ağırlık PVC	: 2312	gr/m
Ağırlık POLY	: 2299	gr/m

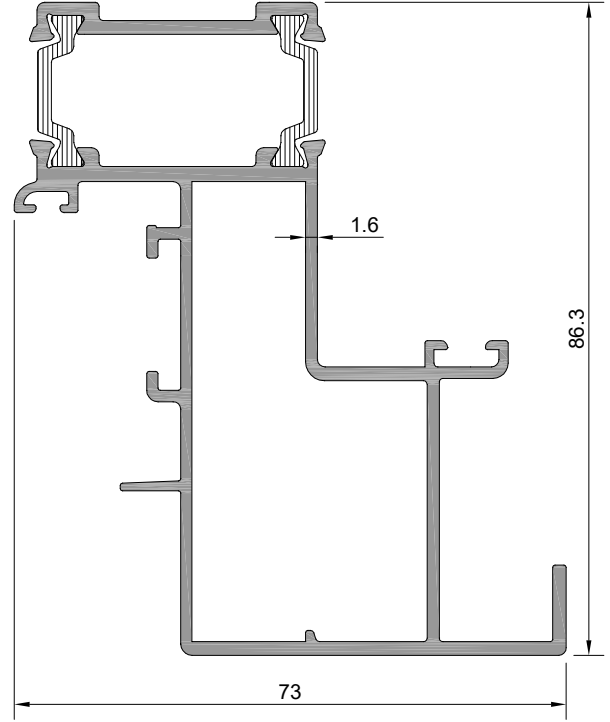

Profil No : SK78-202

Ağırlık PVC	: 1760	gr/m
Ağırlık POLY	: 1747	gr/m

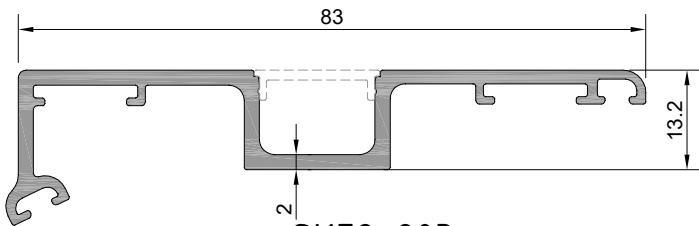

Profil No : SK78-203
Ağırlık : 725 gr/m

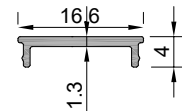

Profil No : KS-409
Ağırlık : 70 gr/m

SKY78
İŞIKLIK SİSTEMİ
SKYLIGHT SYSTEMS

ÜRÜN TEKNİK ÖZELLİKLERİ
PRODUCT'S TECHNICAL FEATURES

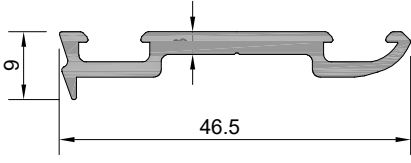

Profil No : SK78-304
Ağırlık : 383 gr/m

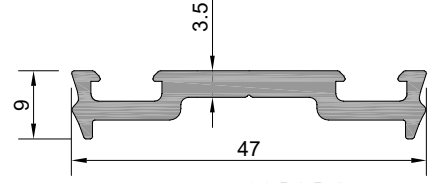

Profil No : KC0301
Ağırlık : 496 gr/m

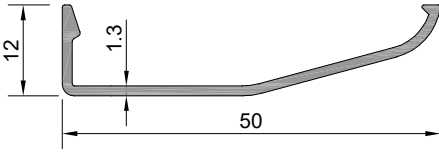

Profil No : SK78-303
Ağırlık : 233 gr/m

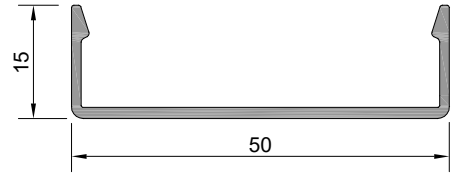

Profil No : KC0310
Ağırlık : 308 gr/m



Profil No : KC0307
Ağırlık : 786 gr/m

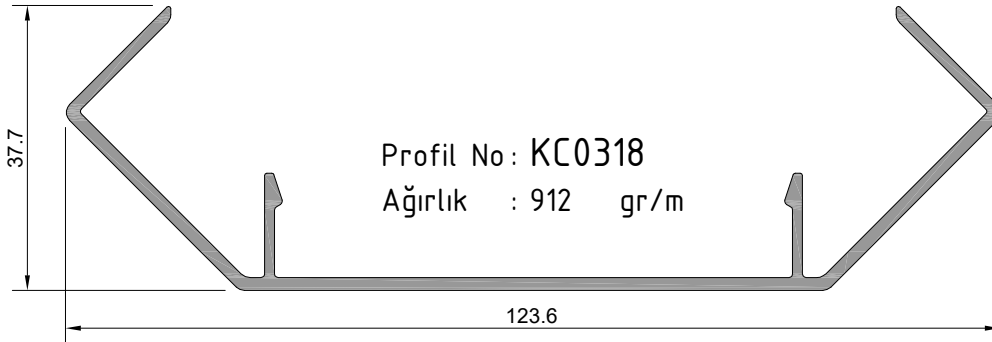

Profil No : KC0318
Ağırlık : 912 gr/m

SKY78
İŞIKLIK SİSTEMİ
SKYLIGHT SYSTEMS

ÜRÜN TEKNİK ÖZELLİKLERİ
PRODUCT'S TECHNICAL FEATURES

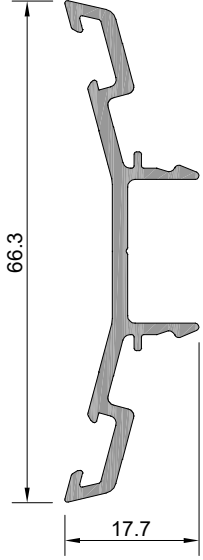

Profil No : KC0328
Ağırlık : 527 gr/m

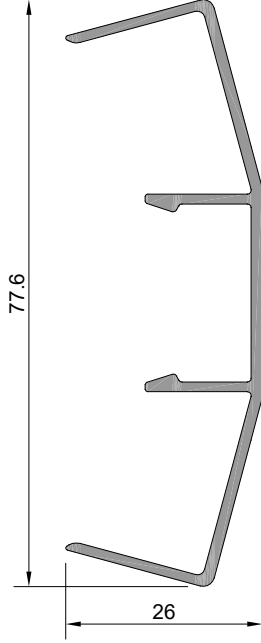

Profil No : KC0327
Ağırlık : 562 gr/m

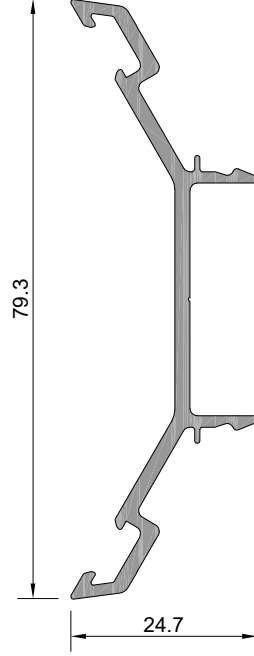

Profil No : KC0330
Ağırlık : 614 gr/m

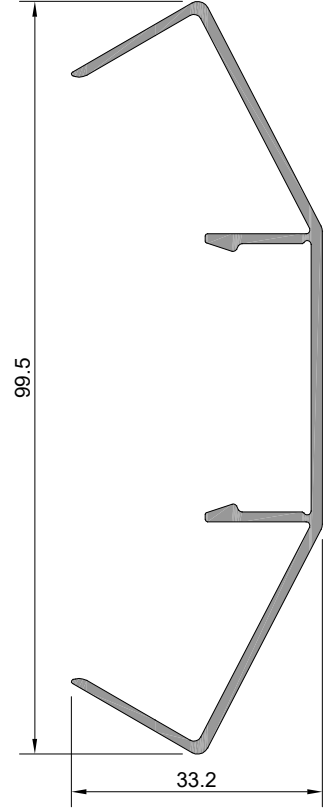

Profil No : KC0329
Ağırlık : 674 gr/m

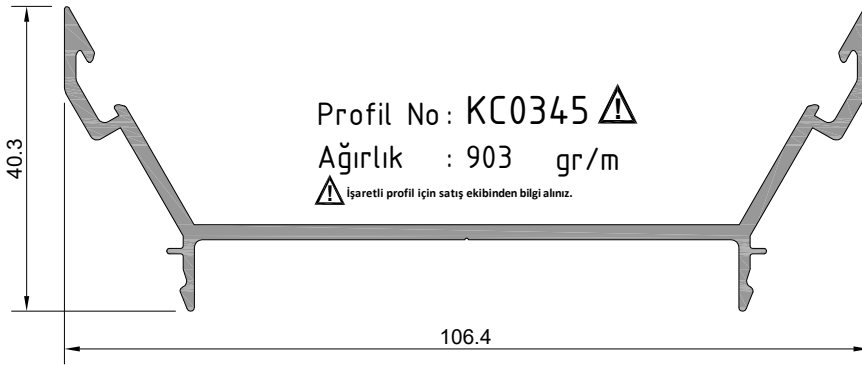

Profil No : KC0345 ⚠

Ağırlık : 903 gr/m

⚠ İşaretti profil için satış ekibinden bilgi alınır.

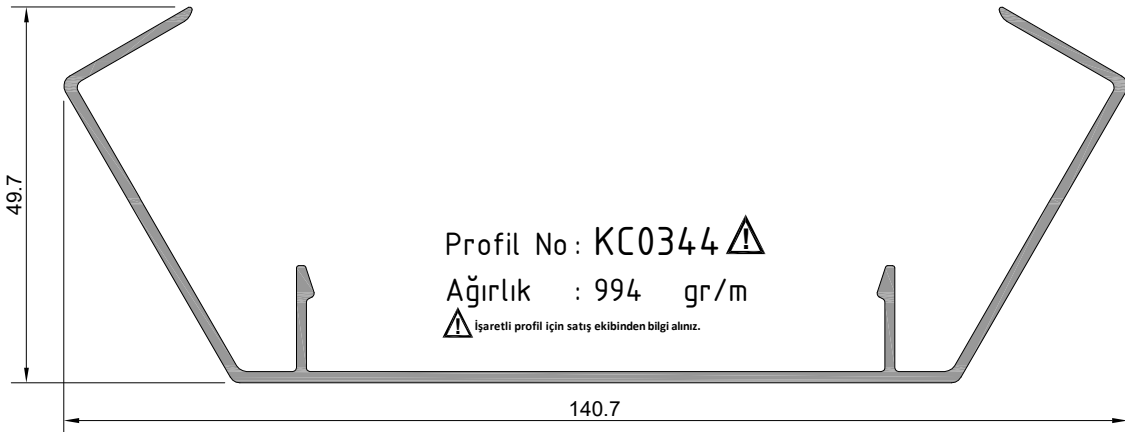

Profil No : KC0344 ⚠

Ağırlık : 994 gr/m

⚠ İşaretti profil için satış ekibinden bilgi alınır.

SKY78
İŞIKLIK SİSTEMİ
SKYLIGHT SYSTEMS

ÜRÜN TEKNİK ÖZELLİKLERİ
PRODUCT'S TECHNICAL FEATURES

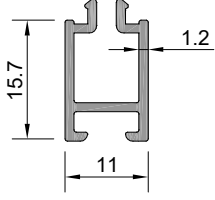

Profil No : KC0333
Ağırlık : 183 gr/m

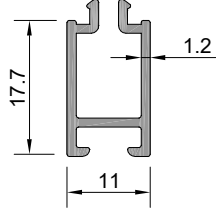

Profil No : KC0334
Ağırlık : 196 gr/m

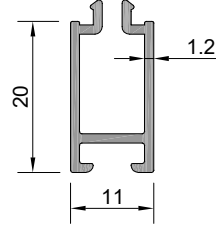

Profil No : KC0331
Ağırlık : 209 gr/m

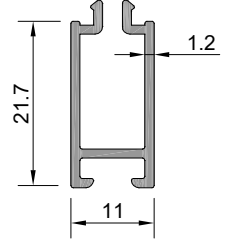

Profil No : KC0332
Ağırlık : 222 gr/m

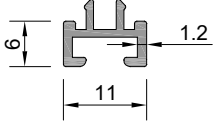

Profil No : KC0350
Ağırlık : 96 gr/m

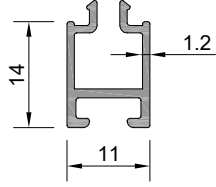

Profil No : KC0351
Ağırlık : 154 gr/m

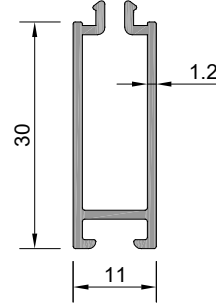

Profil No : KC0352 ⚠
Ağırlık : 274 gr/m
⚠ İşaretti profil için satış ekibinden bilgi alınız.

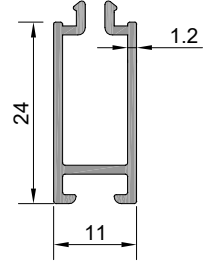

Profil No : KC0347
Ağırlık : 235 gr/m

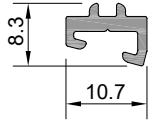

Profil No : KC0340
Ağırlık : 98 gr/m

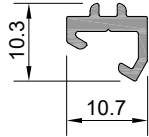

Profil No : KC0341
Ağırlık : 105 gr/m

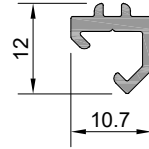

Profil No : KC0342
Ağırlık : 112 gr/m

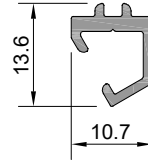

Profil No : KC0343
Ağırlık : 123 gr/m

SKY78
İŞIKLIK SİSTEMİ
SKYLIGHT SYSTEMS

ÜRÜN TEKNİK ÖZELLİKLERİ
PRODUCT'S TECHNICAL FEATURES

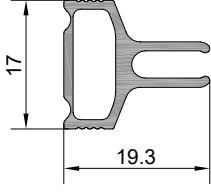

Profil No : EC0201
Ağırlık : 220 gr/m

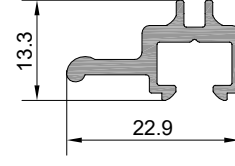

Profil No : EC0301
Ağırlık : 223 gr/m



EC0301-a	50 mm	100 adet/pcs
----------	-------	--------------

Profil No : W-611
Ağırlık : 2520 gr/m

W-611-d	25.3 mm	100 adet/pcs
W-611-k	19.6mm	100 adet/pcs
W-611-l	60.4mm	100 adet/pcs

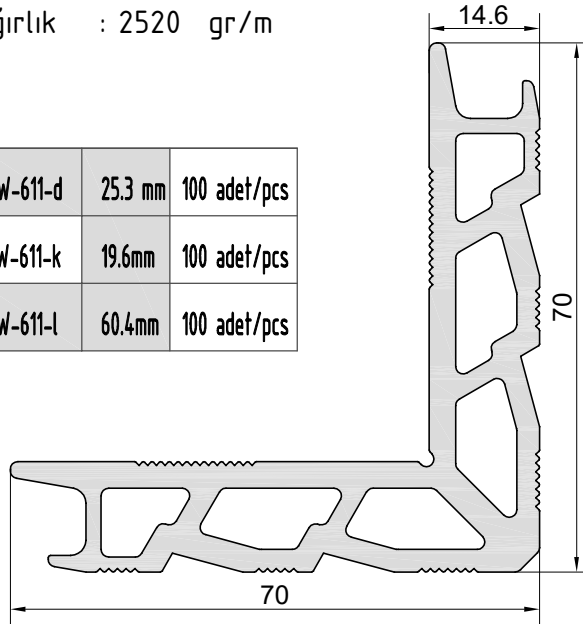

SKY78
İŞILIK SİSTEMİ
 SKYLIGHT SYSTEMS

SABİT - SABİT
 FIXED-FIXED

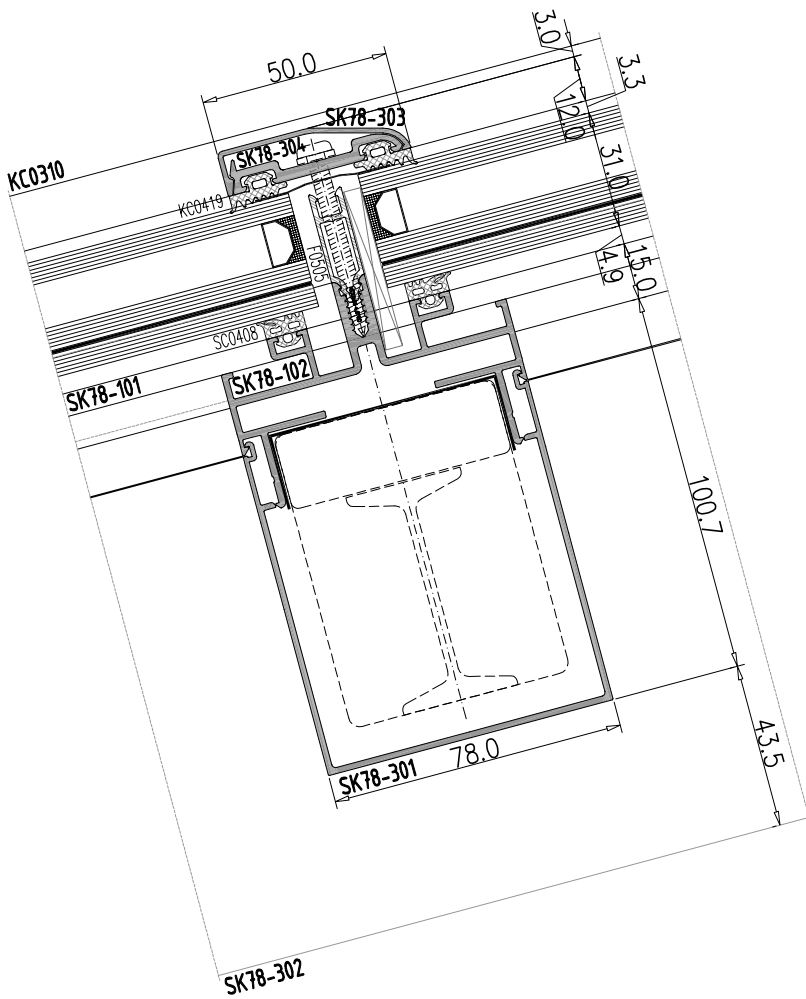
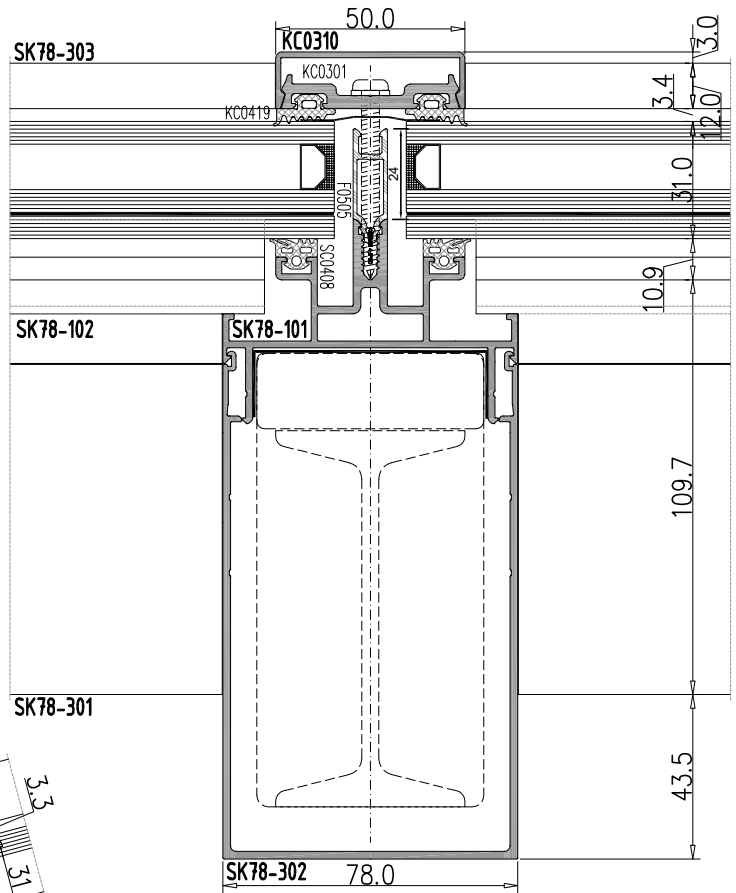
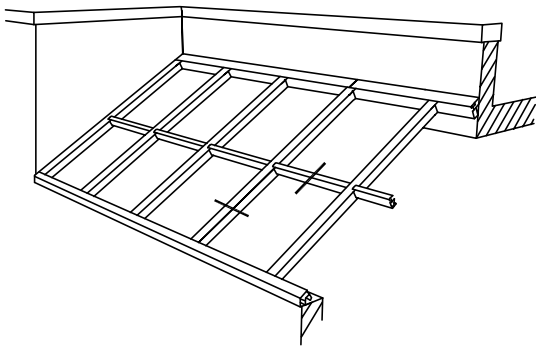

SKY78
İŞILIK SİSTEMİ
SKYLIGHT SYSTEMS

SABIT - KANAT
FIXED-SASH

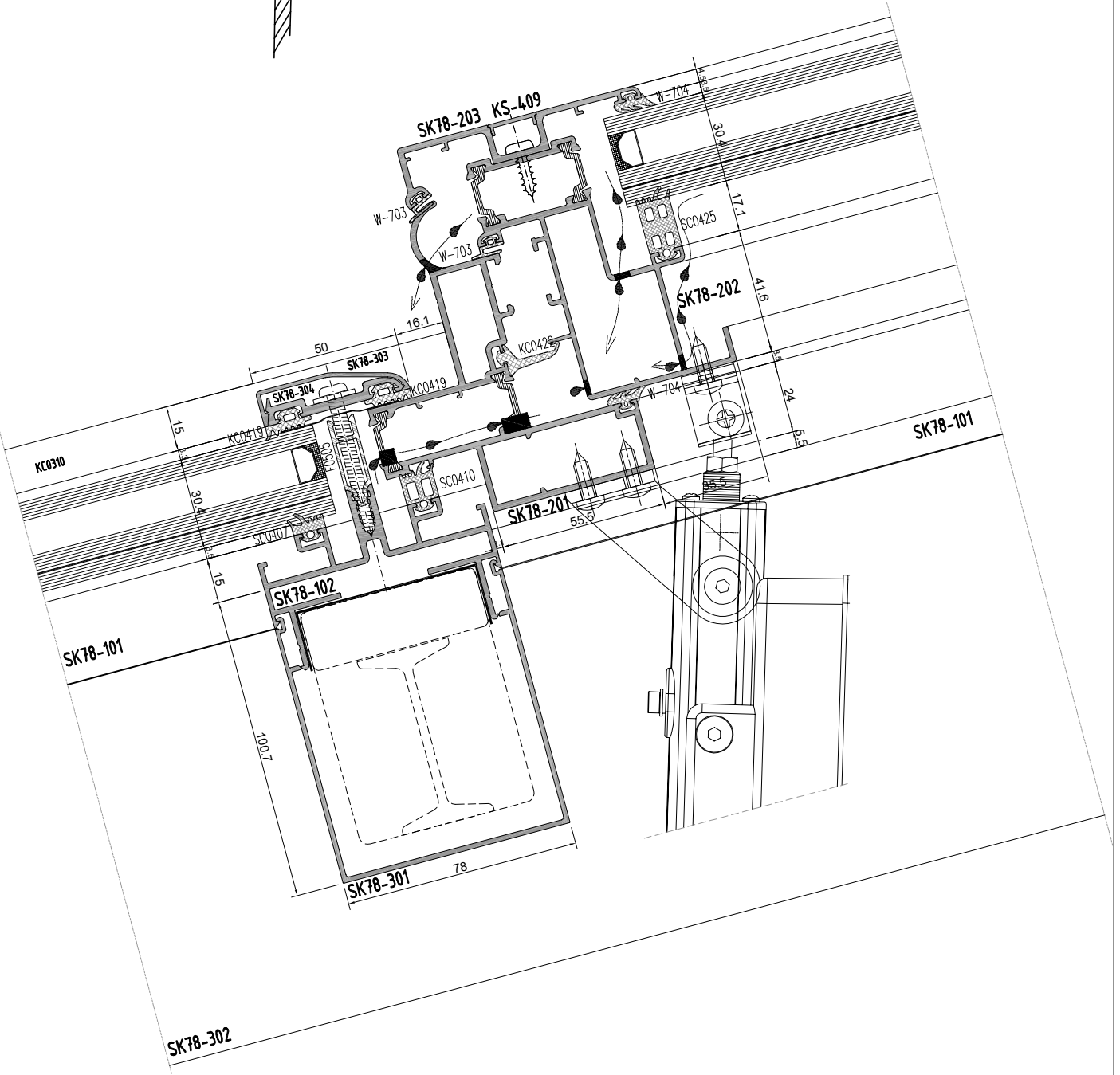
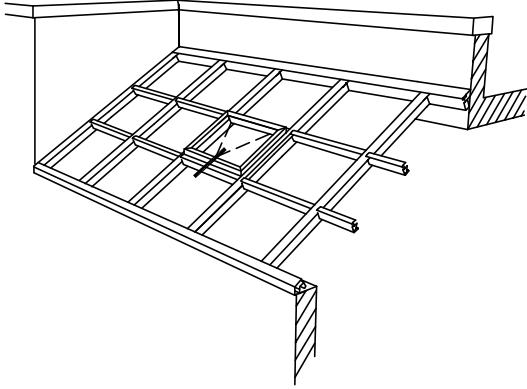

ÖLÇEKSİZ
NOT TO SCALE

SKY78
IŞILIK SİSTEMİ
SKYLIGHT SYSTEMS

SABİT - KANAT
FIXED-SASH

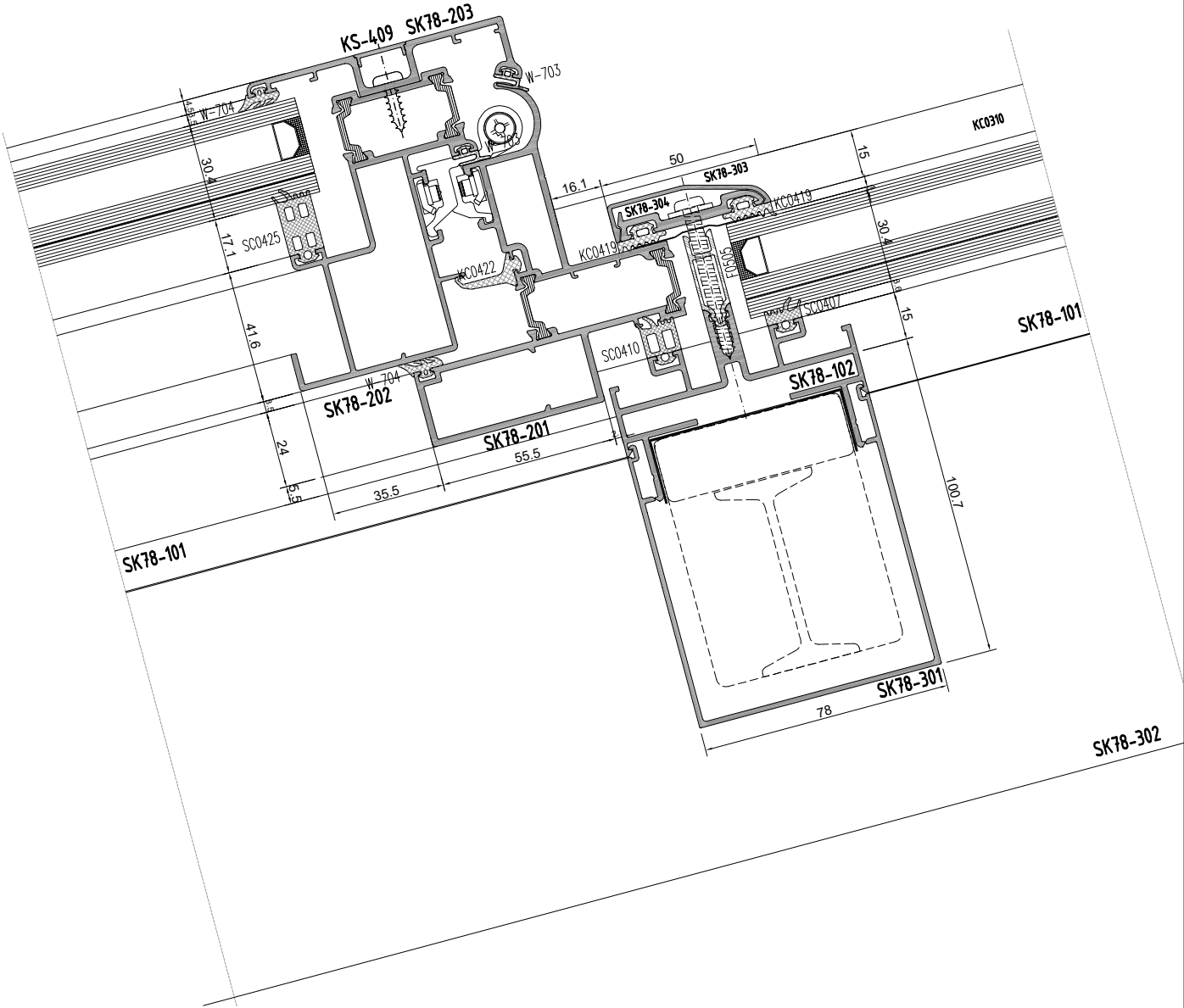
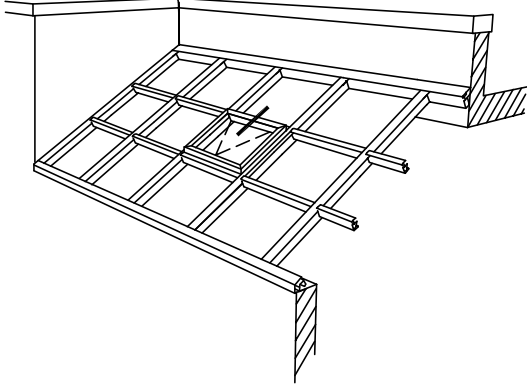

ÖLÇEKSİZ
NOT TO SCALE

SKY78
İŞILIK SİSTEMİ
SKYLIGHT SYSTEMS

SABİT - SABİT
FIXED-FIXED

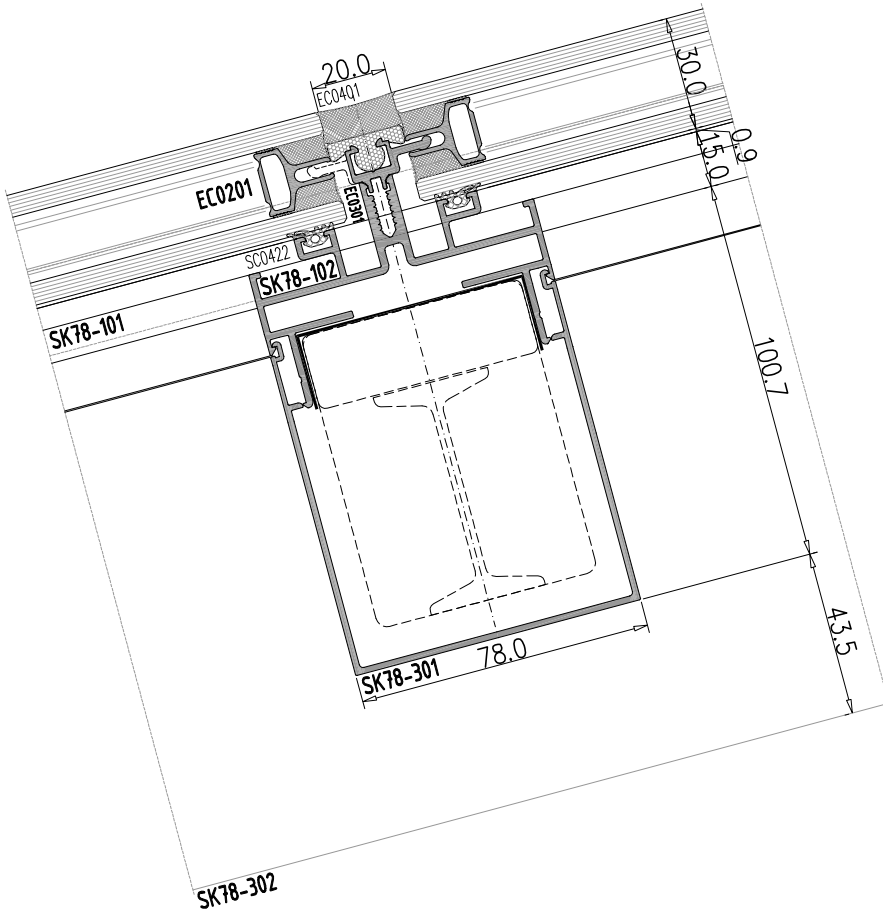
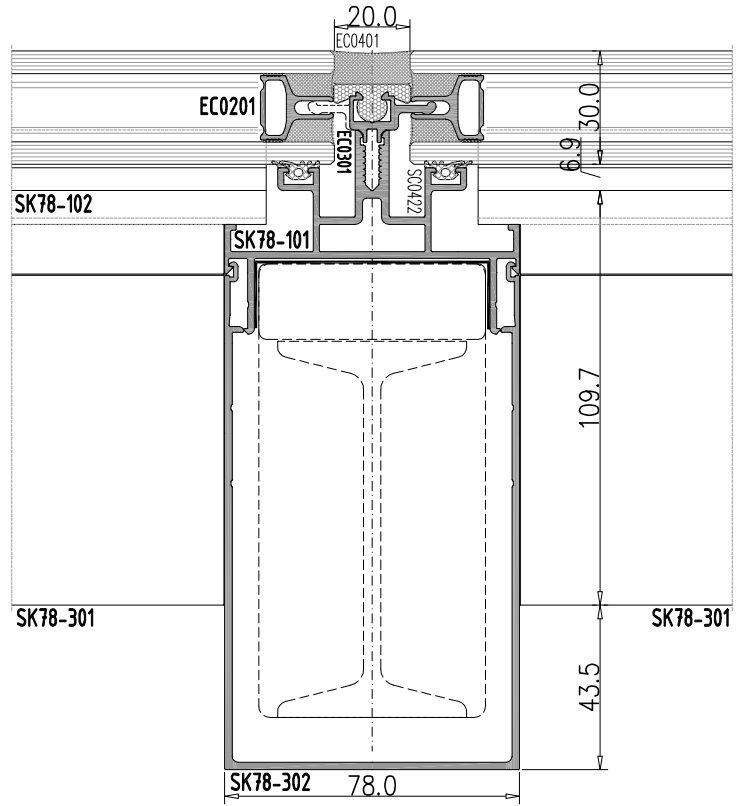
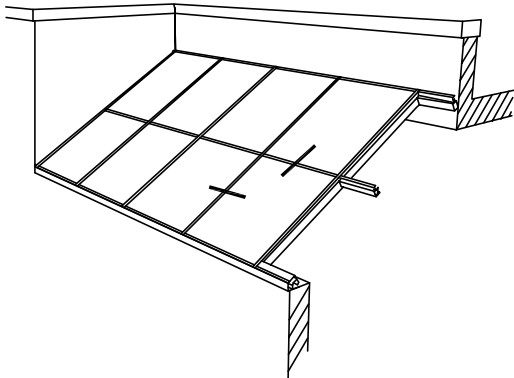

SKY78
İŞILIK SİSTEMİ
SKYLIGHT SYSTEMS

SABİT - SABİT
FIXED-FIXED

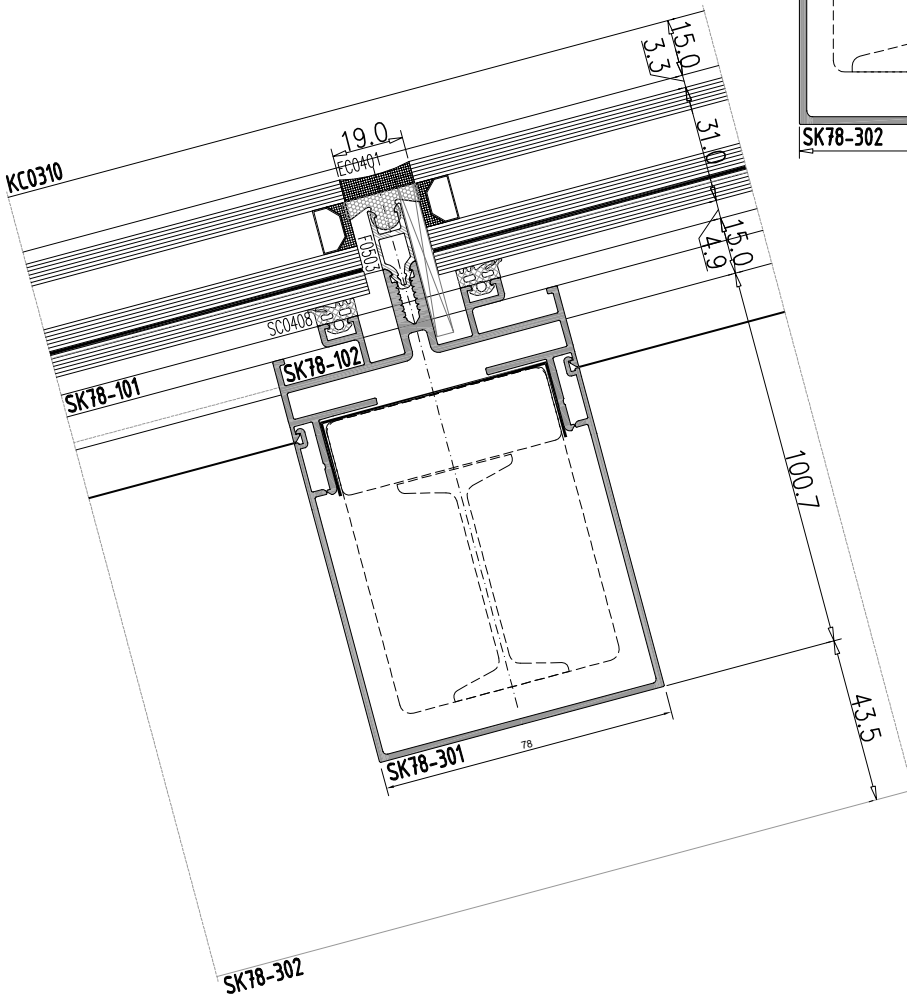
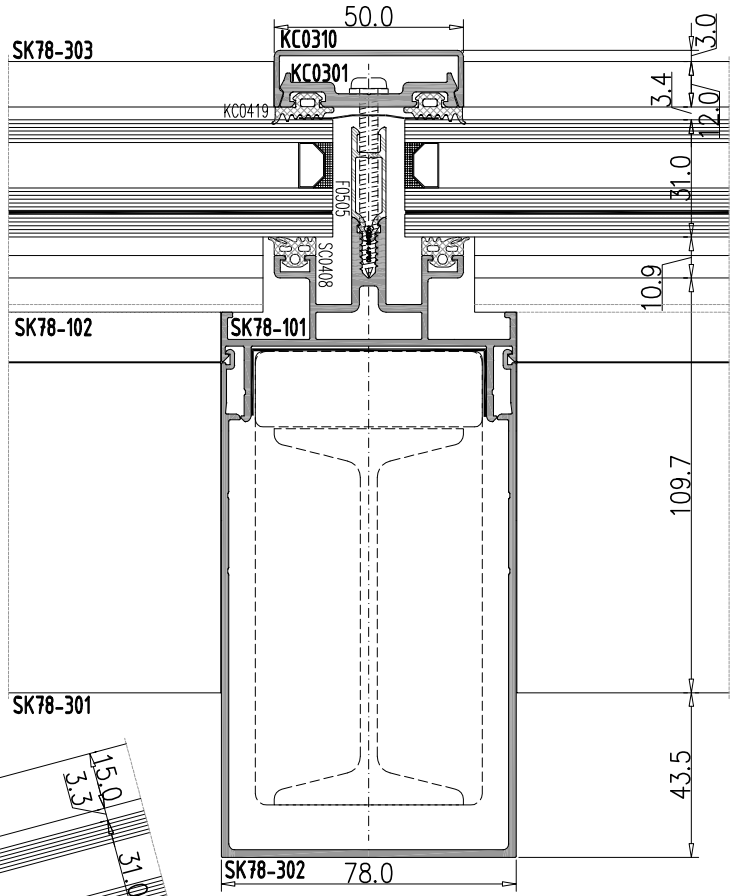
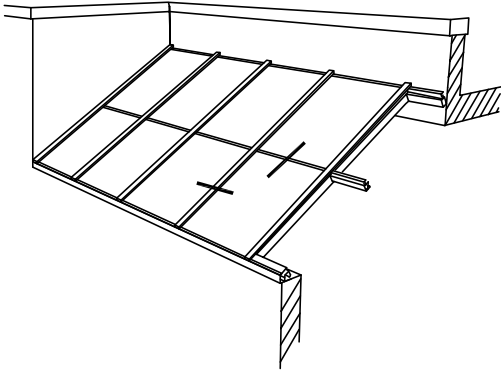

SKY78
İŞILIK SİSTEMİ
SKYLIGHT SYSTEMS

KÖŞE DETAY
CORNER DETAIL

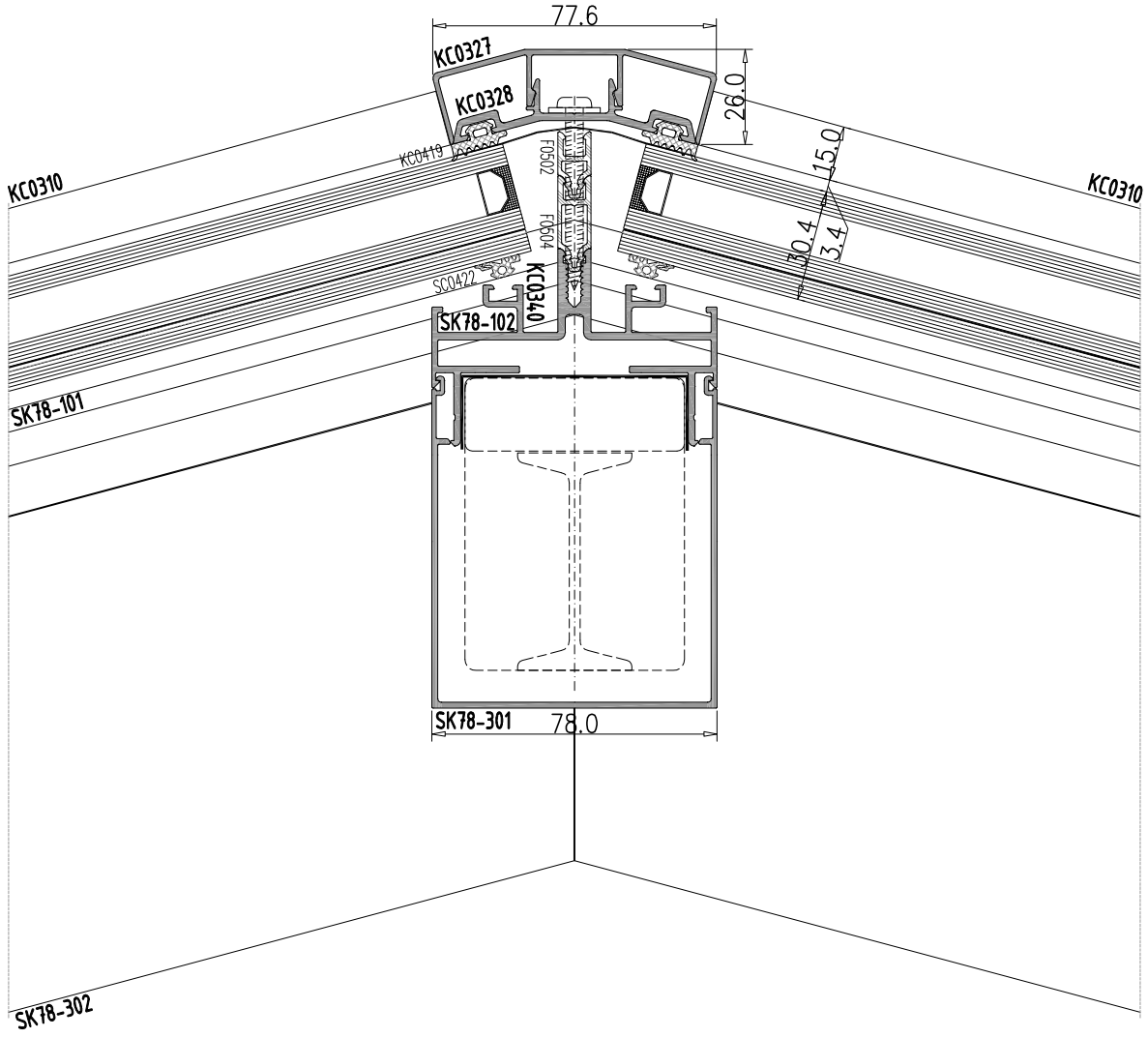
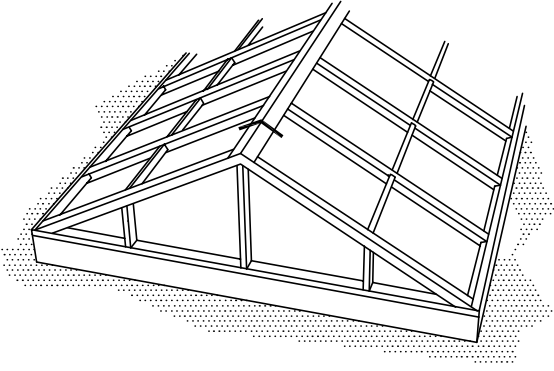

SKY78
İŞILIK SİSTEMİ
SKYLIGHT SYSTEMS

KÖŞE DETAY
CORNER DETAIL

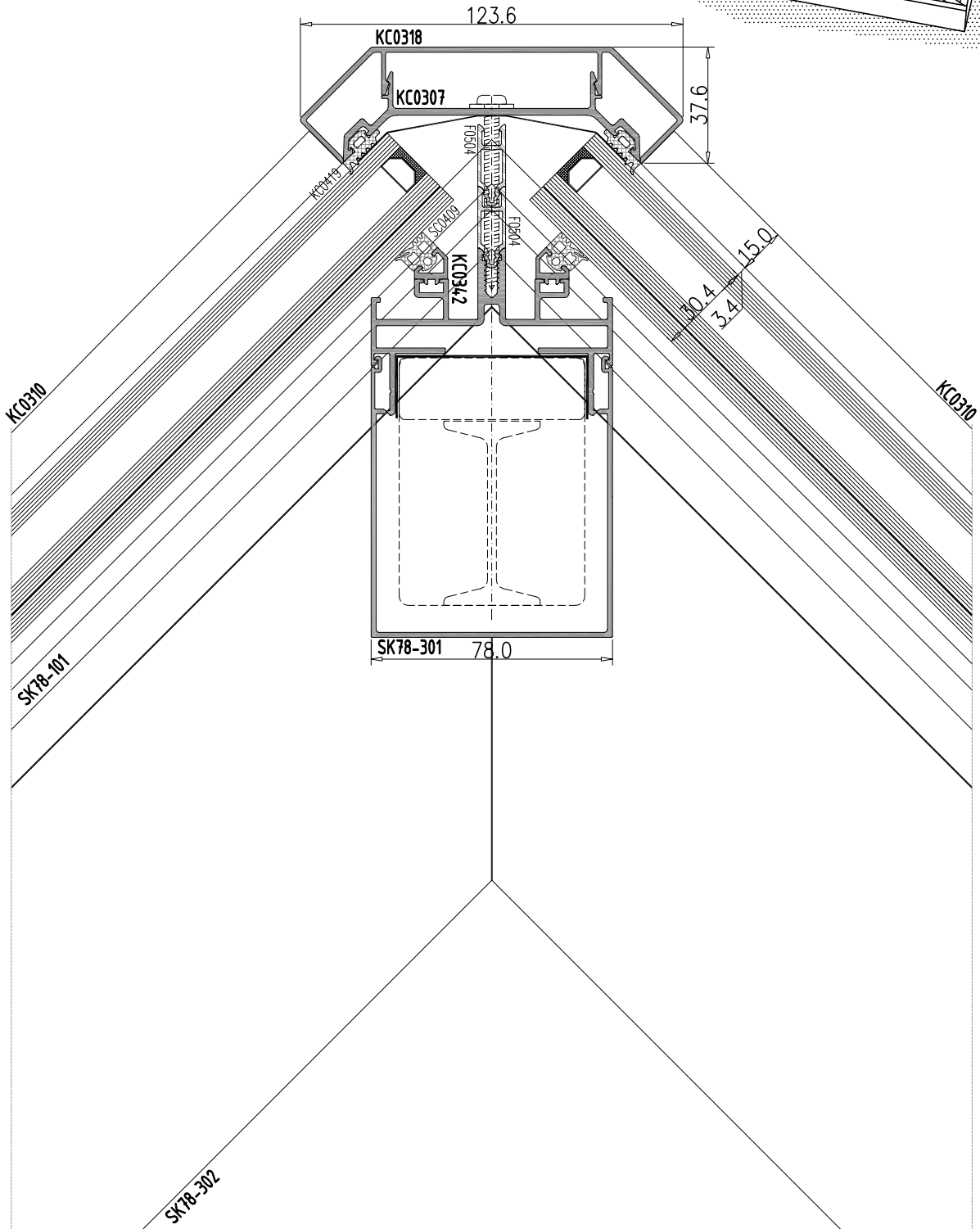
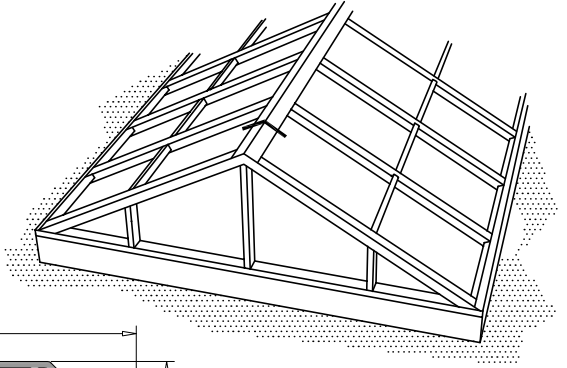

SKY78
İŞLİK SİSTEMİ
SKYLIGHT SYSTEMS

ALT BİTİM DETAY
BOTTOM CONNECTION DETAIL

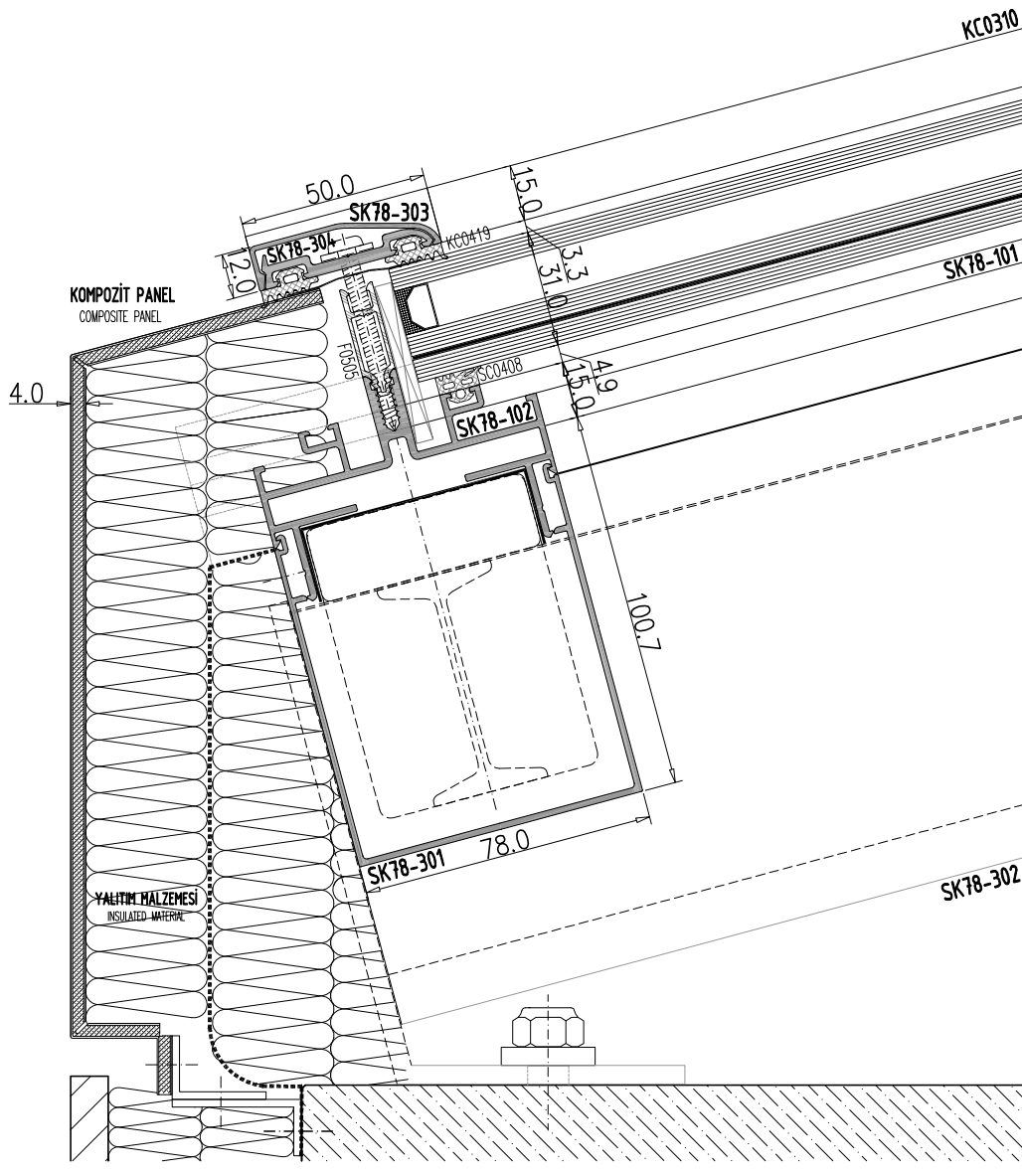
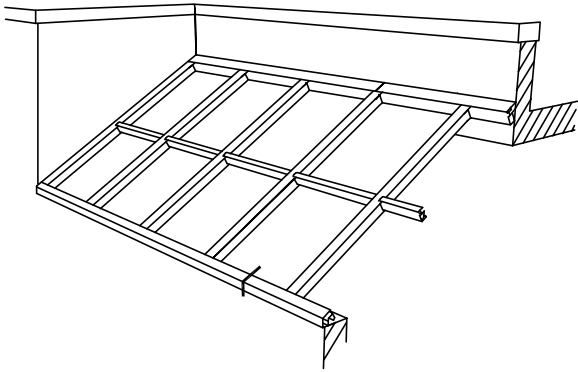

SKY78
İŞILIK SİSTEMİ
SKYLIGHT SYSTEMS

ÜST BİTİM DETAY
TOP CONNECTION DETAIL

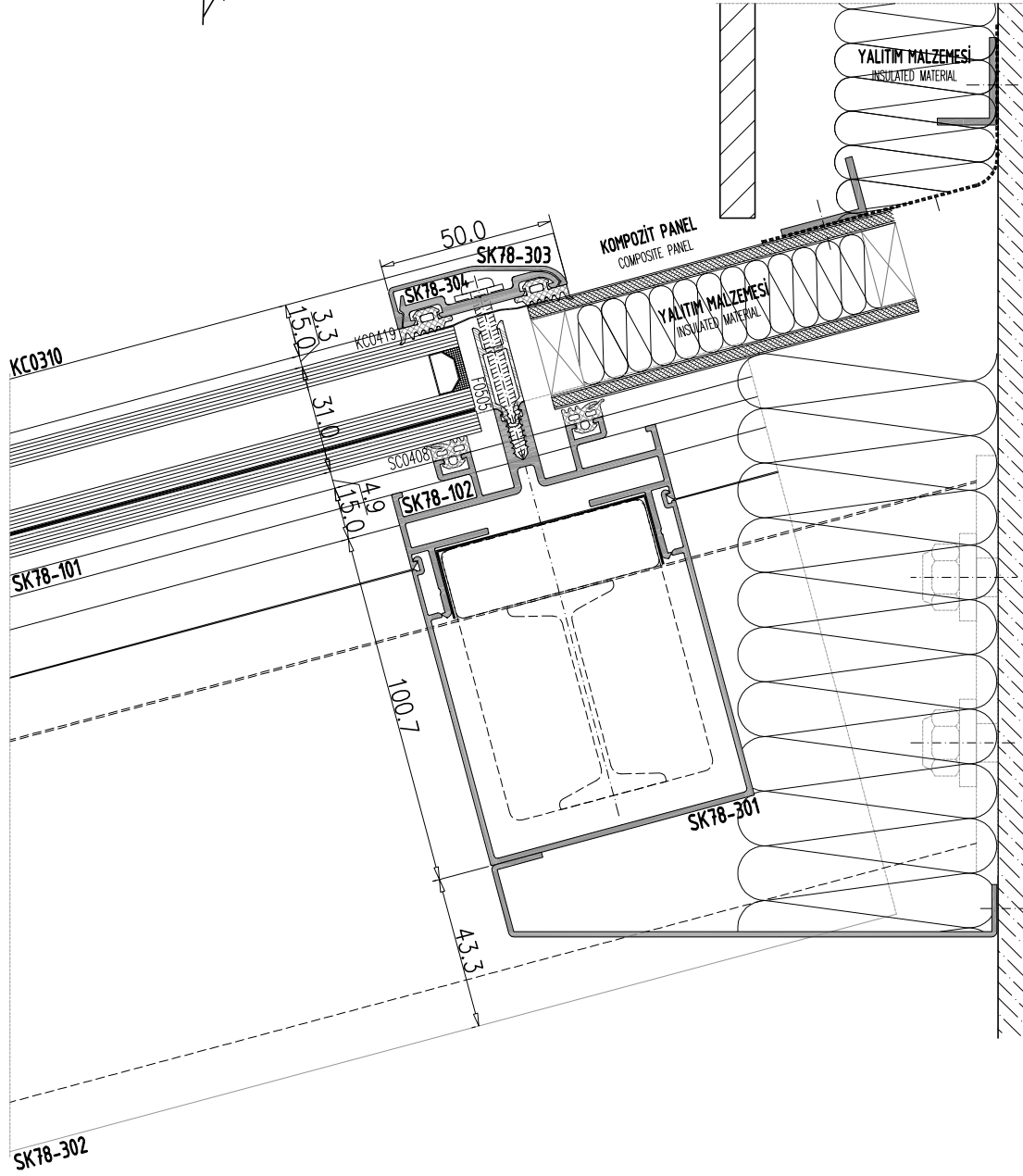
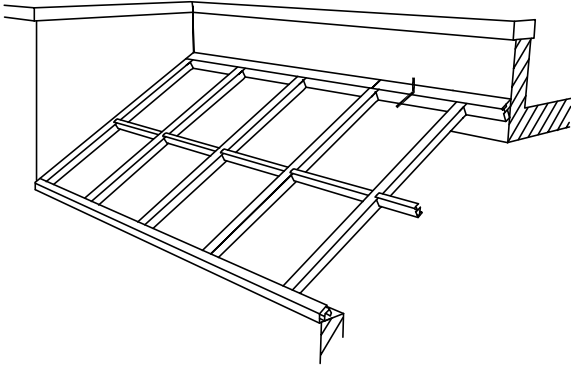

SKY78
İŞILIK SİSTEMİ
SKYLIGHT SYSTEMS

KÖŞE DETAY
CORNER DETAIL

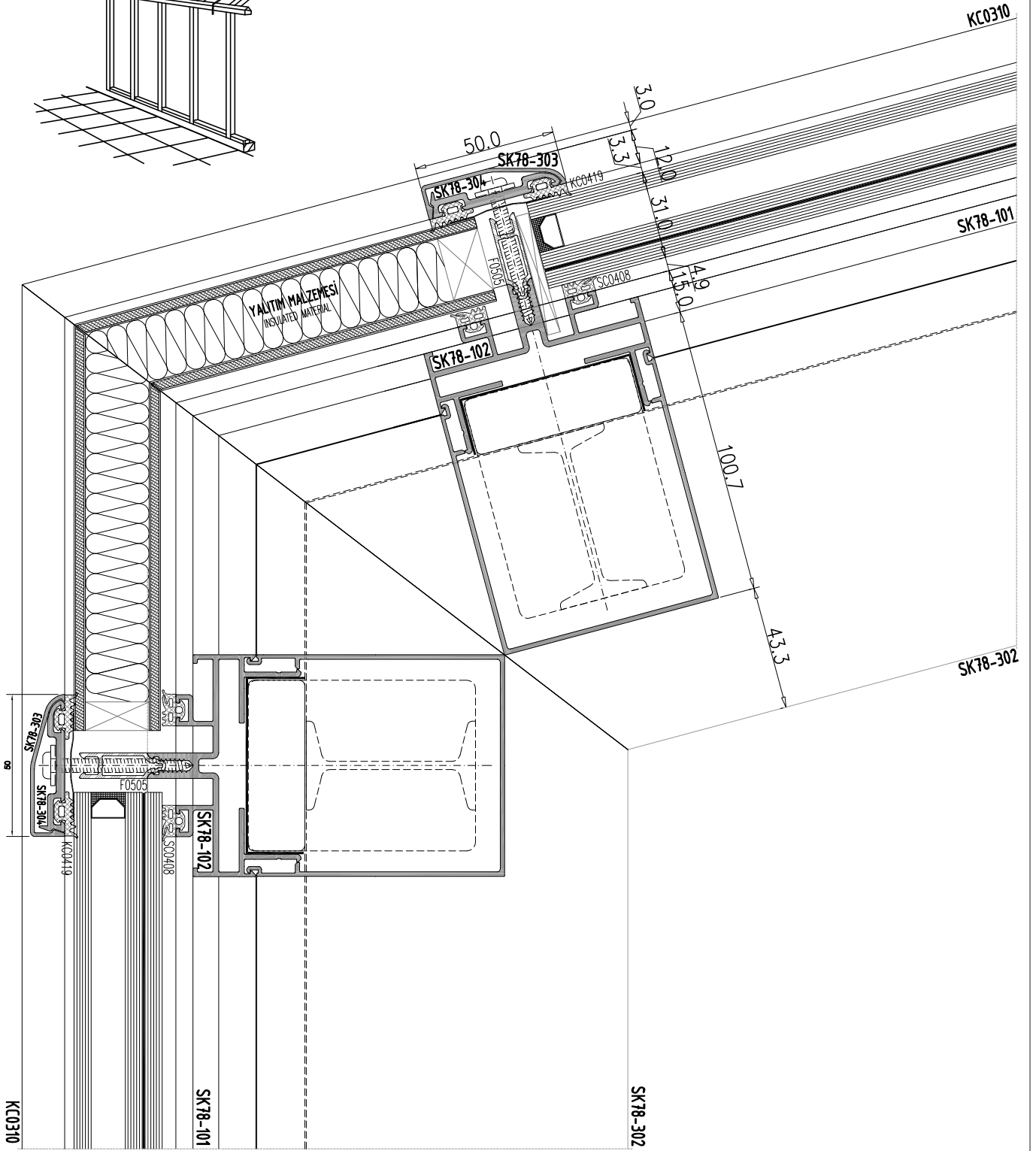
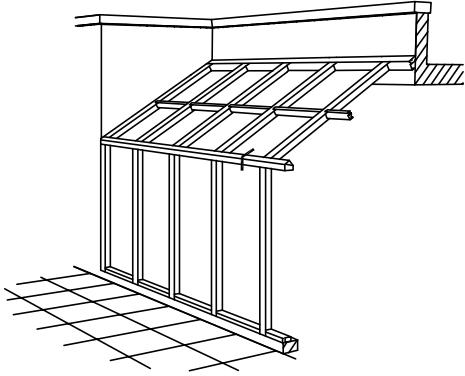

SKY78
İŞIKLIK SİSTEMİ
SKYLIGHT SYSTEMS

Fitil listesi
Gasket list

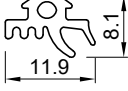
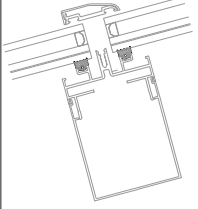
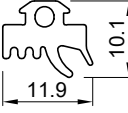
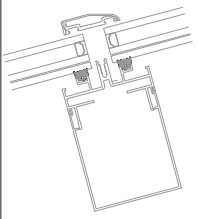
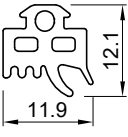
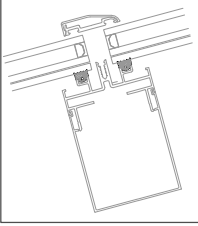
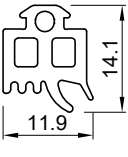
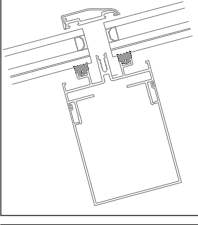
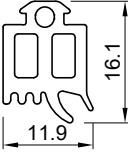
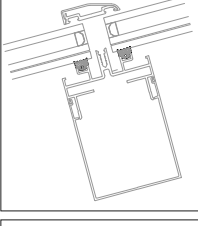
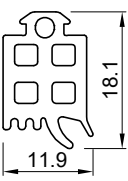
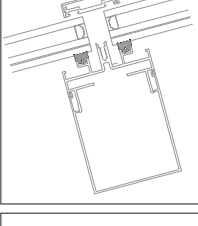
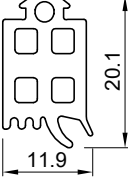
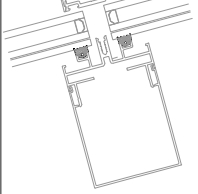
kod code	şekil drawing	tanım description	teorik ağırlık teoretical weight gr / m	paket ağırlığı package weight kg / package	paket metraji in one package metre / package	kullanım yeri aplication
SC0422		Taşıyıcı ve Panel iç fitili Mullion-transom or Panel gasket inside	46 gr/m	15 kg	326 m	
SC0407		Taşıyıcı ve Panel iç fitili Mullion-transom or Panel gasket inside	73 gr/m	15 kg	205 m	
SC0408		Taşıyıcı ve Panel iç fitili Mullion-transom or Panel gasket inside	88 gr/m	15 kg	170 m	
SC0409		Taşıyıcı ve Panel iç fitili Mullion-transom or Panel gasket inside	101 gr/m	15 kg	148 m	
SC0410		Taşıyıcı ve Panel iç fitili Mullion-transom or Panel gasket inside	113 gr/m	15 kg	133 m	
SC0411		Taşıyıcı ve Panel iç fitili Mullion-transom or Panel gasket inside	144 gr/m	15 kg	104 m	
SC0420		Taşıyıcı ve Panel iç fitili Mullion-transom or Panel gasket inside	167 gr/m	15 kg	90 m	



SKY78
İŞIKLIK SİSTEMİ
SKYLIGHT SYSTEMS

Fitil listesi
Gasket list

kod code	şekil drawing	tanım description	teorik ağırlık teoretical weight gr / m	paket ağırlığı package weight kg / package	paket metrajı in one package metre / package	kullanım yeri aplication
SC0421		Taşıyıcı ve Panel iç fitili Mullion-transom or Panel gasket inside	189 gr/m	15 kg	79 m	
SC0425		Taşıyıcı ve Panel iç fitili Mullion-transom or Panel gasket inside	217,6 gr/m	15 kg	69 m	
KC0409		Taşıyıcı ve Panel iç fitili Mullion-transom or Panel gasket inside	249 gr/m	15 kg	60 m	
KC0419		Baskı profil fitili Glazing gasket	73 gr/m	15 kg	205 m	
EC0401		Poliüretan dolgu polyurethane gasket	-	-	6 m	
SK-710		cam iç fitil glazing gasket inside	45 gr/m	15 kg	333 m	
W1-703		Kasa fitili Frame gasket	33 gr/m	15 kg	440 m	

SKY78
İŞIKLIK SİSTEMİ
SKYLIGHT SYSTEMS

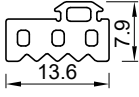
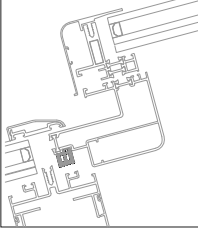
Fitil listesi
Gasket list

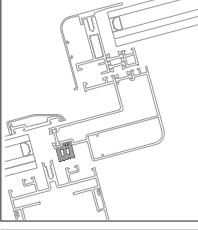
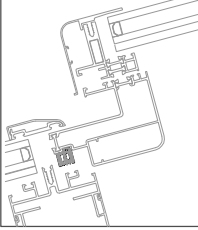
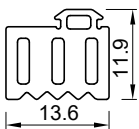
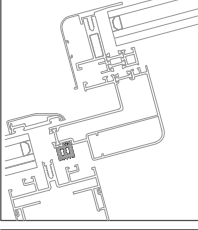
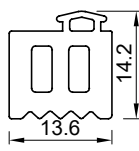
kod code	şekil drawing	tanım description	teorik ağırlık theoretical weight gr / m	paket ağırlığı package weight kg / package	paket metraji in one package metre / package	kullanım yeri aplication
W-708		Profil iç fitil Profile gasket inside	91 gr/m	15 kg	165 m	
W-711		Profil iç fitil Profile gasket inside	65 gr/m	15 kg	230 m	
W-712		Profil iç fitil Profile gasket inside	110 gr/m	15 kg	135 m	
W-713		Profil iç fitil Profile gasket inside	135 gr/m	15 kg	110 m	
W-714		Profil iç fitil Profile gasket inside	166 gr/m	15 kg	90 m	

SKY78
İŞIKLIK SİSTEMİ
SKYLIGHT SYSTEMS

Pvc ızalasyon listesi
Pvc ızalator list

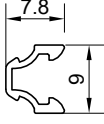
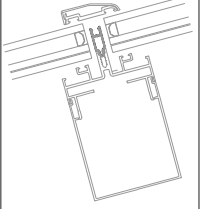
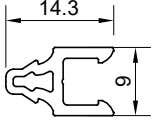
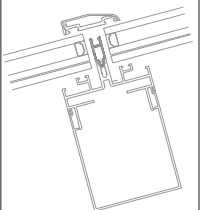
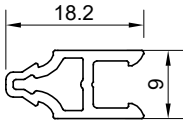
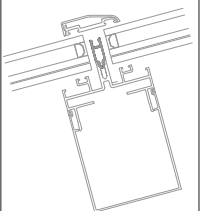
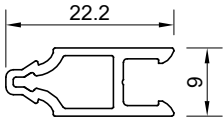
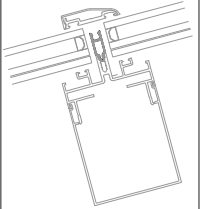
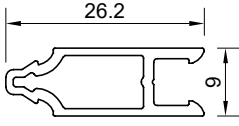
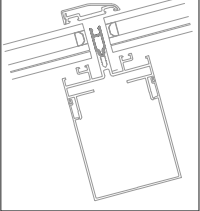
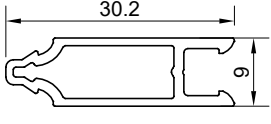
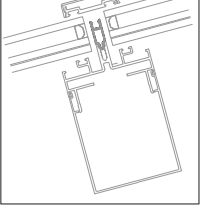
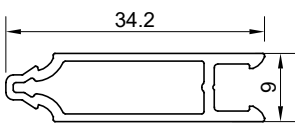
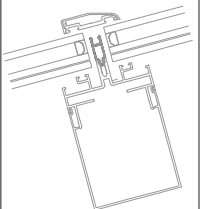
kod code	şekil drawing	tanım description	metraji metre / package	kullanım yeri aplication
F0500		Taşıyıcı ön ızalasyon (pvc) Mullion or transom front ızalator (pvc)	6 m	
F0501		Taşıyıcı ön ızalasyon (pvc) Mullion or transom front ızalator (pvc)	6 m	
F0502		Taşıyıcı ön ızalasyon (pvc) Mullion or transom front ızalator (pvc)	6 m	
F0503		Taşıyıcı ön ızalasyon (pvc) Mullion or transom front ızalator (pvc)	6 m	
F0504		Taşıyıcı ön ızalasyon (pvc) Mullion or transom front ızalator (pvc)	6 m	
F0505		Taşıyıcı ön ızalasyon (pvc) Mullion or transom front ızalator (pvc)	6 m	
F0506		Taşıyıcı ön ızalasyon (pvc) Mullion or transom front ızalator (pvc)	6 m	

SKY78
İŞILIK SİSTEMİ
SKYLIGHT SYSTEMS

İMALAT ŞEMASI
PRODUCTION PLAN

KASA-KANAT İMALAT BOYU

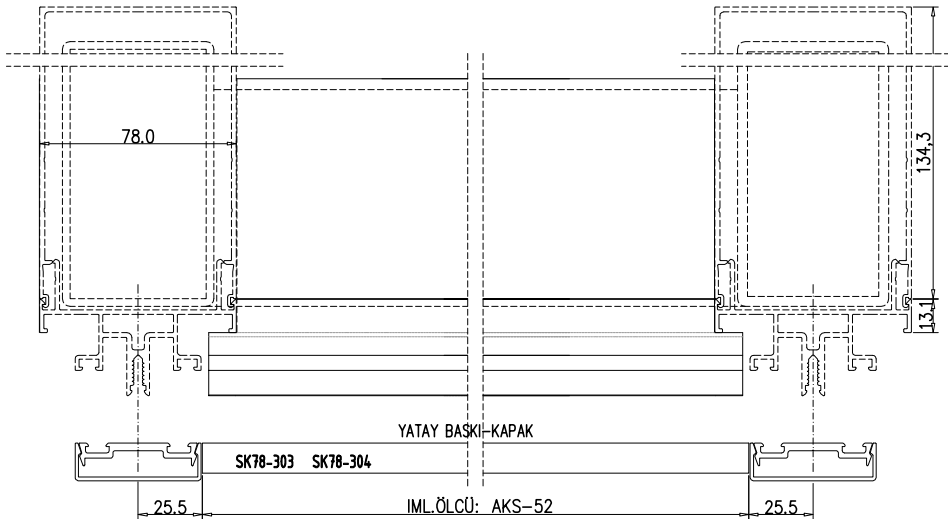
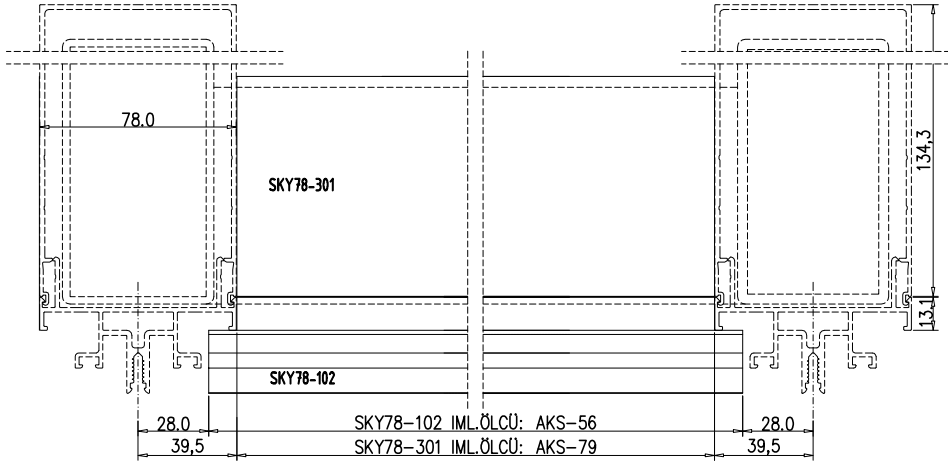
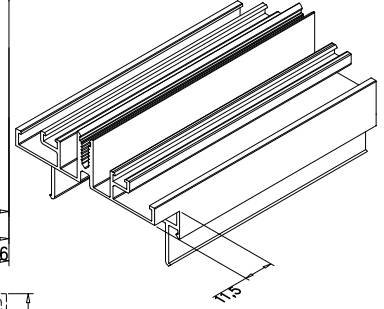
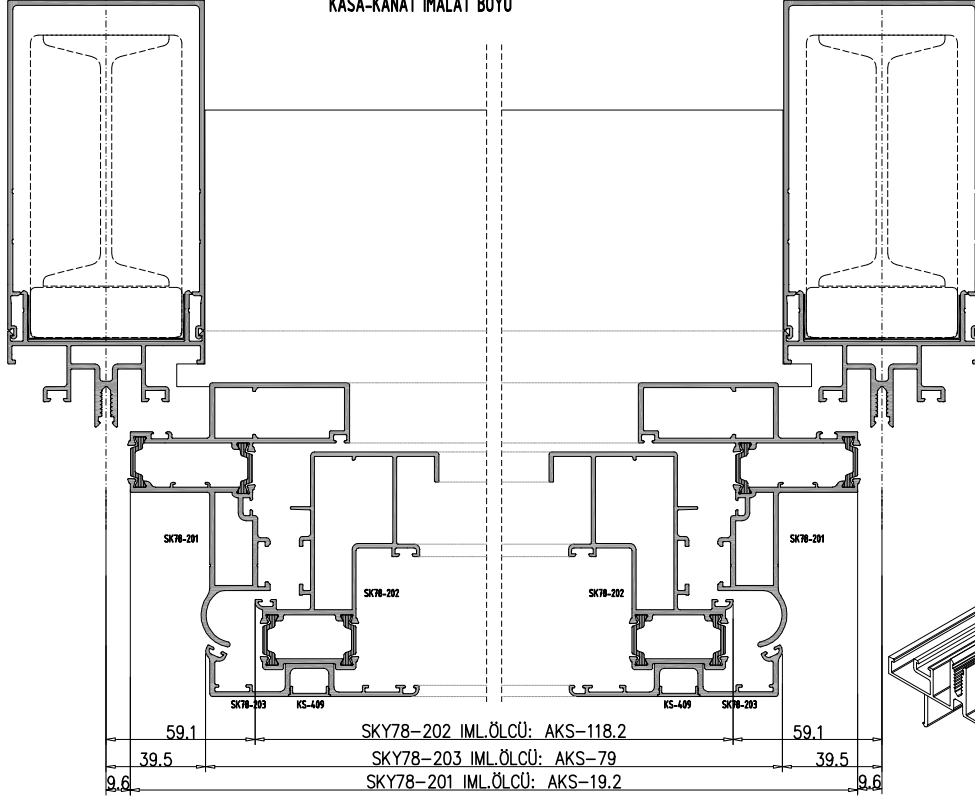

SKY78
İŞILIK SİSTEMİ
SKYLIGHT SYSTEMS

AKSESUARLAR
ACCESSOIRES

WORM EDGE KÖŞE BİRLEŞTİRME (PVC)
WORM EDGE CORNER JOINING (PVC)

EC0303 (yerli) (native)

