

SÜRME SERİ

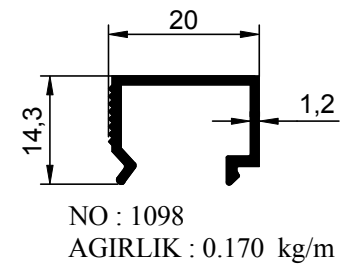

SÜRME SERİ

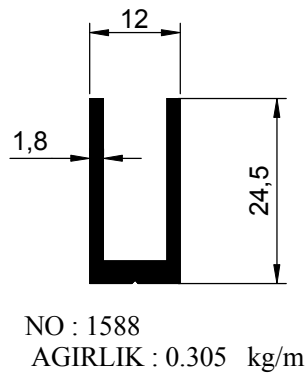
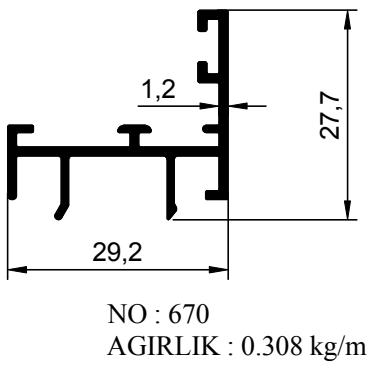
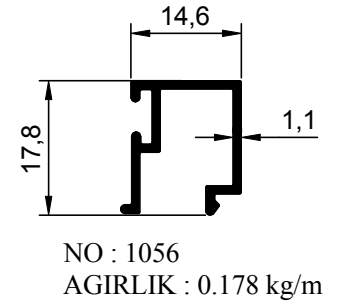
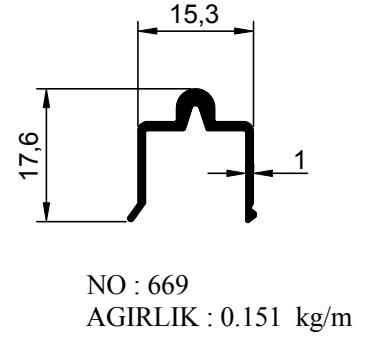
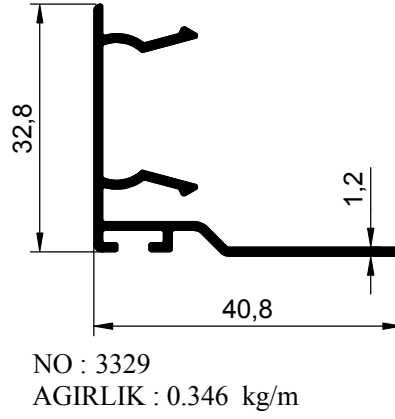
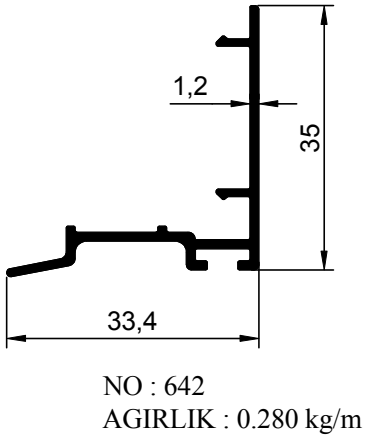
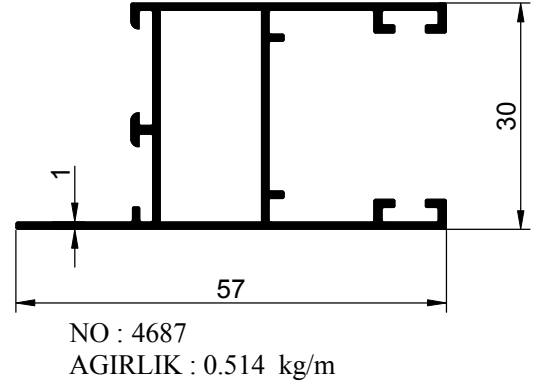
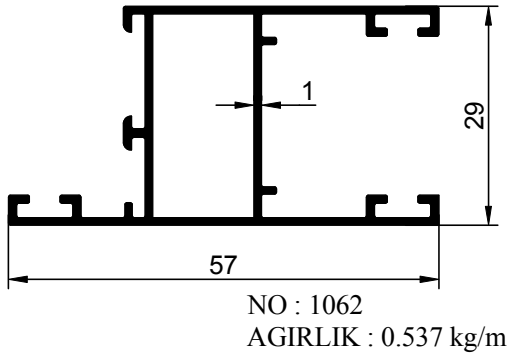
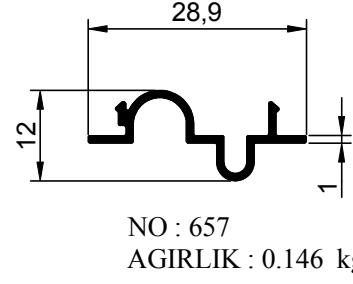
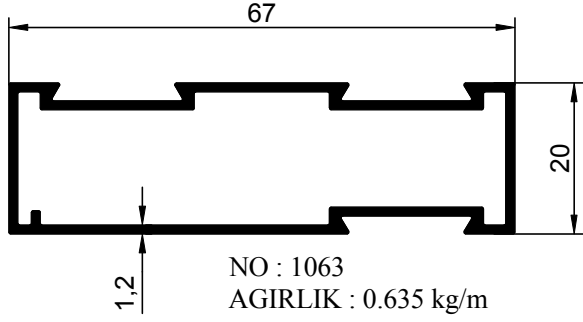
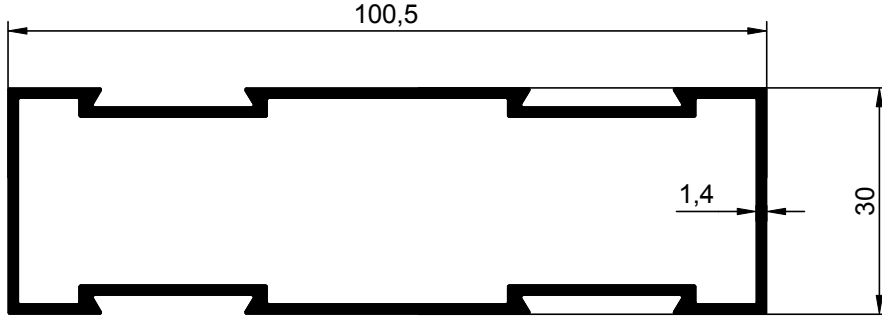

NO : 1446 AGIRLIK : 1.096 kg/m

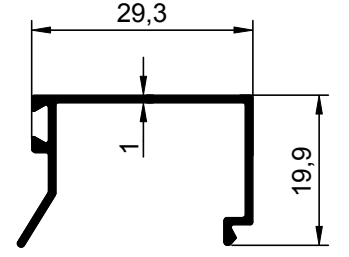

NO : 599
AGIRLIK : 0.209 kg/m

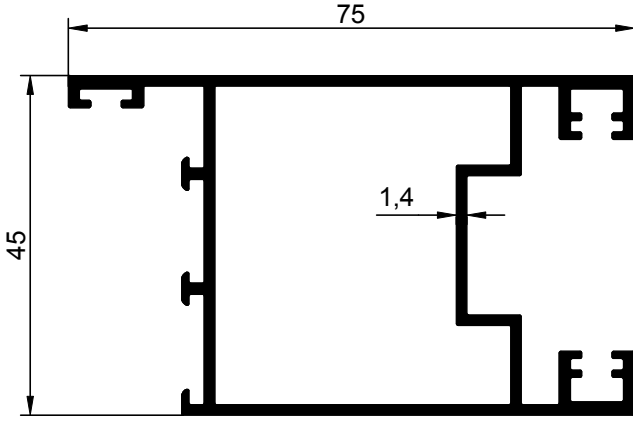

NO : 1447 AGIRLIK : 1.129 kg/m

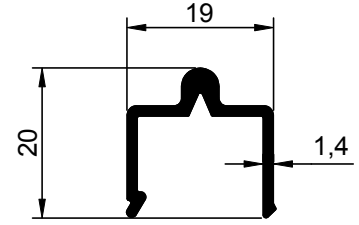

NO : 1456
AGIRLIK : 0.224 kg/m

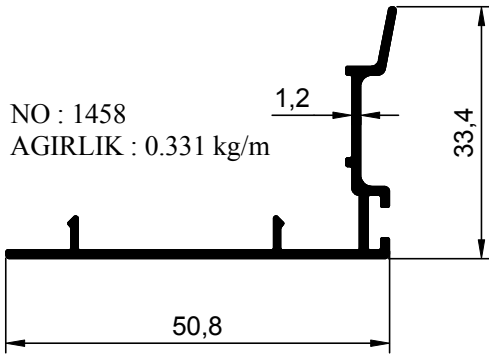

NO : 1458
AGIRLIK : 0.331 kg/m

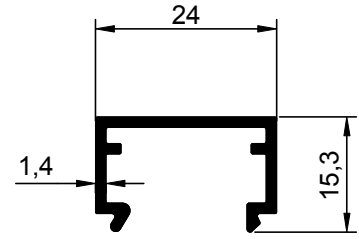

NO : 1457
AGIRLIK : 0.232 kg/m

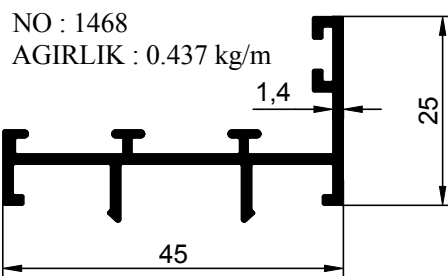

NO : 1468
AGIRLIK : 0.437 kg/m

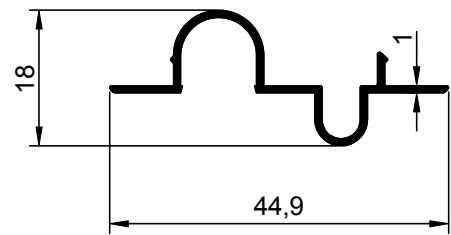

NO : 1666
AGIRLIK : 0.205 kg/m

SÜRME SERİ

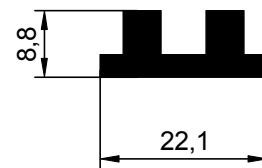
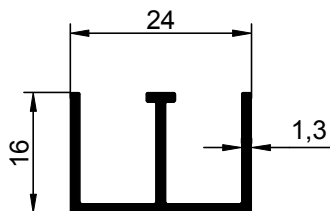
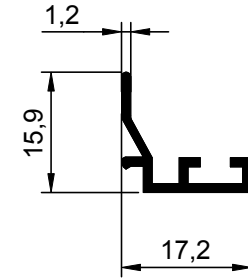
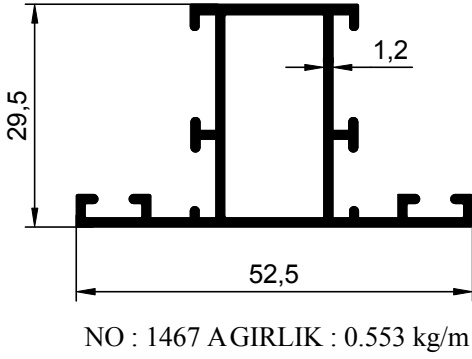
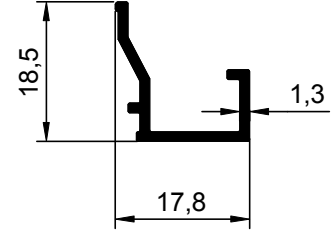
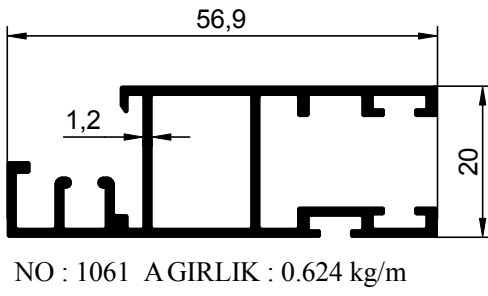
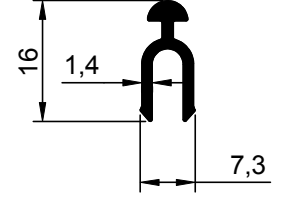
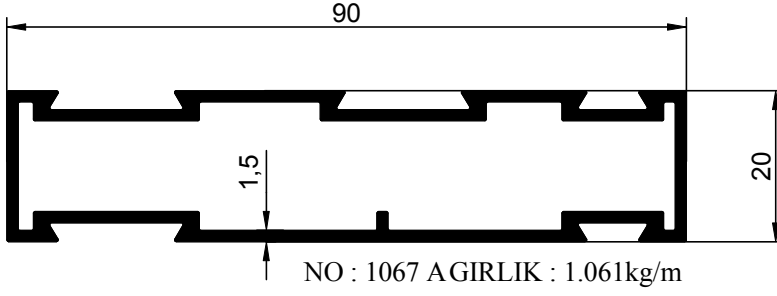

SÜRME SERİ

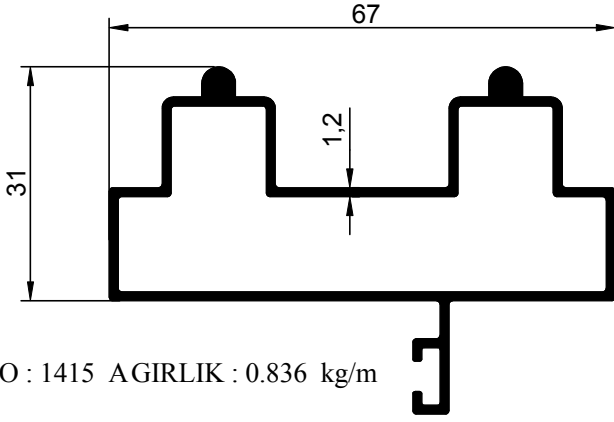

NO : 1415 AGIRLIK : 0.836 kg/m

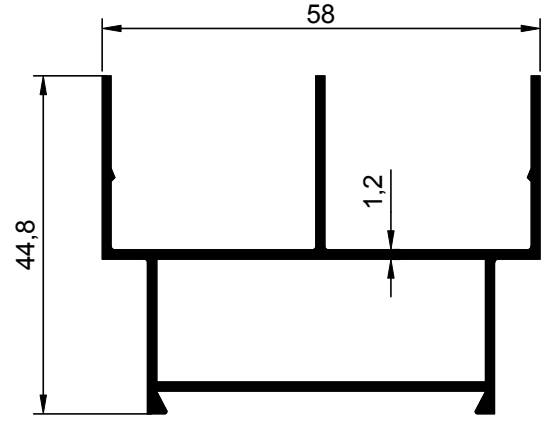

NO : 2552 AGIRLIK : 0.718 kg/m

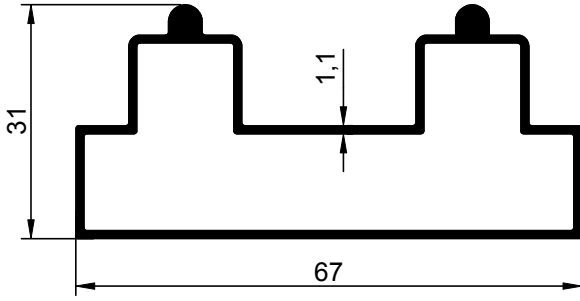

NO : 2511 AGIRLIK : 0.697 kg/m

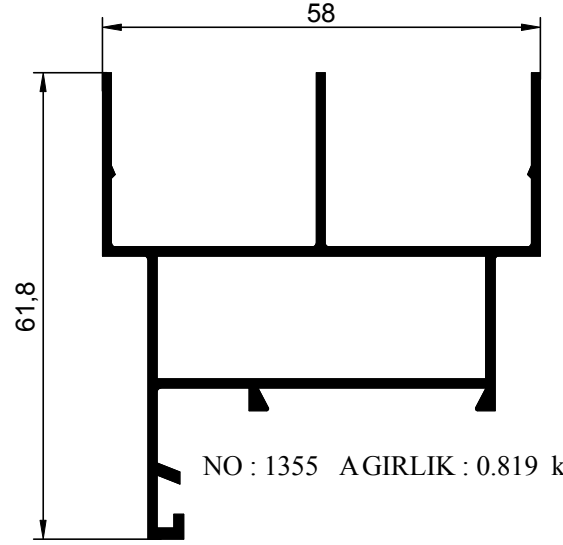

NO : 1355 AGIRLIK : 0.819 kg/m

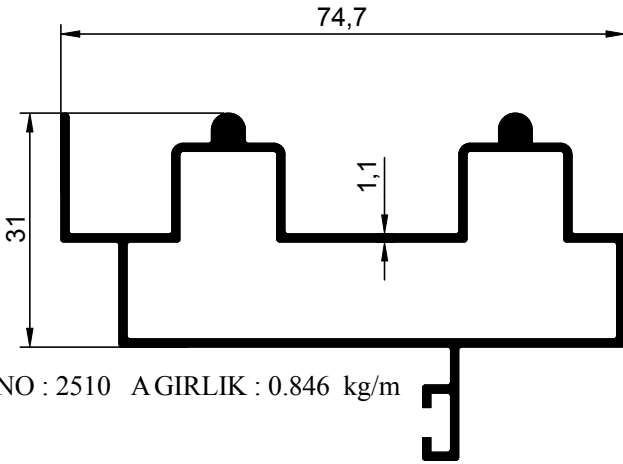

NO : 2510 AGIRLIK : 0.846 kg/m

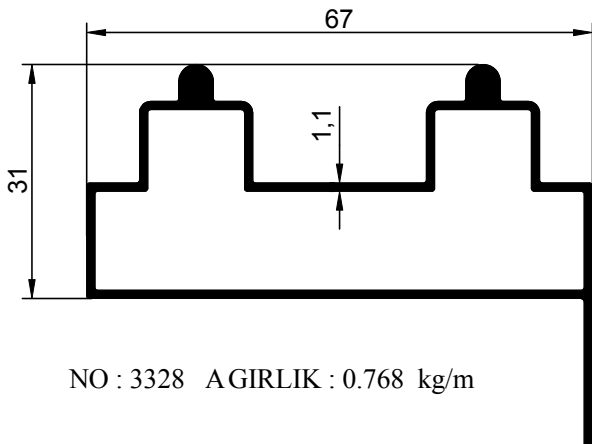

NO : 3328 AGIRLIK : 0.768 kg/m

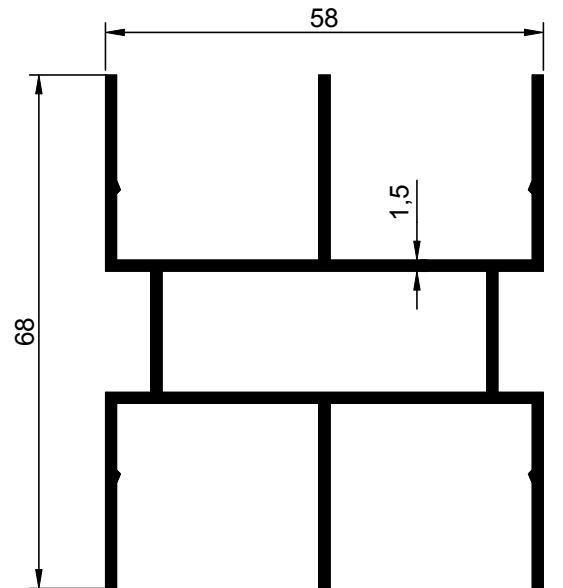

NO : 1356 AGIRLIK : 1.195 kg/m

SÜRME SERİ

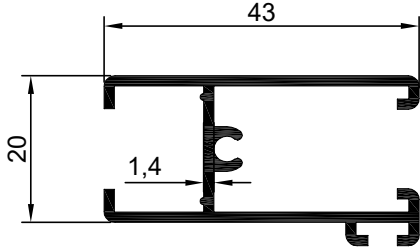

NO : 1358 AGIRLIK : 0.508 kg/m

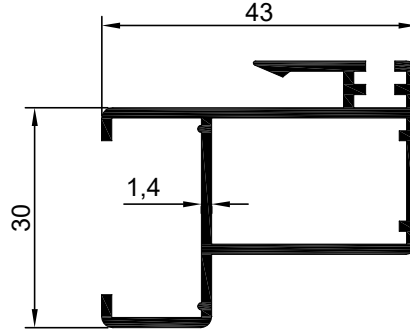

NO : 1363
AGIRLIK : 0.637 kg/m

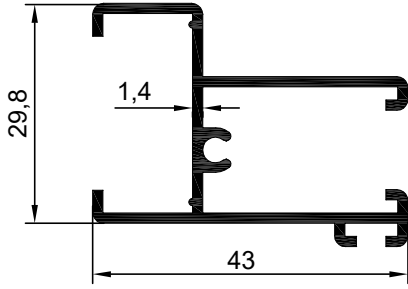

NO : 1359 AGIRLIK : 0.544 kg/m

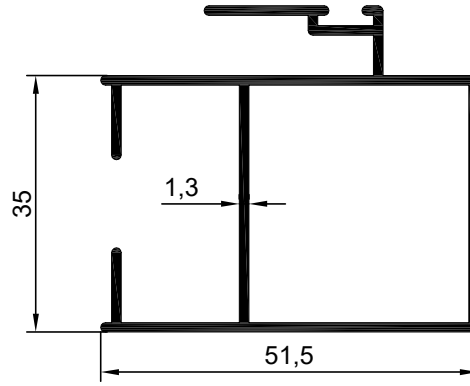

NO : 1883
AGIRLIK : 0.788 kg/m

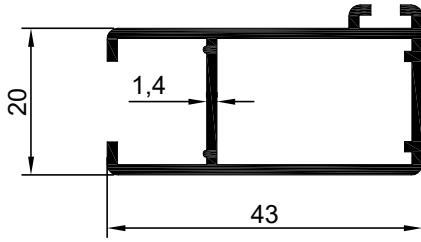

NO : 1360 AGIRLIK : 0.516 kg/m

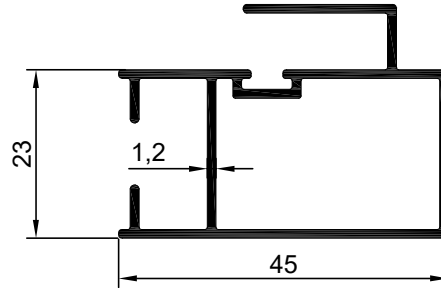

NO : 1889
AGIRLIK : 0.589 kg/m

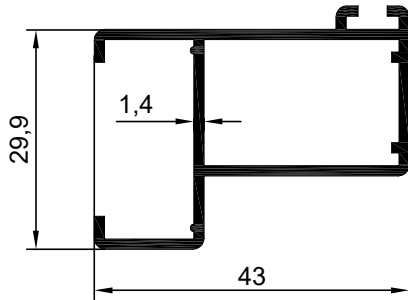

NO : 1361 AGIRLIK : 0.553 kg/m

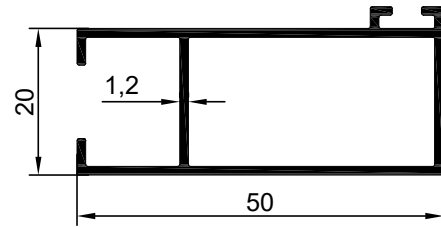

NO : 1615
AGIRLIK : 0.494 kg/m

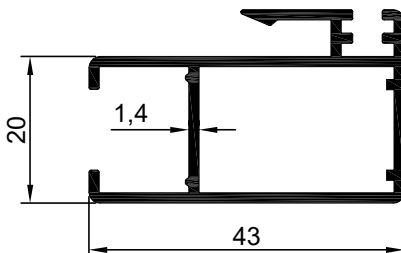

NO : 1362 AGIRLIK : 0.603 kg/m

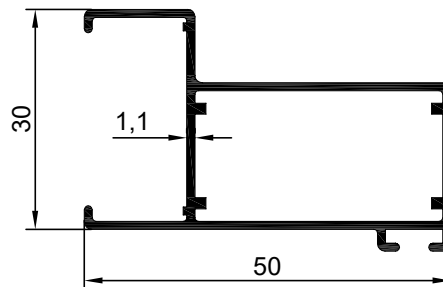

NO : 1617
AGIRLIK : 0.497kg/m

SÜRME SERİ

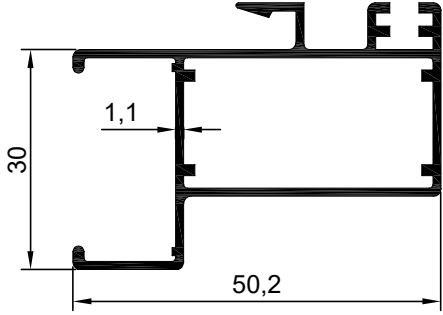

NO : 1618 AGIRLIK : 0.589 kg/m

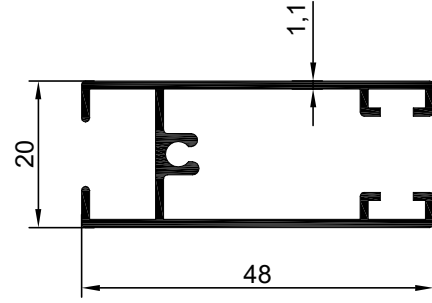

NO : 1884 AGIRLIK : 0.464 kg/m

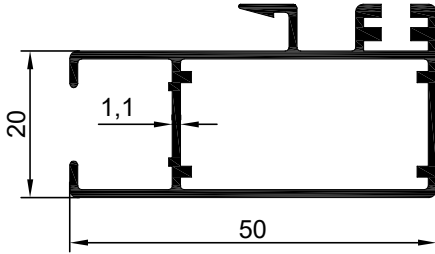

NO : 1619 AGIRLIK : 0.575 kg/m

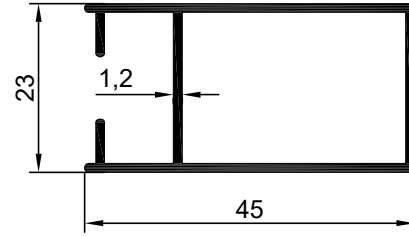

NO : 1888 AGIRLIK : 0.462 kg/m

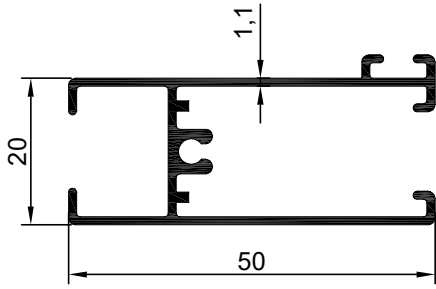

NO : 1620 AGIRLIK : 0.489 kg/m

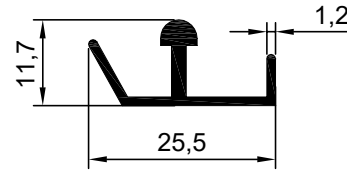

NO : 1616 AGIRLIK : 0.193 kg/m

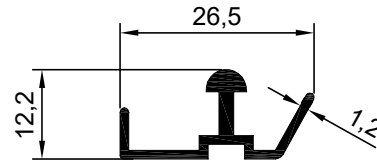

NO : 1364 AGIRLIK : 0.200 kg/m

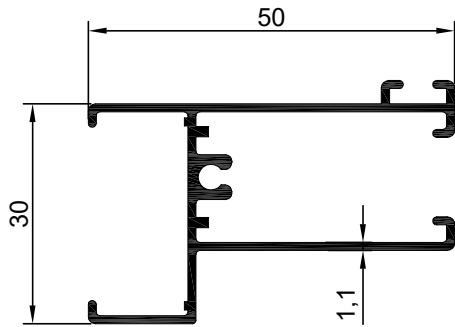

NO : 1621 AGIRLIK : 0.511 kg/m

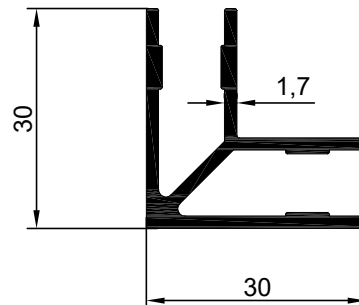

NO : 1546 AGIRLIK : 0.532 kg/m

SÜRME SERİ

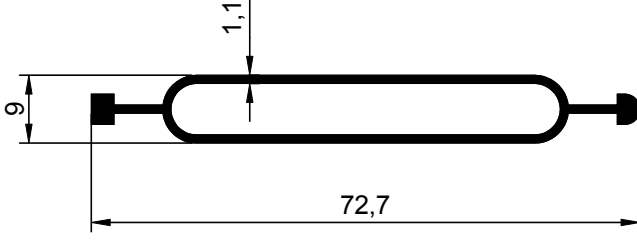

NO : 1128 AGIRLIK : 0.437 kg/m

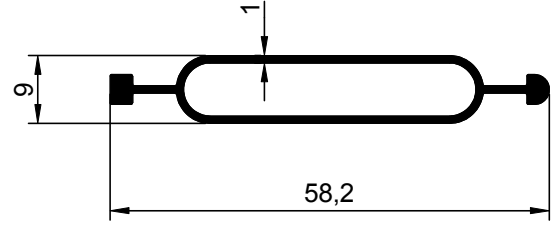

NO : 800 AGIRLIK : 0.330 kg/m

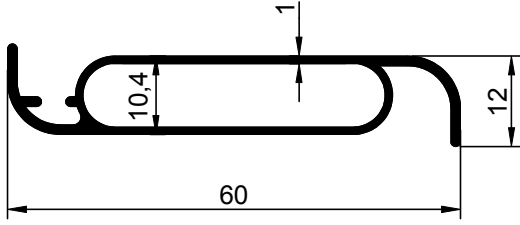

NO : 1885 AGIRLIK : 0.402 kg/m

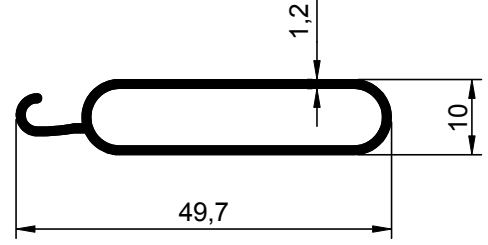

NO : 957 AGIRLIK : 0.333 kg/m

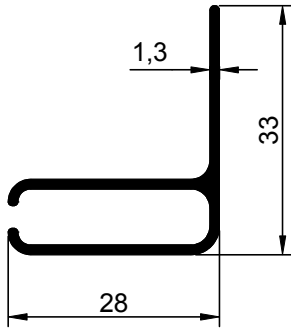

NO : 1057 AGIRLIK : 0.312 kg/m

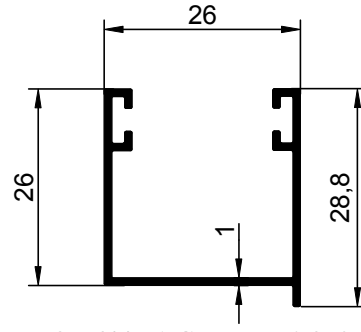

NO : 644 AGIRLIK : 0.259 kg/m

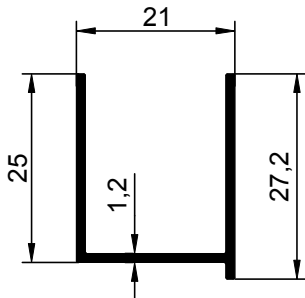

NO : 948 AGIRLIK : 0.229 kg/m

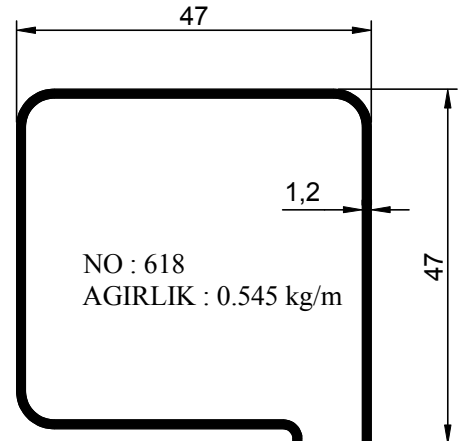

NO : 618
AGIRLIK : 0.545 kg/m