

ASANSÖR PROFİLLERİ

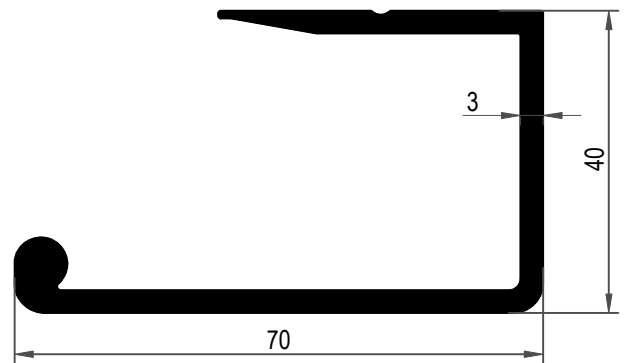

ASANSÖR PROFİLLERİ

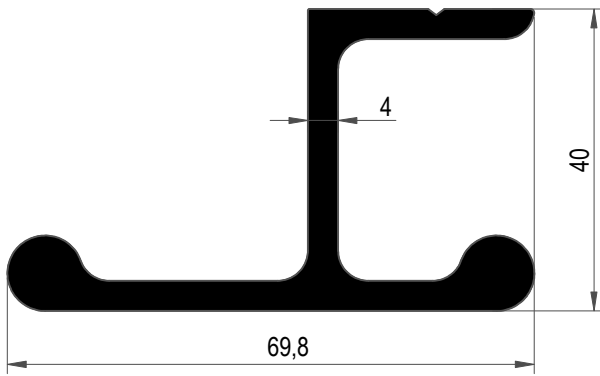
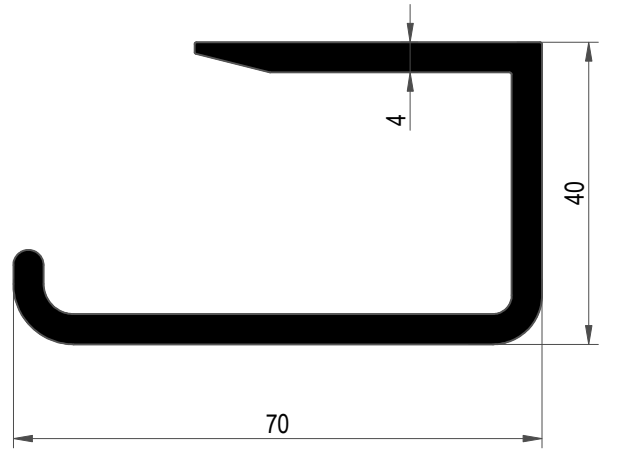
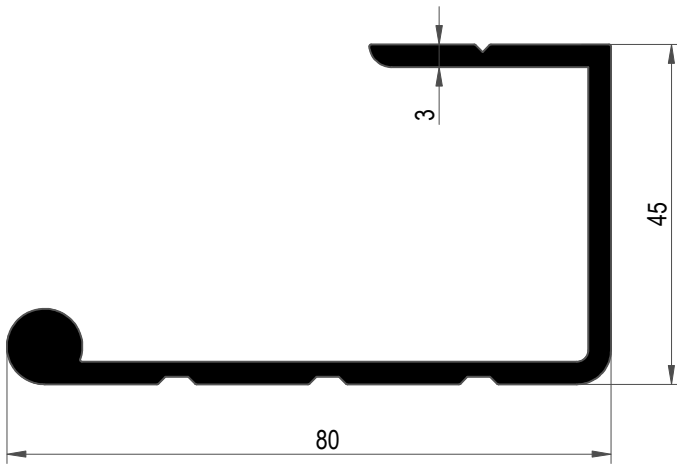
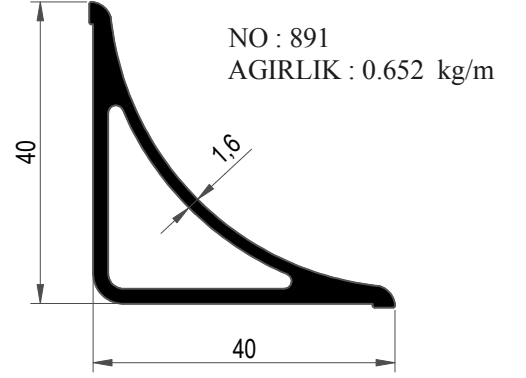
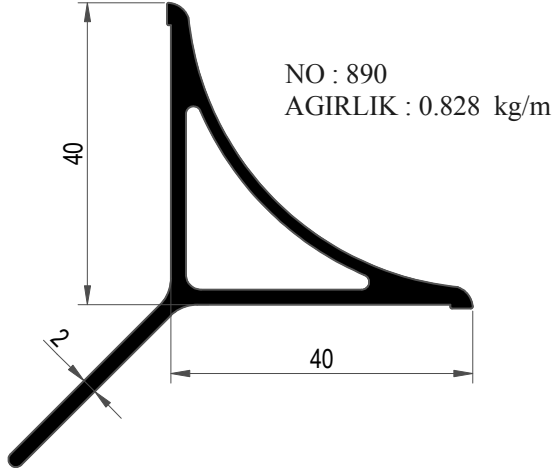
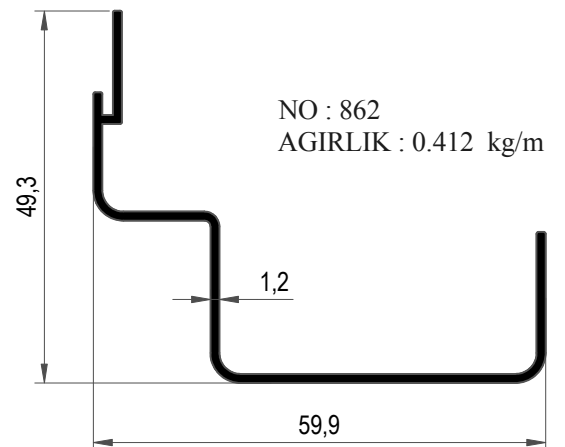
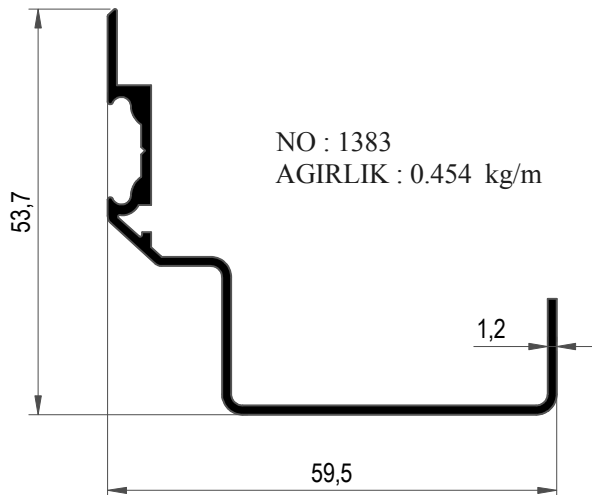
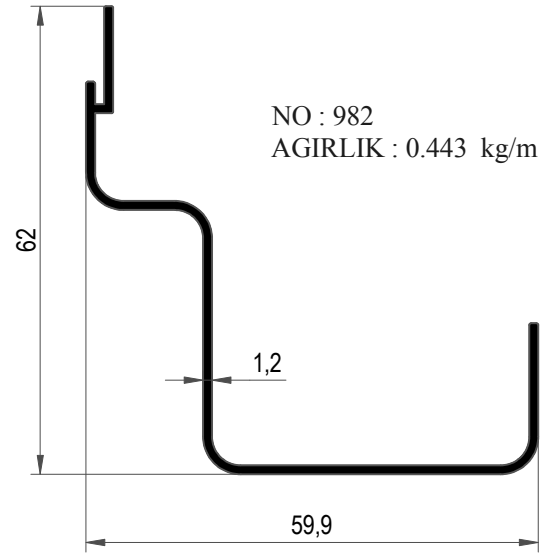
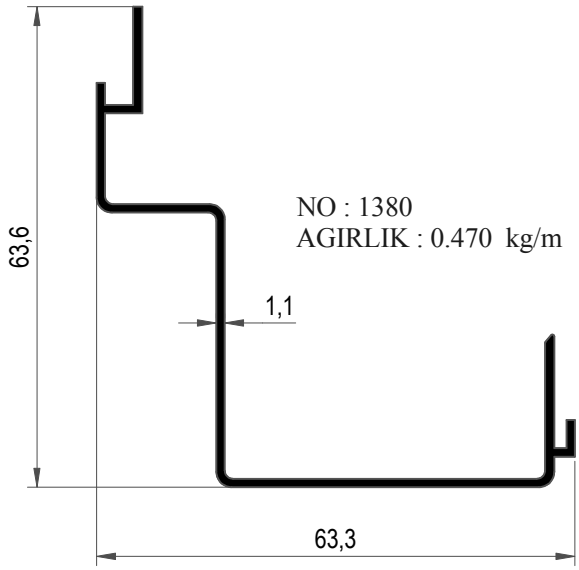
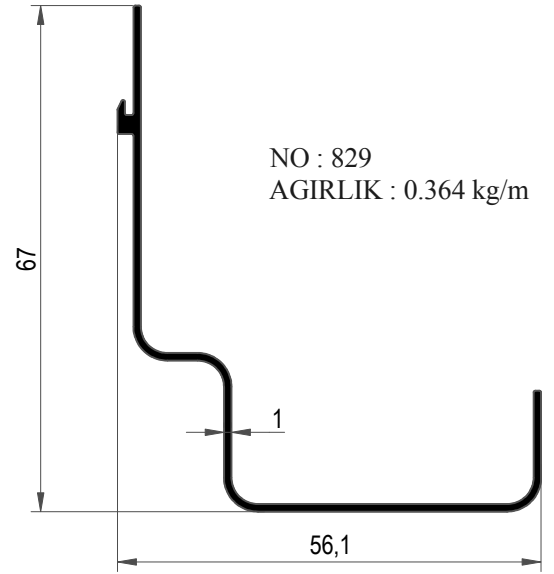
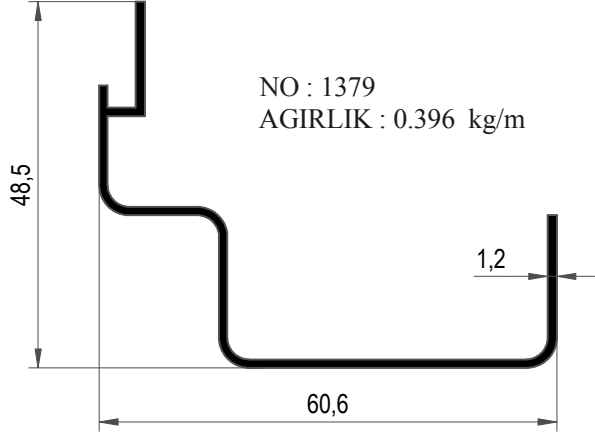

ASANSÖR PROFİLLERİ

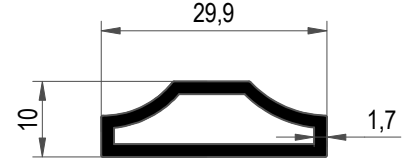
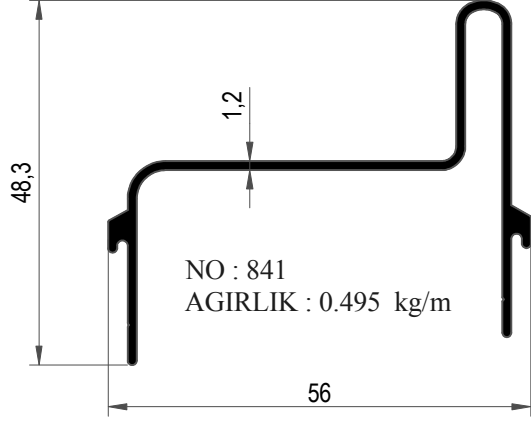

NO : 844 AGIRLIK : 0.304 kg/m

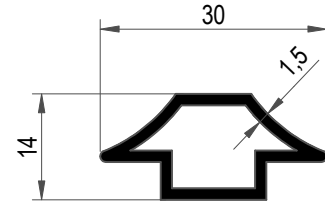

NO : 1375 AGIRLIK : 0.284 kg/m

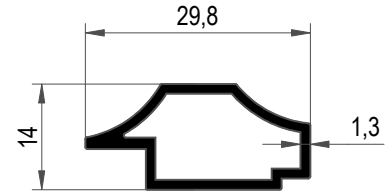
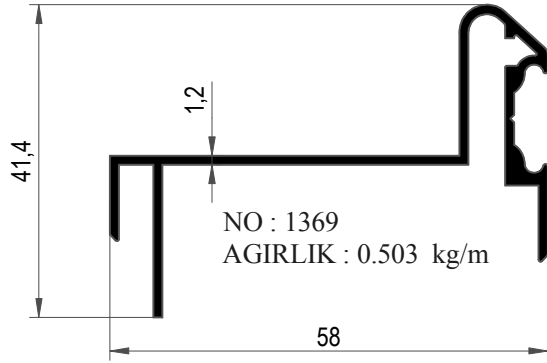

NO : 845 AGIRLIK : 0.261 kg/m

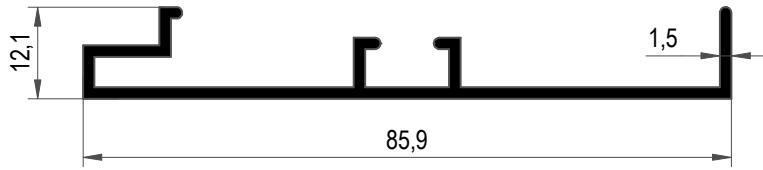

NO : 1766 AGIRLIK : 0.553 kg/m

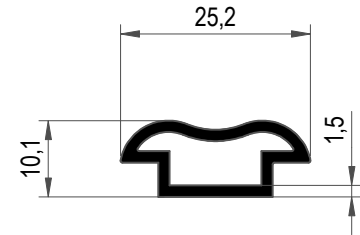

NO : 1368 AGIRLIK : 0.243 kg/m

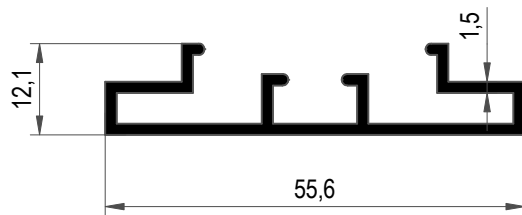

NO : 1765 AGIRLIK : 0.477 kg/m

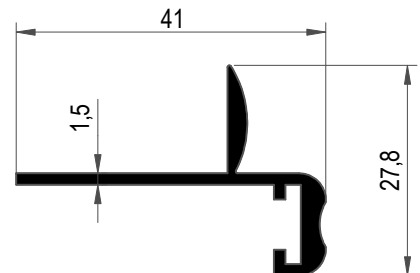

NO : 1371 AGIRLIK : 0.359 kg/m

ASANSÖR PROFİLLERİ

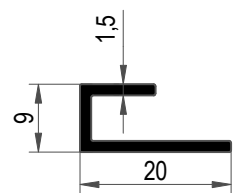
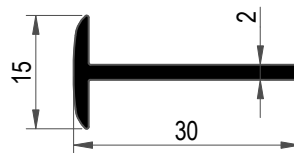
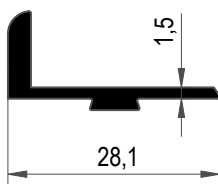
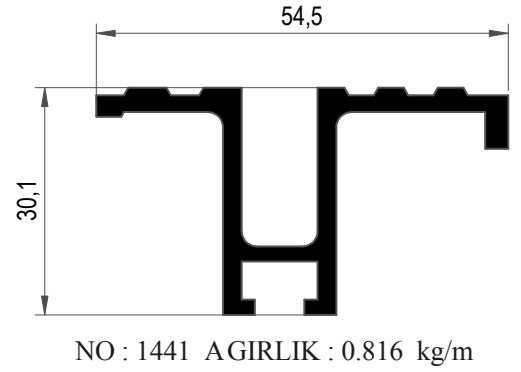
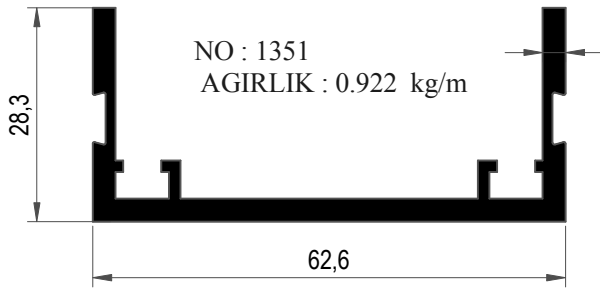
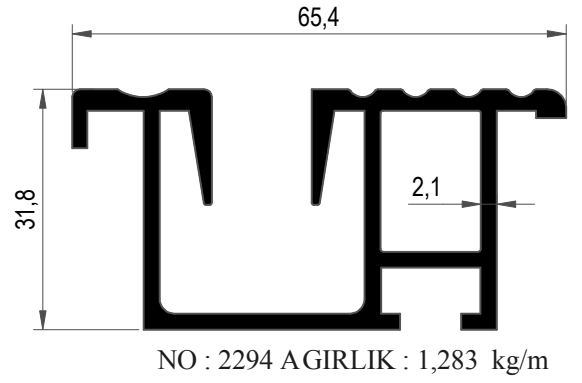
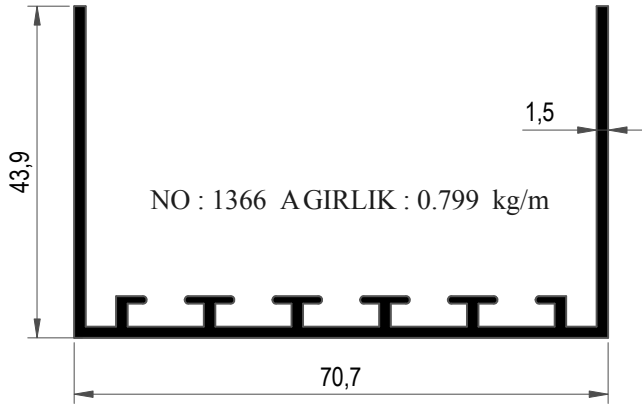
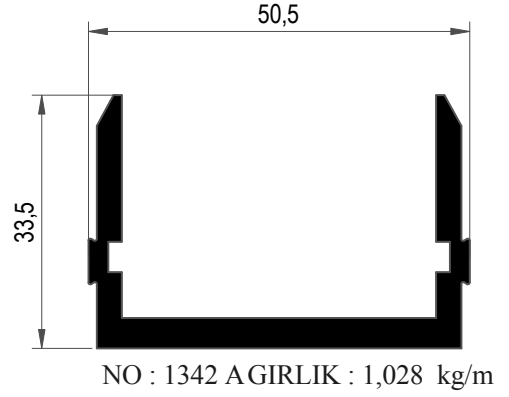
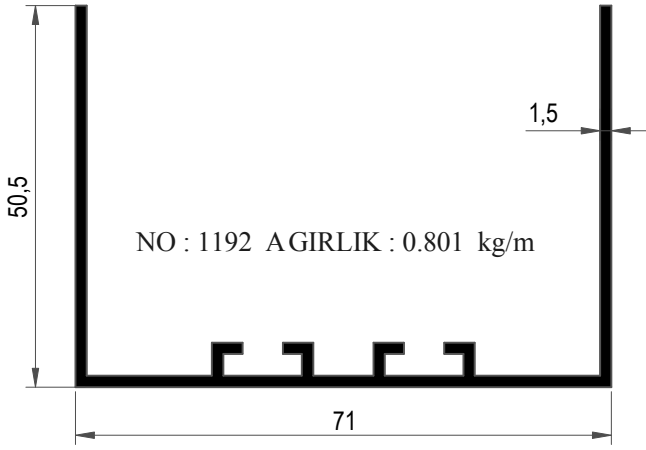

ASANSÖR PROFİLLERİ

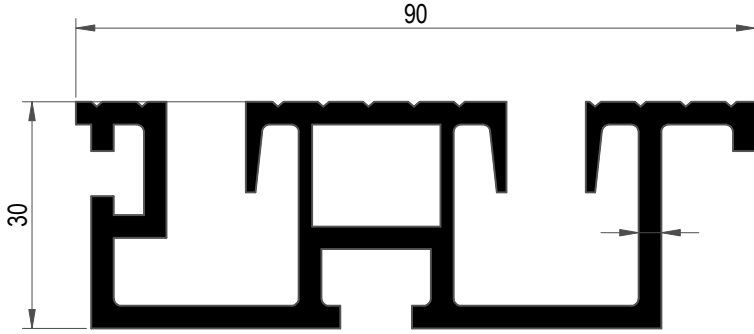

NO : 2132 AGIRLIK : 2,153 kg/m

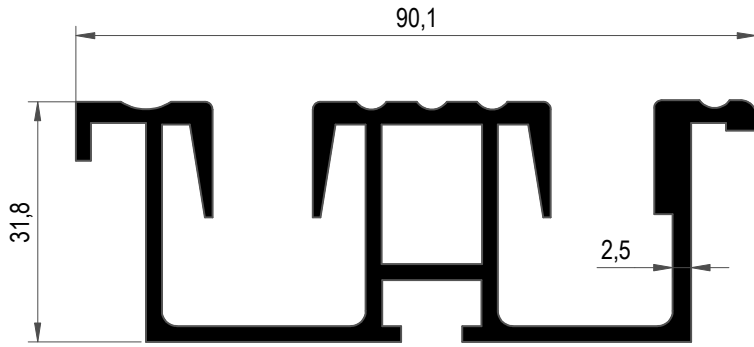

NO : 2293 AGIRLIK : 1,858 kg/m

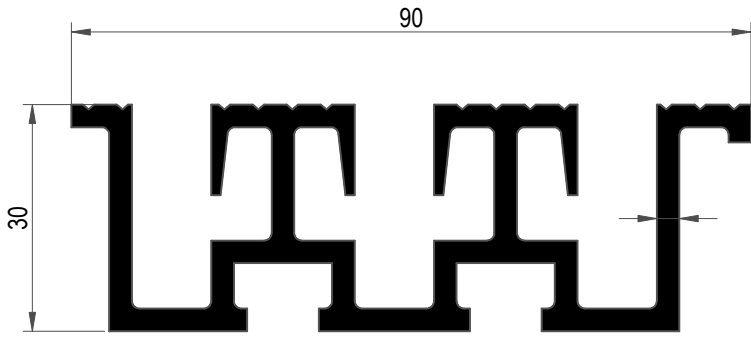

NO : 2133 AGIRLIK : 2,249 kg/m

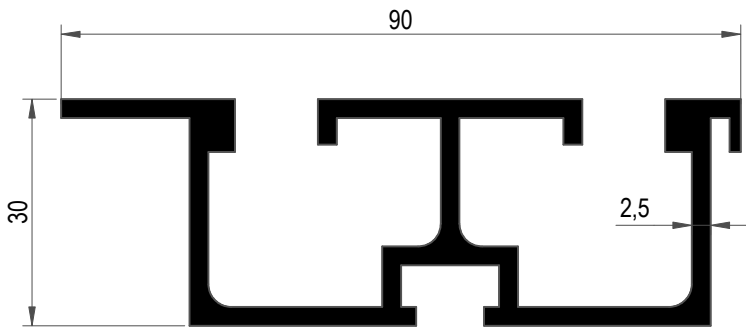

NO : 2246 AGIRLIK : 1,683 kg/m

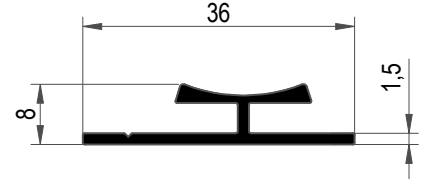

NO : 784 AGIRLIK : 0.235 kg/m

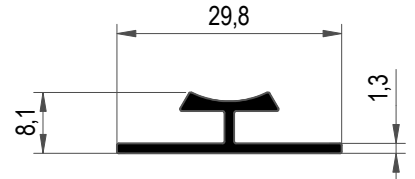

NO : 837 AGIRLIK : 0.177 kg/m

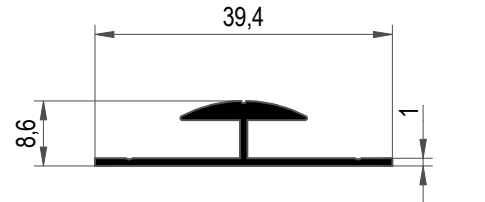

NO : 1494 AGIRLIK : 0.203 kg/m

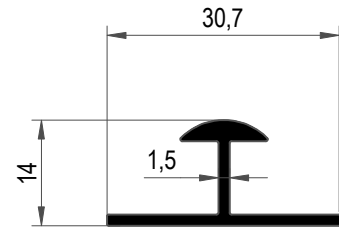

NO : 584 AGIRLIK : 0.227 kg/m

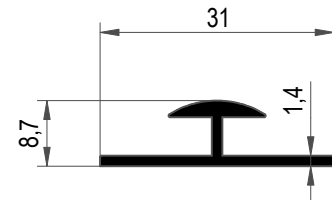

NO : 2030 AGIRLIK : 0.192 kg/m

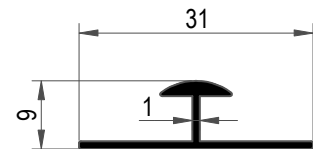

NO : 1001 AGIRLIK : 0.137 kg/m

ASANSÖR PROFİLLERİ

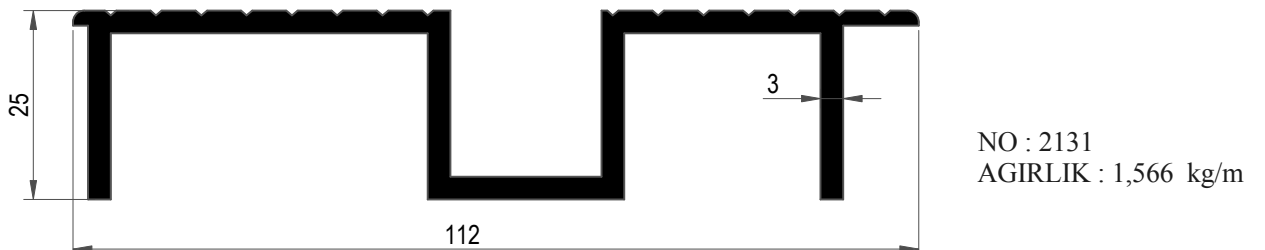
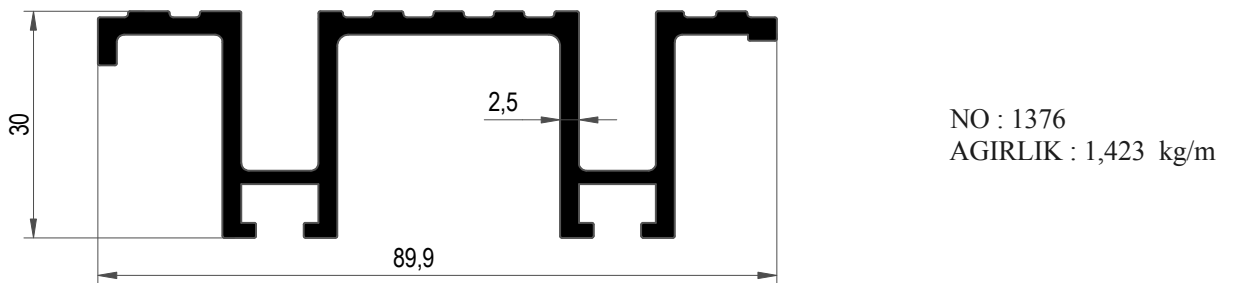
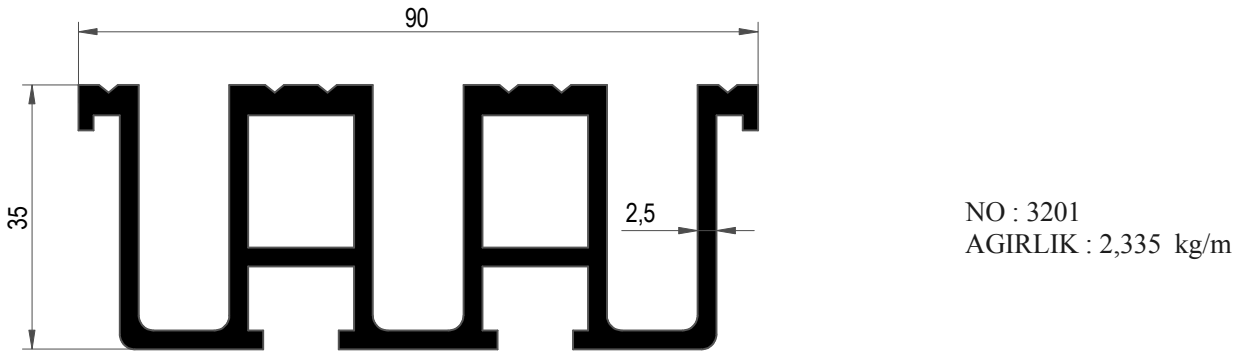
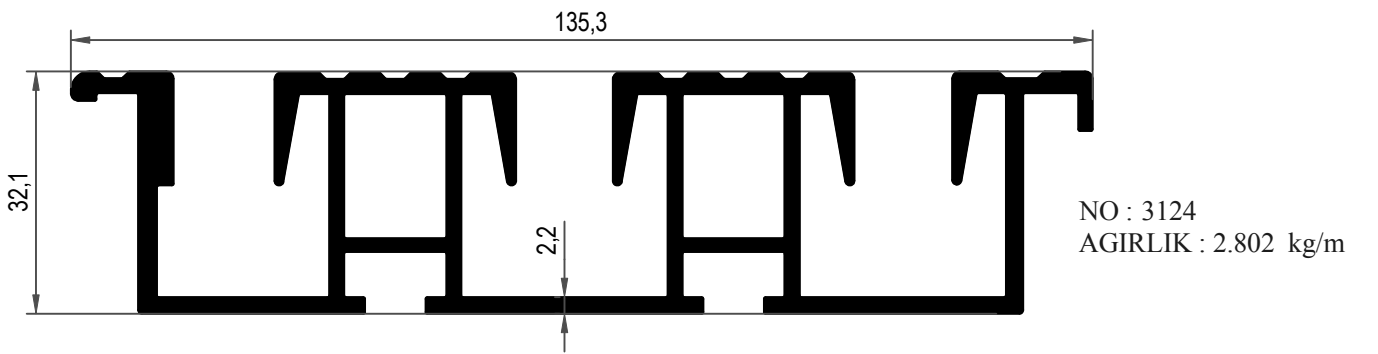
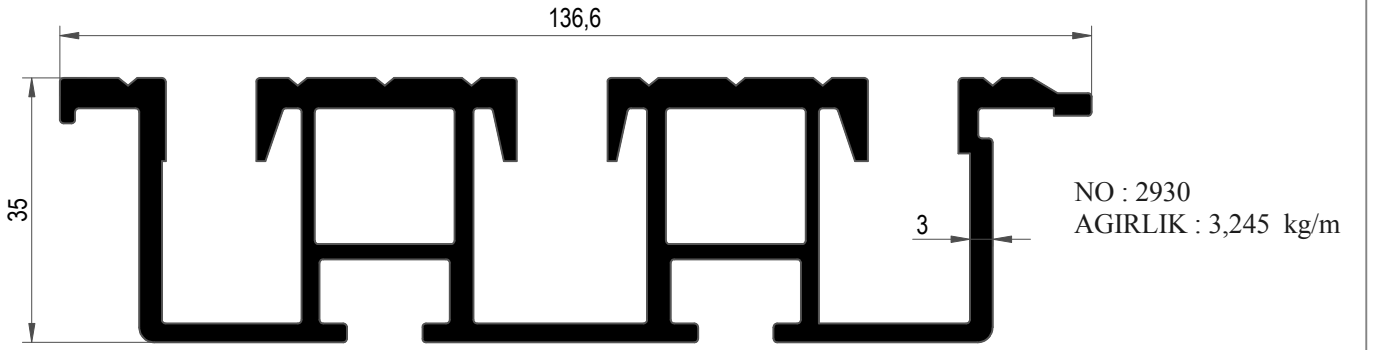

ASANSÖR PROFİLLERİ

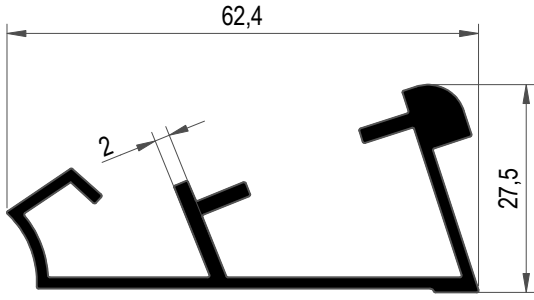

NO : 816 AGIRLIK : 0.704 kg/m

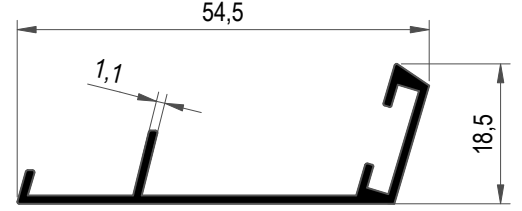

NO : 1225 AGIRLIK : 0.282 kg/m

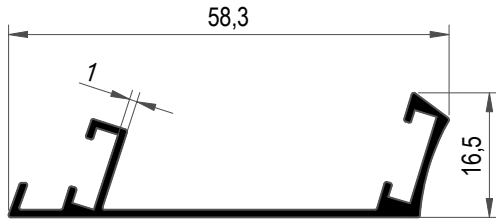

NO : 815 AGIRLIK : 0.302 kg/m

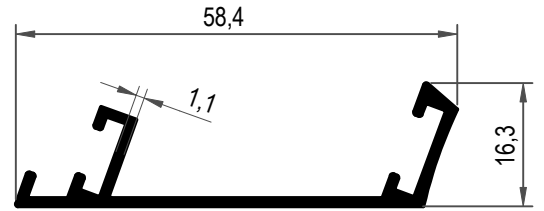

NO : 4394 AGIRLIK : 0.318 kg/m

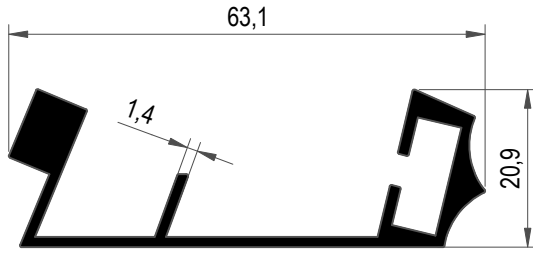

NO : 942 AGIRLIK : 0.700 kg/m

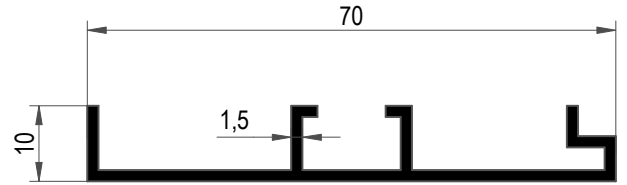

NO : 1490 AGIRLIK : 0.456 kg/m

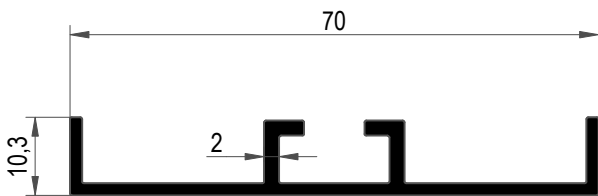

NO : 836 AGIRLIK : 0.501 kg/m

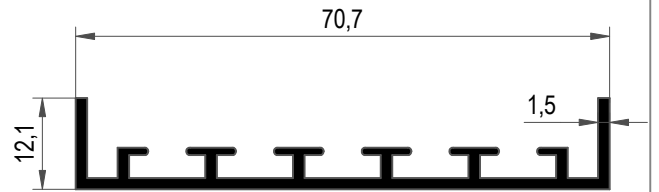

NO : 1378 AGIRLIK : 0.540 kg/m

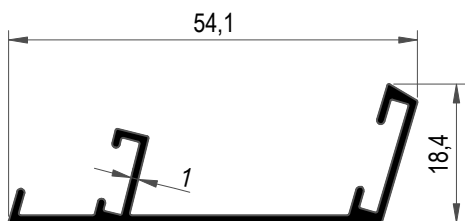

NO : 831 AGIRLIK : 0.275 kg/m

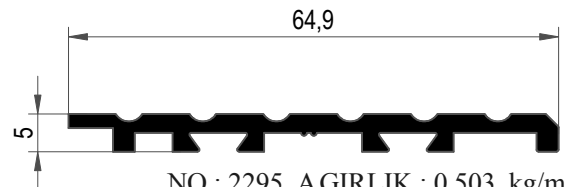

NO : 2295 AGIRLIK : 0.503 kg/m

ASANSÖR PROFİLLERİ

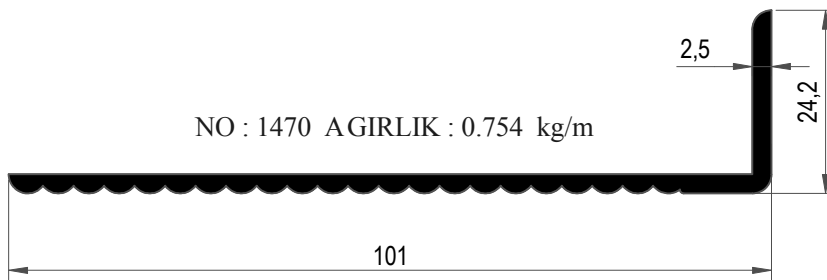
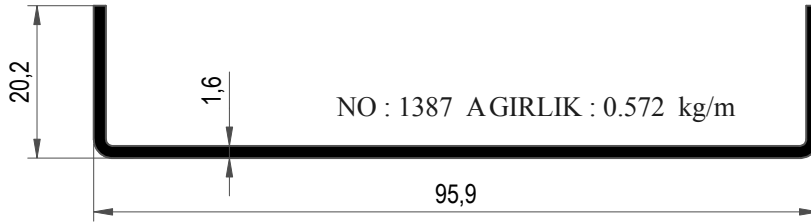
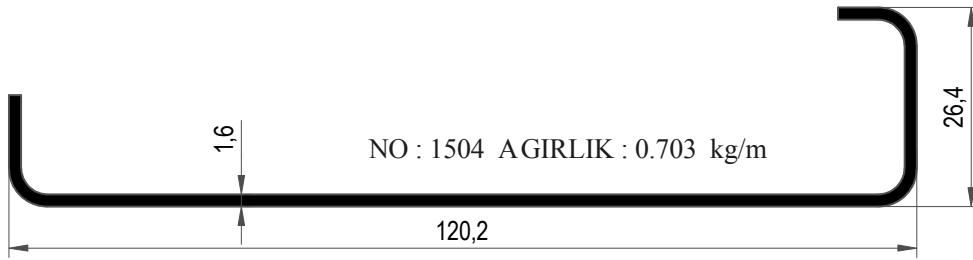
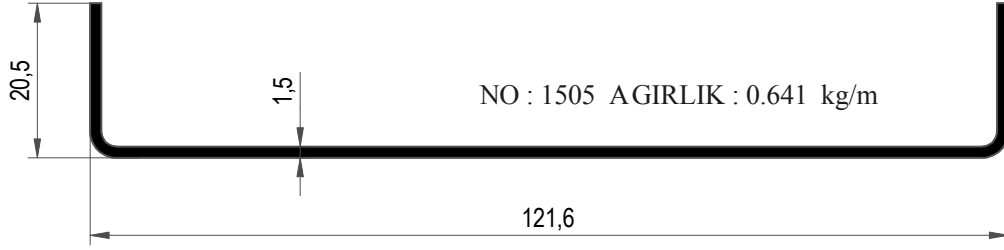

ASANSÖR PROFİLLERİ

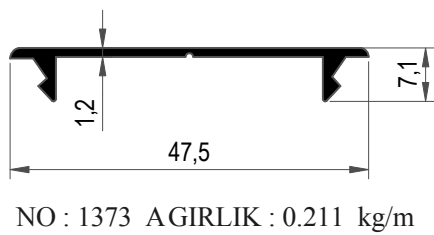
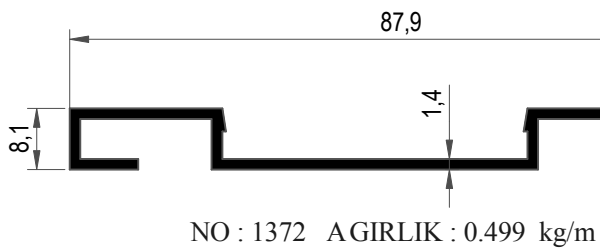
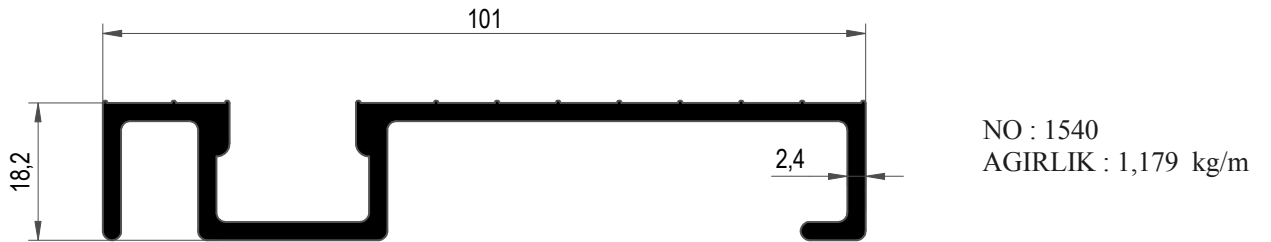
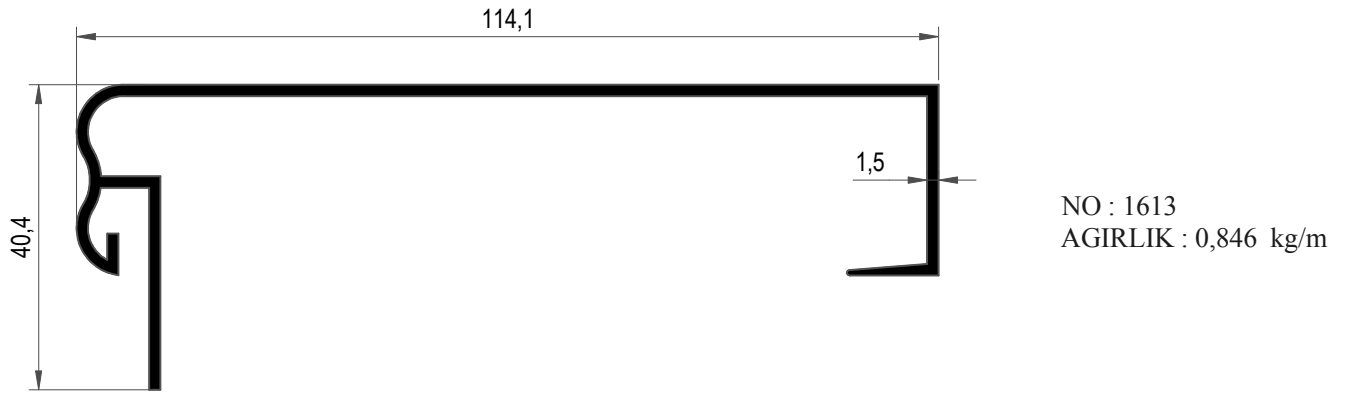
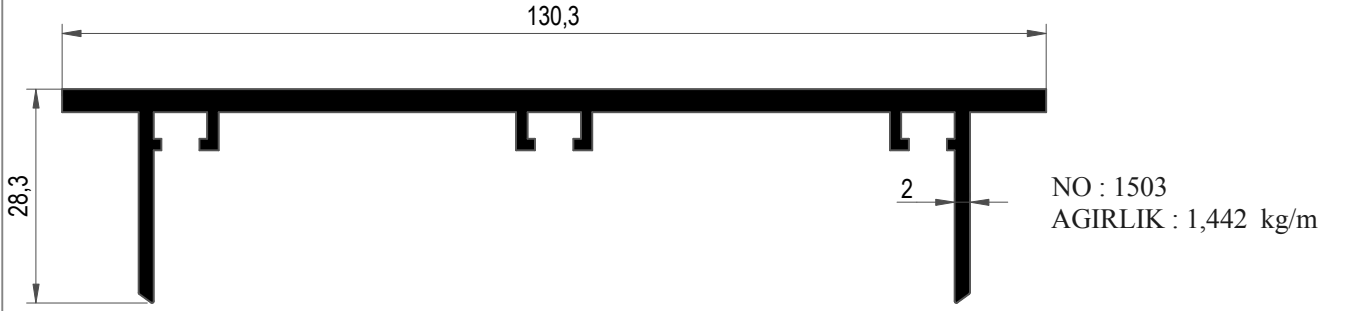

ASANSÖR PROFİLLERİ

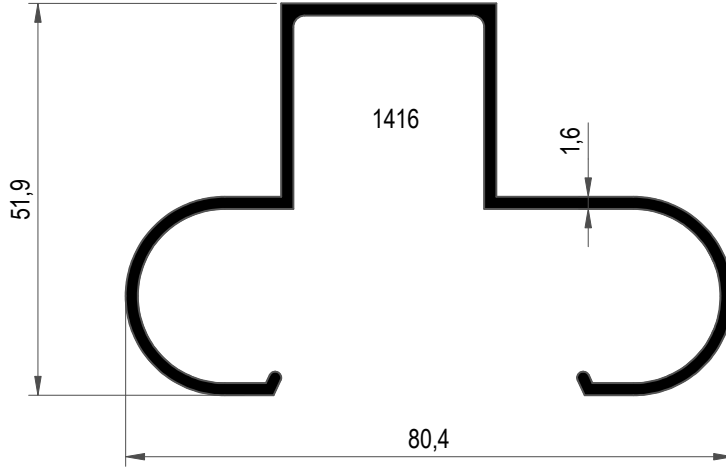

NO : 1416 AGIRLIK : 1,080 kg/m

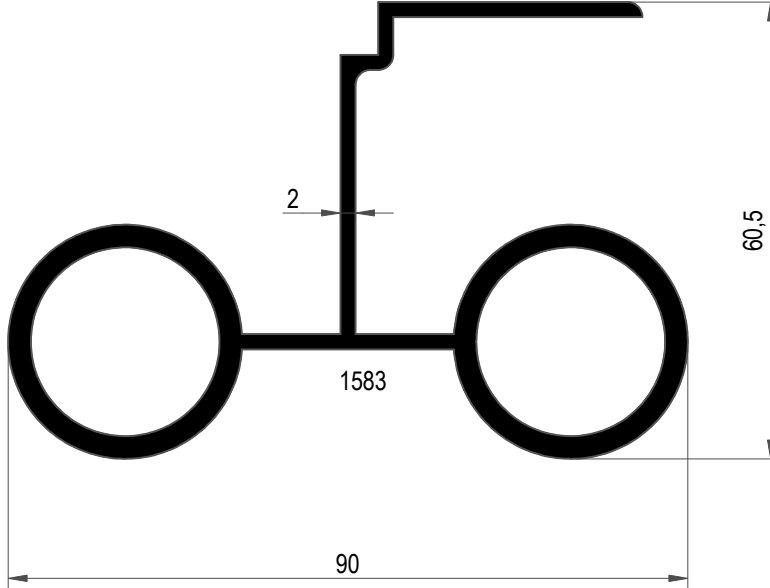

NO : 1583 AGIRLIK : 2,016 kg/m



NO : 1365 AGIRLIK : 0.718 kg/m

ASANSÖR PROFİLLERİ

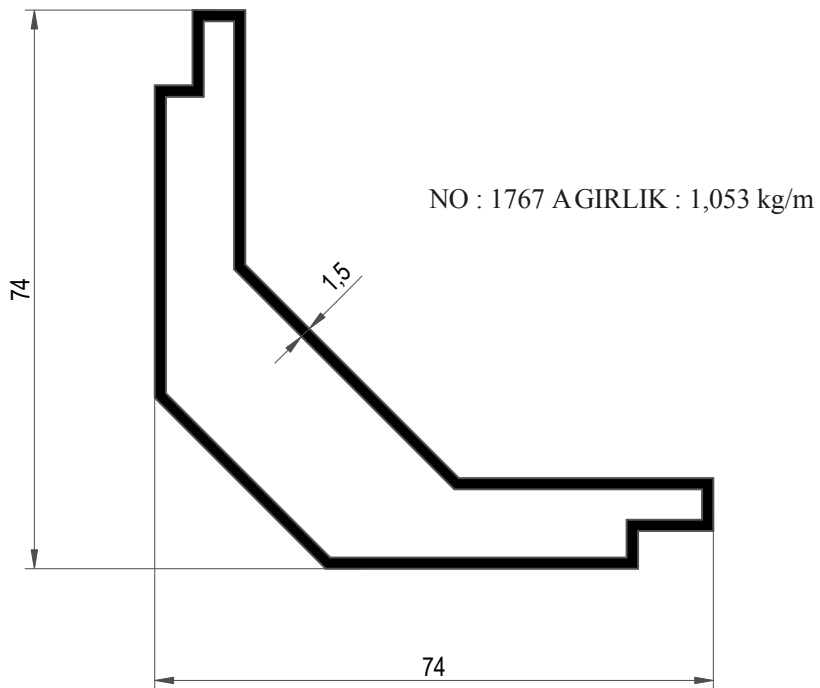
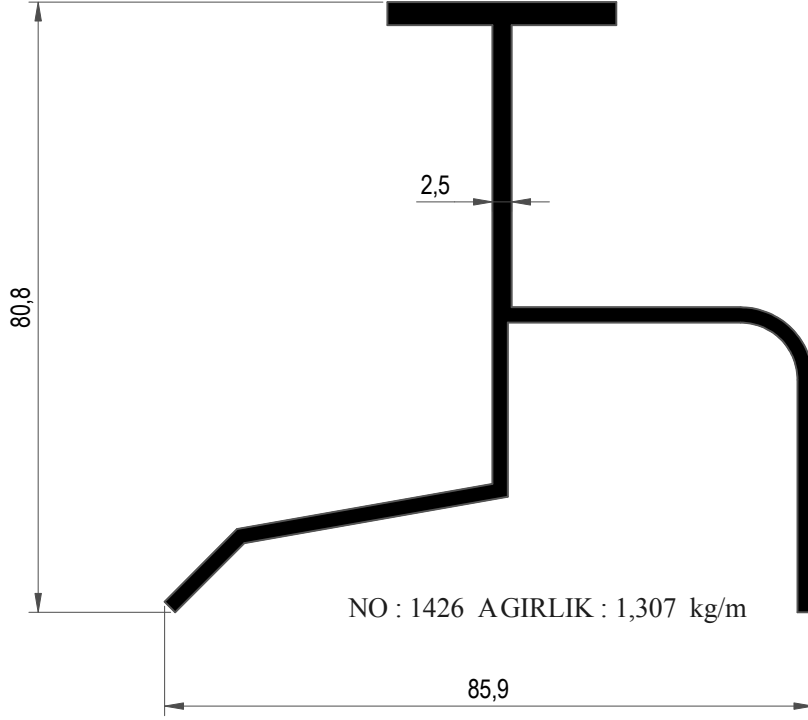

ASANSÖR PROFİLLERİ

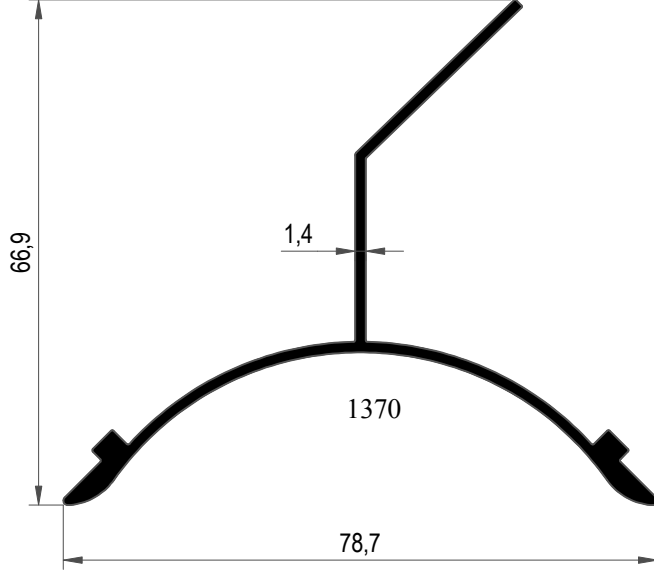

NO : 1370 AGIRLIK : 0.659 kg/m

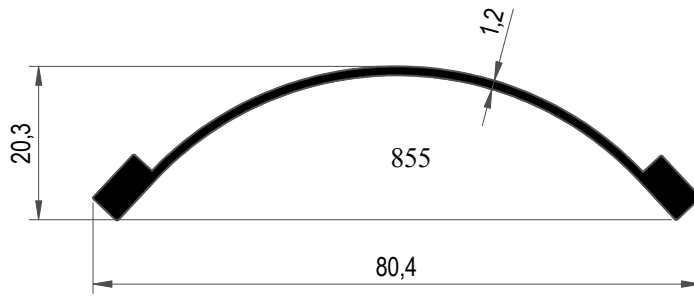

NO : 855
AGIRLIK : 0.422 kg/m

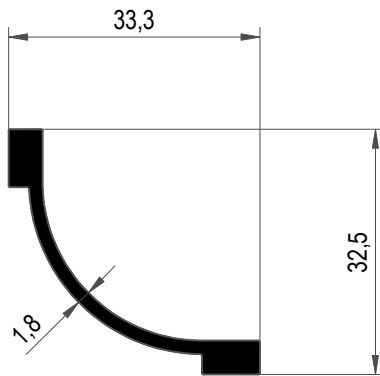

NO : 825 AGIRLIK : 0.350 kg/m