

SERAMİK VE DEKORASYON PROFİLLERİ

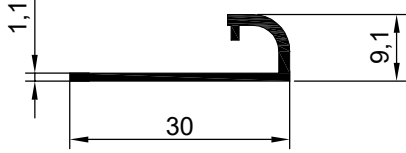

NO : 1928 AGIRLIK : 0.148 kg/m

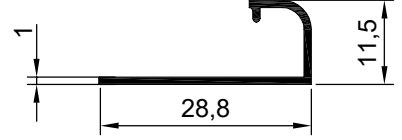

NO : 2378 AGIRLIK : 0.128 kg/m

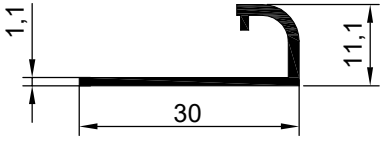

NO : 1927 AGIRLIK : 0.156 kg/m

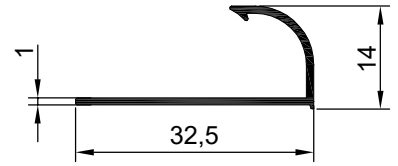

NO : 3315 AGIRLIK : 0.143 kg/m

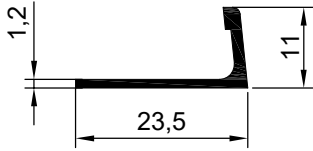

NO : 1929 AGIRLIK : 0.124 kg/m

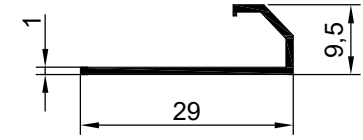

NO : 2387 AGIRLIK : 0.115 kg/m

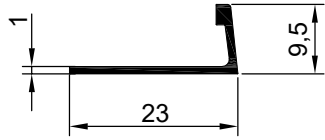

NO : 2425 AGIRLIK : 0.094 kg/m

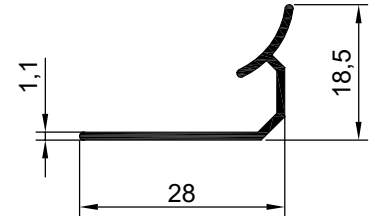

NO : 2287 AGIRLIK : 0.146 kg/m

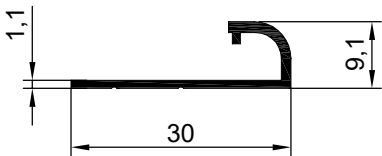

NO : 2199 AGIRLIK : 0.143 kg/m

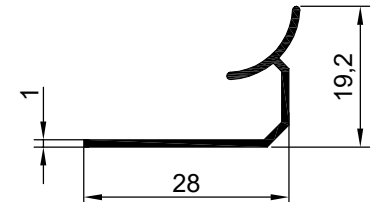

NO : 2389 AGIRLIK : 0.141 kg/m

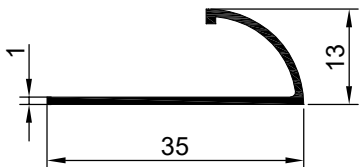

NO : 2201 AGIRLIK : 0.149 kg/m

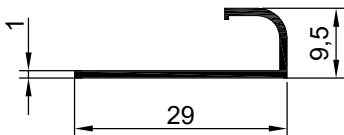

NO : 2377
AGIRLIK : 0.118 kg/m

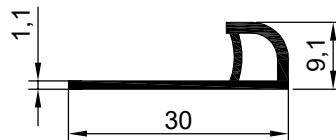

NO : 2286
AGIRLIK : 0.161 kg/m

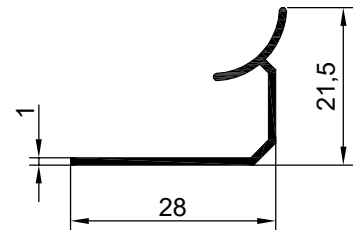

NO : 2472
AGIRLIK : 0.148 kg/m

SERAMİK VE DEKORASYON PROFİLLERİ

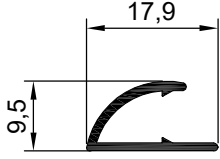

NO : 2276
AGIRLIK : 0.110 kg/m

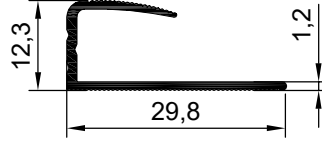

NO : 1429
AGIRLIK : 0.168 kg/m

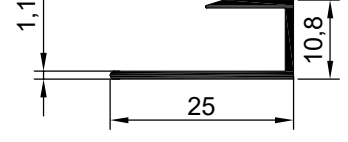

NO : 2226
AGIRLIK : 0.132 kg/m

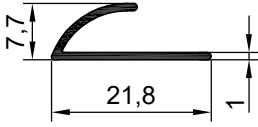

NO : 4885
AGIRLIK : 0.095 kg/m

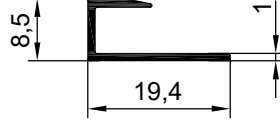

NO : 923
AGIRLIK : 0.093 kg/m

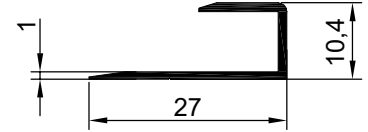

NO : 2421
AGIRLIK : 0.130 kg/m

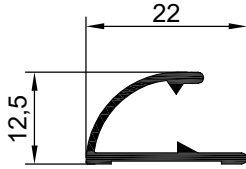

NO : 2390
AGIRLIK : 0.144 kg/m

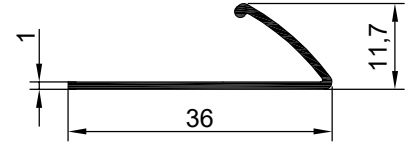

NO : 2422
AGIRLIK : 0.144 kg/m

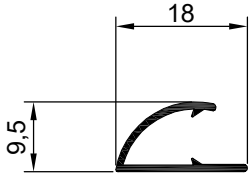

NO : 3310
AGIRLIK : 0.090 kg/m

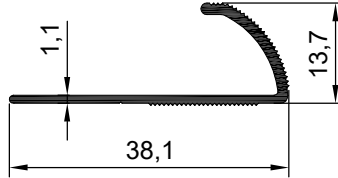

NO : 1873
AGIRLIK : 0.187 kg/m

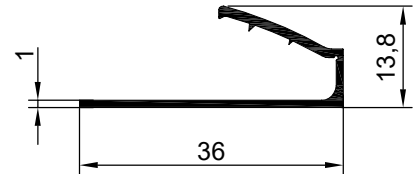

NO : 2388
AGIRLIK : 0.176 kg/m

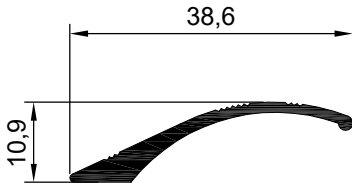

NO : 2436 AGIRLIK : 0.215 kg/m

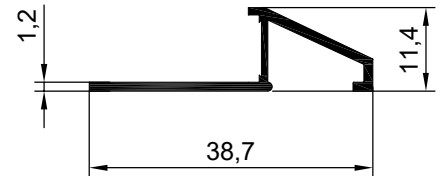

NO : 2381
AGIRLIK : 0.181 kg/m

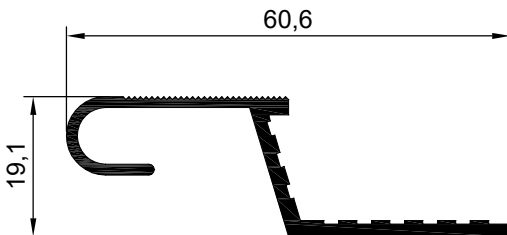

NO : 1924 AGIRLIK : 0.432 kg/m

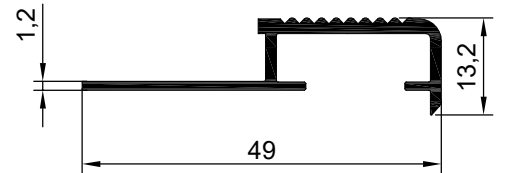

NO : 2382 AGIRLIK : 0.298 kg/m

SERAMİK VE DEKORASYON PROFİLLERİ

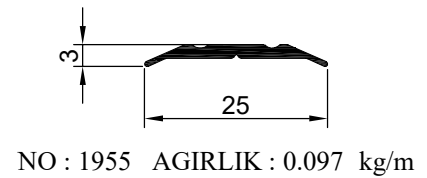
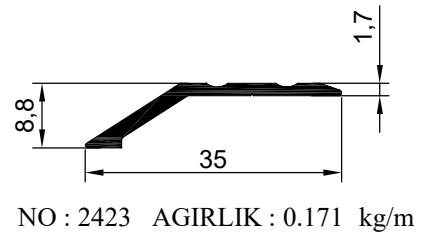
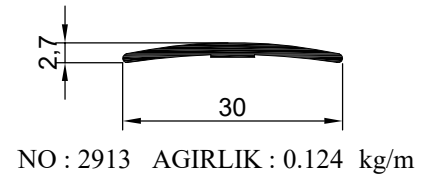
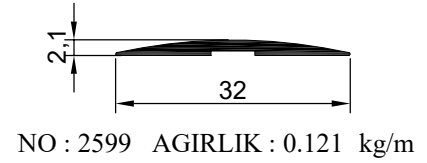
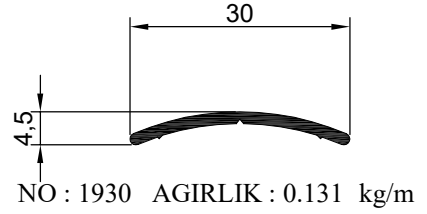
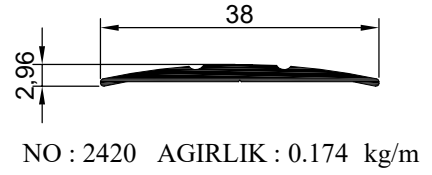
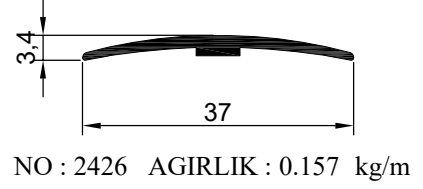
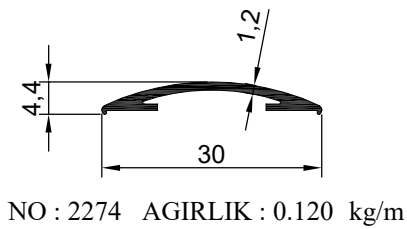
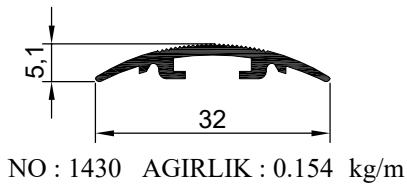
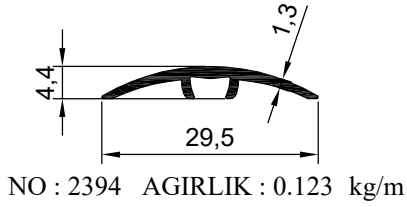
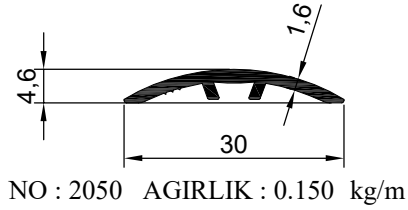
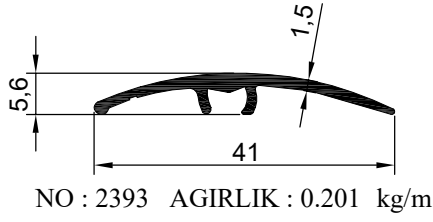
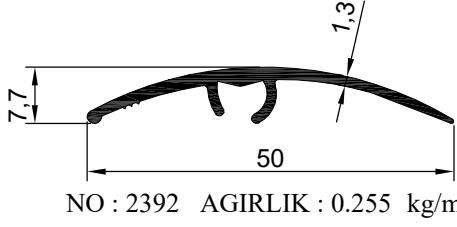

SERAMİK VE DEKORASYON PROFİLLERİ

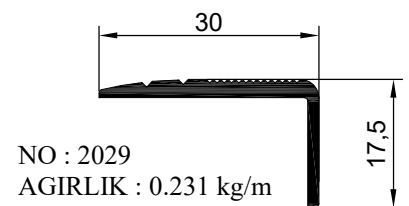
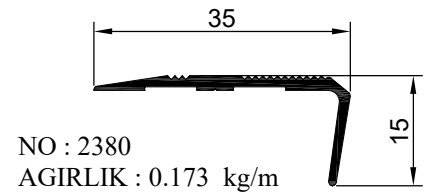
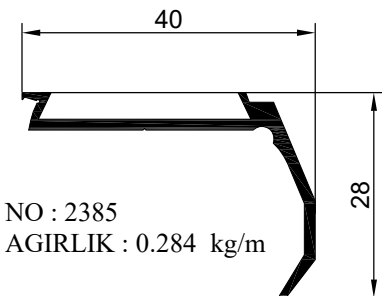
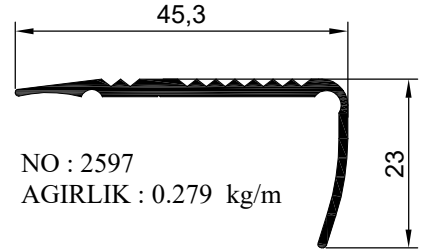
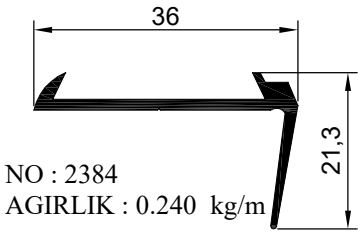
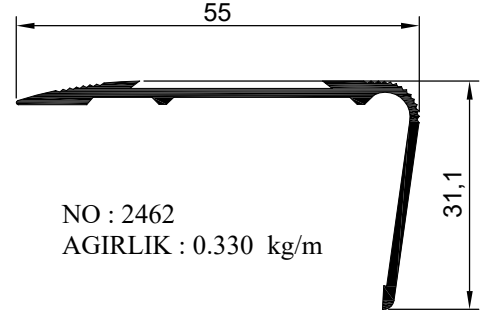
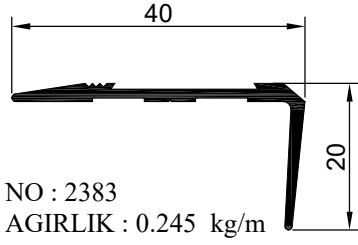
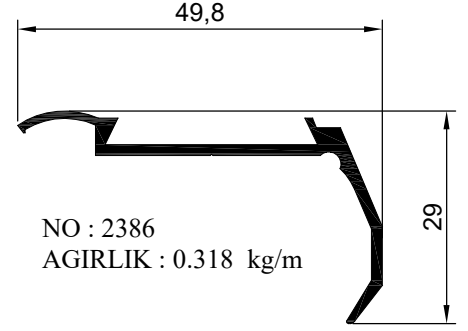
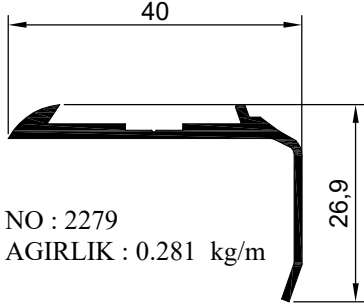

SERAMİK VE DEKORASYON PROFİLLERİ

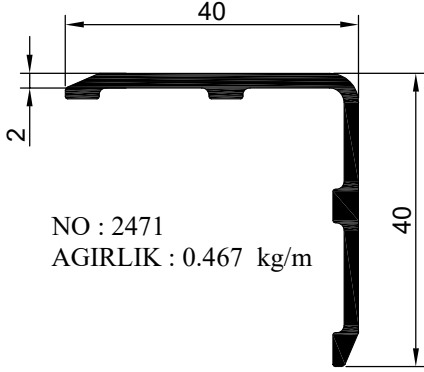

NO : 2471
AGIRLIK : 0.467 kg/m

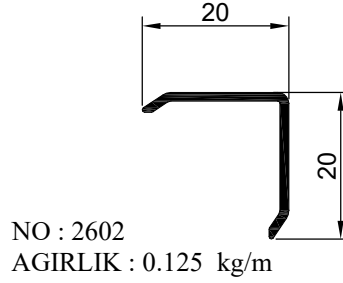

NO : 2602
AGIRLIK : 0.125 kg/m

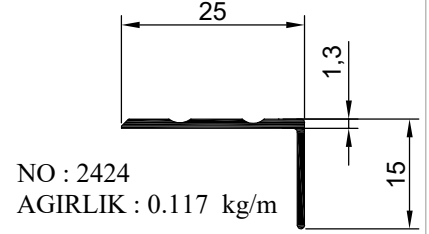

NO : 2424
AGIRLIK : 0.117 kg/m

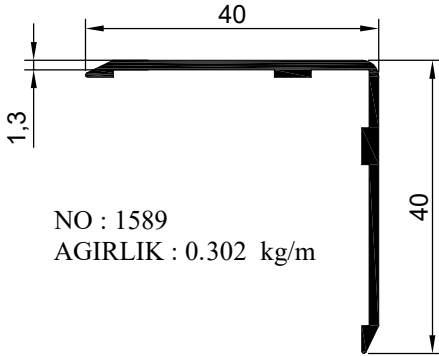

NO : 1589
AGIRLIK : 0.302 kg/m

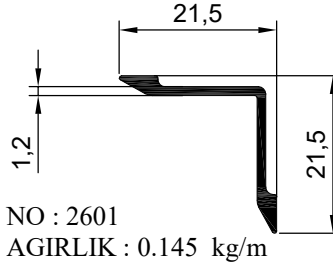

NO : 2601
AGIRLIK : 0.145 kg/m

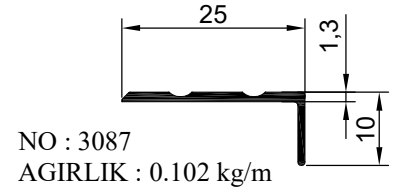

NO : 3087
AGIRLIK : 0.102 kg/m

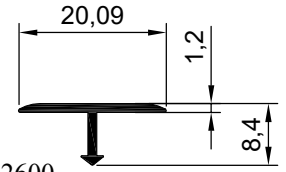

NO : 2600
AGIRLIK : 0.086 kg/m

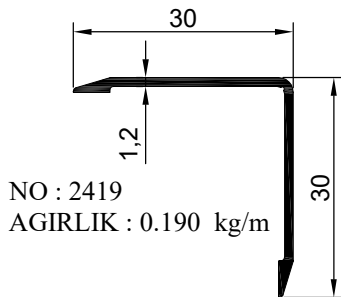

NO : 2419
AGIRLIK : 0.190 kg/m

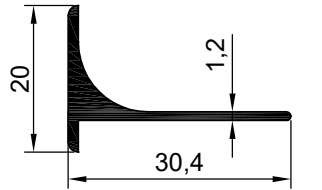

NO : 1953
AGIRLIK : 0.219 kg/m

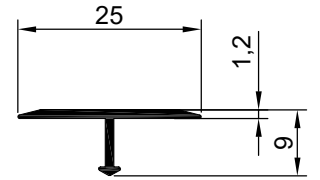

NO : 1994
AGIRLIK : 0.102 kg/m

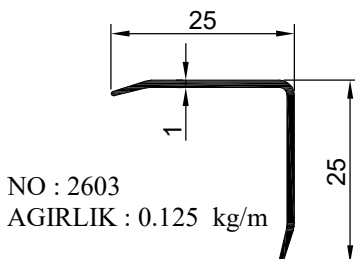

NO : 2603
AGIRLIK : 0.125 kg/m

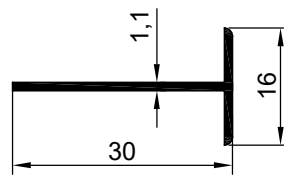

NO : 2165
AGIRLIK : 0.132 kg/m

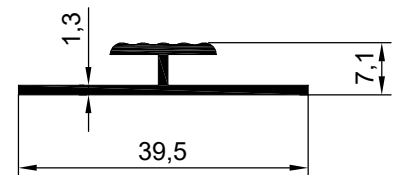

NO : 1215 AGIRLIK : 0.192 kg/m

SERAMİK VE DEKORASYON PROFİLLERİ

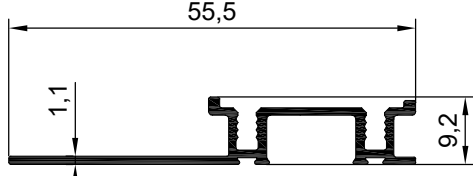

NO : 2461 AGIRLIK : 0.275 kg/m

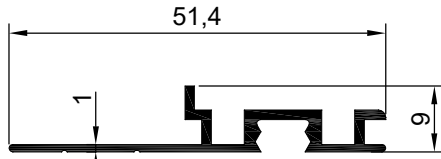

NO : 2200 AGIRLIK : 0.253 kg/m

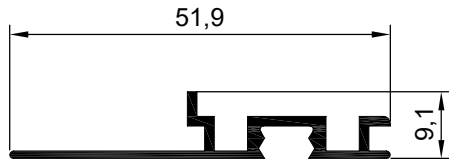

NO : 1926 AGIRLIK : 0.258 kg/m

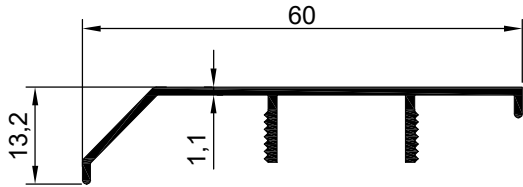

NO : 2391 AGIRLIK : 0.278 kg/m

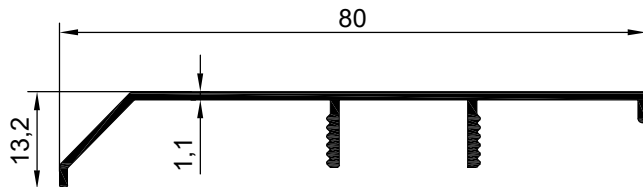

NO : 2372 AGIRLIK : 0.339 kg/m

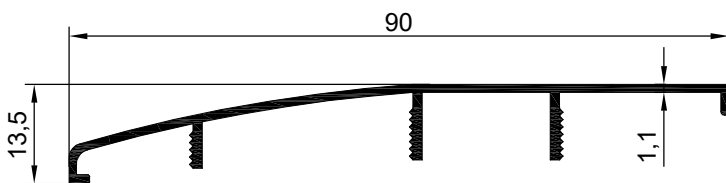

NO : 2371 AGIRLIK : 0.391 kg/m

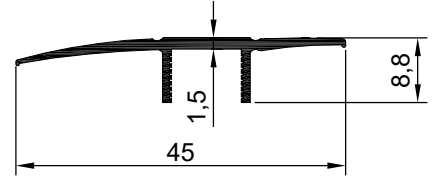

NO : 2373 AGIRLIK : 0.199 kg/m

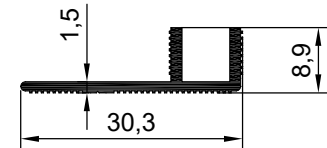

NO : 2374 AGIRLIK : 0.172 kg/m

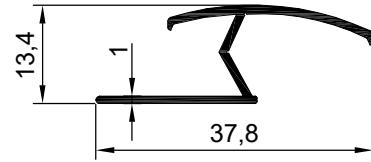

NO : 2379 AGIRLIK : 0.152 kg/m

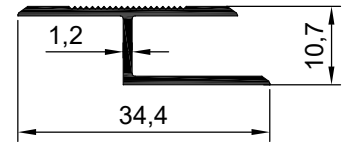

NO : 2039 AGIRLIK : 0.183 kg/m

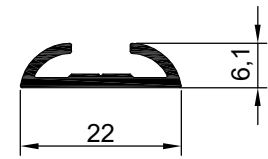

NO : 4261 AGIRLIK : 0.151 kg/m

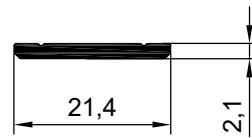

NO : 4260 AGIRLIK : 0.119 kg/m

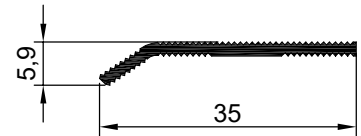

NO : 2598 AGIRLIK : 0.182 kg/m

SERAMİK VE DEKORASYON PROFİLLERİ

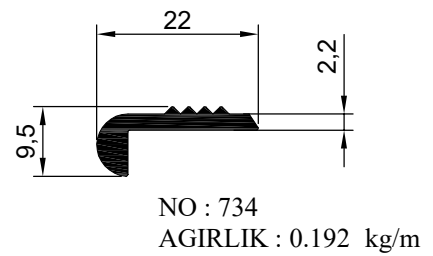
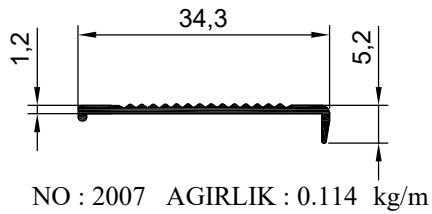
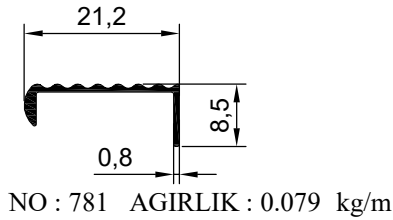
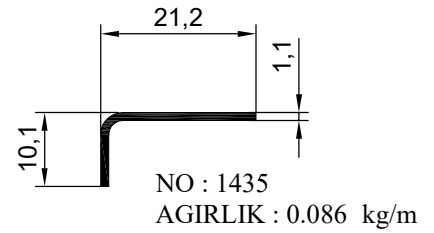
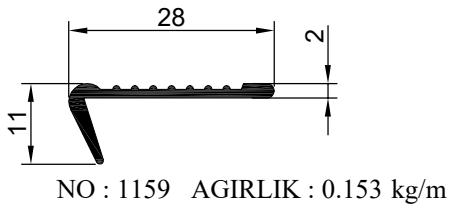
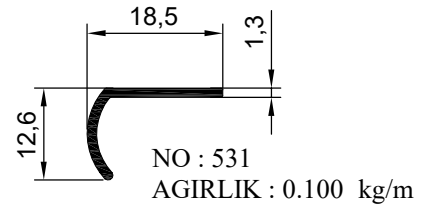
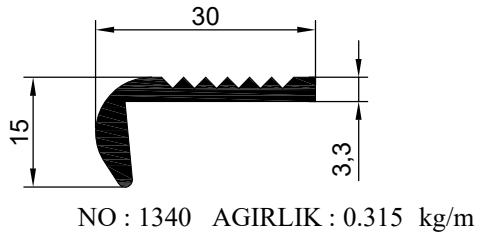
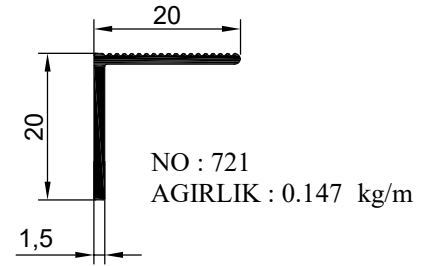
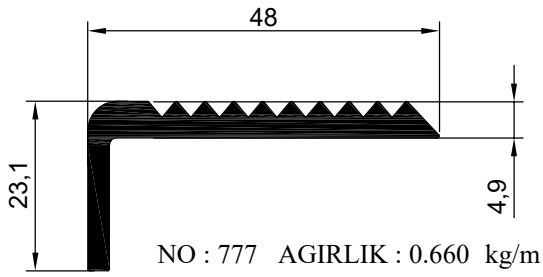
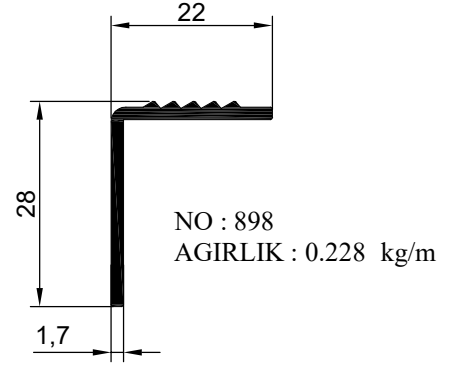
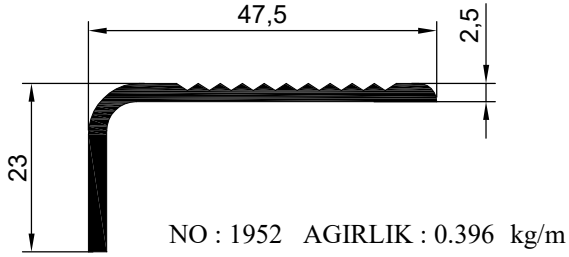

SERAMİK VE DEKORASYON PROFİLLERİ

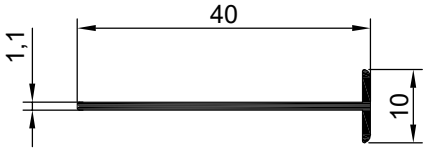

NO : 5639
AGIRLIK : 0.144 kg/m

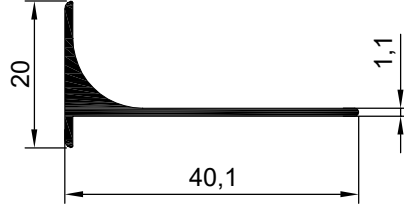

NO : 5640
AGIRLIK : 0.227 kg/m



NO:7292
AGIRLIK: 118 gr/m

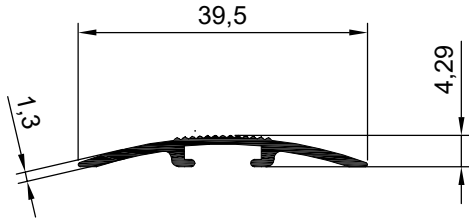

NO : 5478
AGIRLIK : 0.161 kg/m

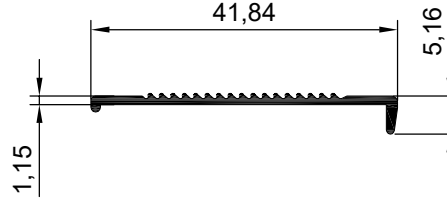

NO : 5641
AGIRLIK : 0.138 kg/m

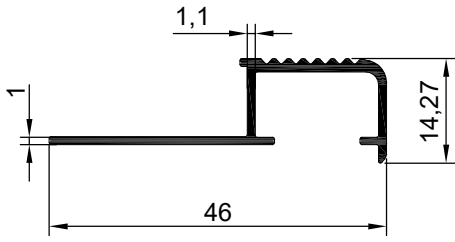

NO : 5769
AGIRLIK : 0.239 kg/m

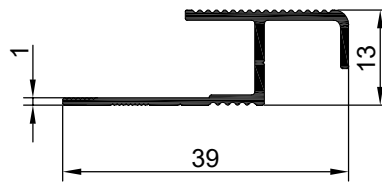

NO : 5645
AGIRLIK : 0.205 kg/m

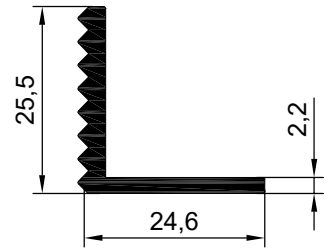

NO : 1160
AĞIRLIK : 0.343 kg/m

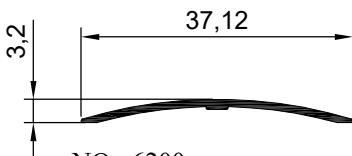

NO : 6200
AĞIRLIK : 103 gr/m

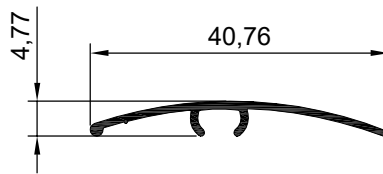

NO : 6201
AĞIRLIK : 132 gr/m

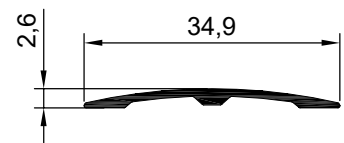

NO : 6199
AĞIRLIK : 115 gr/m

SERAMİK VE DEKORASYON PROFİLLERİ

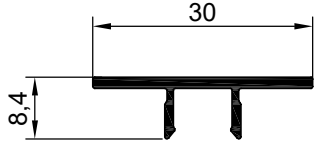

NO : 10391
AGIRLIK : 0.162 kg/m

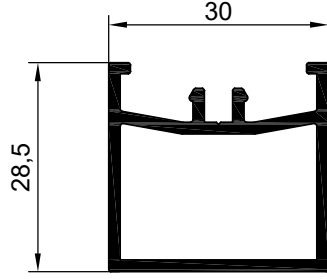

NO : 10392
AGIRLIK : 0.532 kg/m

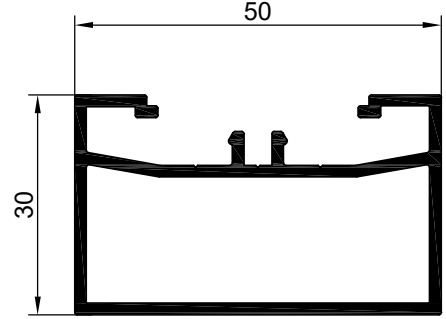

NO : 10393
AGIRLIK : 0.802 kg/m

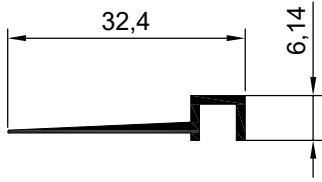

NO : 1911 AGIRLIK : 0.119 kg/m

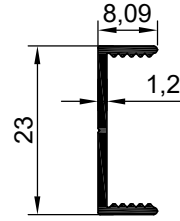

NO : 2368
AGIRLIK : 0.121 kg/m