

MUHTELİF PROFİLLER

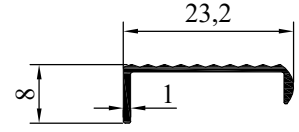

NO : 522
AGIRLIK : 0.080 kg/m

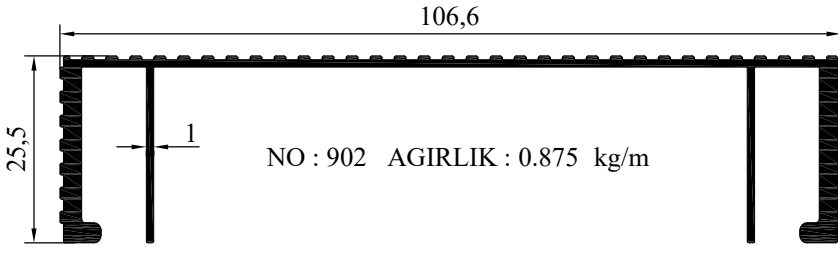
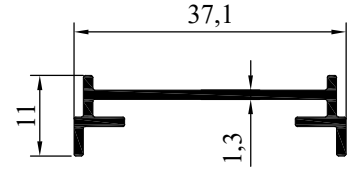
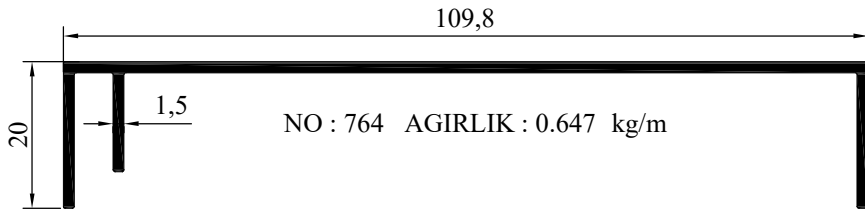

NO : 526
AGIRLIK : 0.227 kg/m

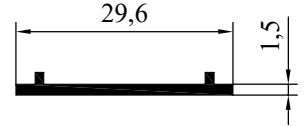
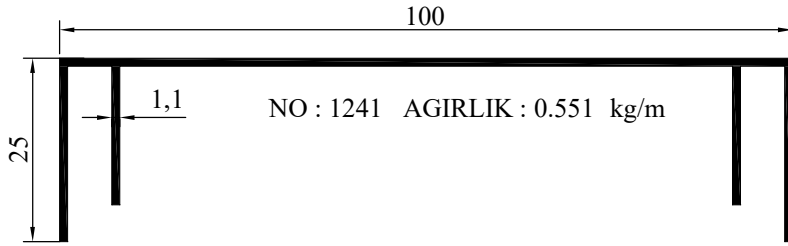

NO : 1961
AGIRLIK : 0.130 kg/m

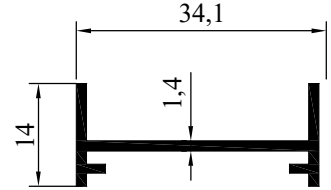
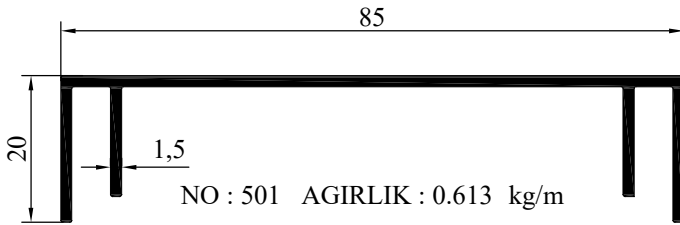

NO : 1960
AGIRLIK : 0.237 kg/m

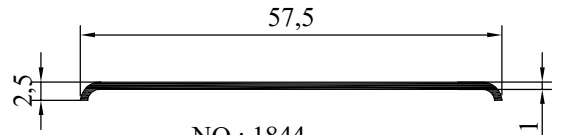
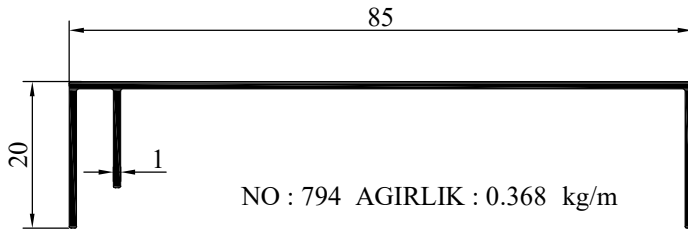

NO : 1844
AGIRLIK : 0.158 kg/m

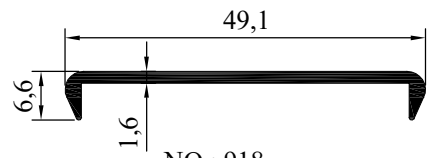
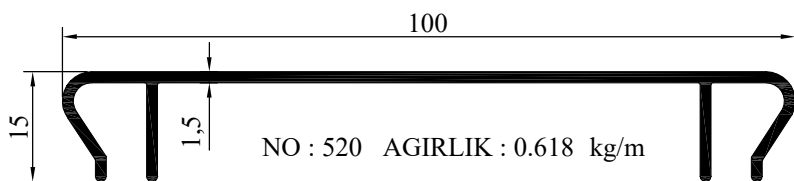

NO : 918
AGIRLIK : 0.248 kg/m

MUHTELİF PROFİLLER

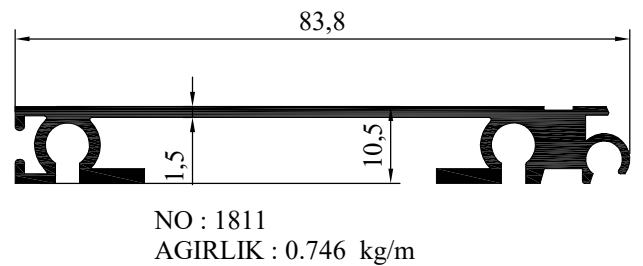
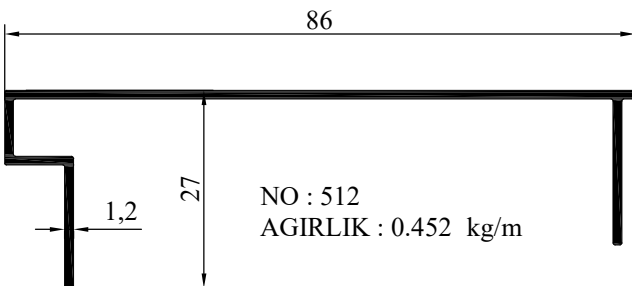
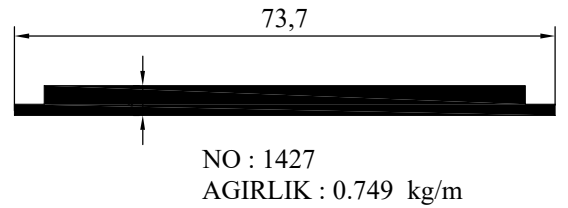
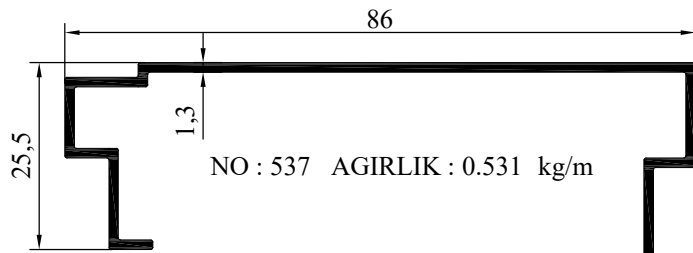
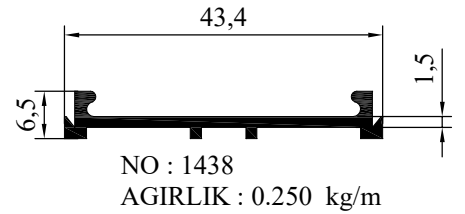
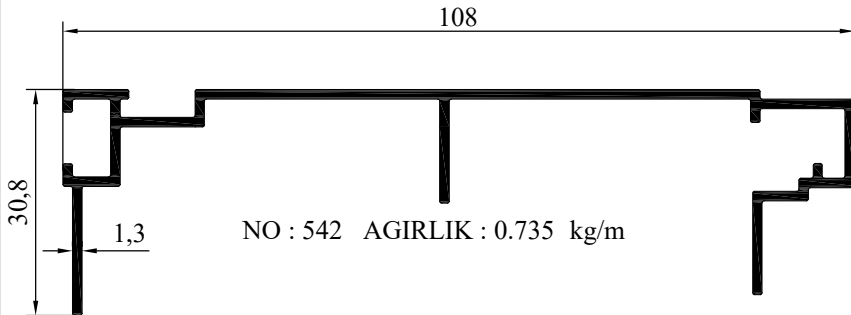
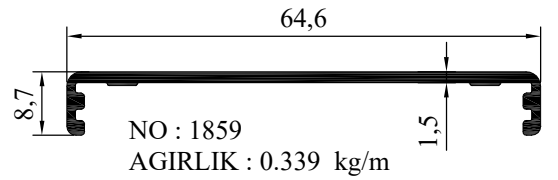
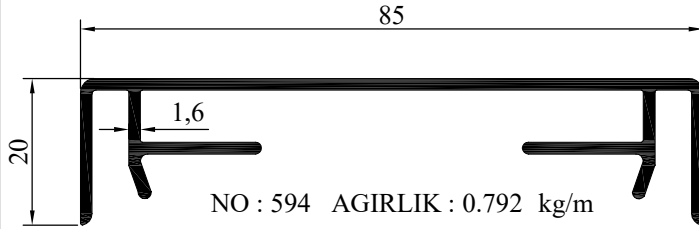
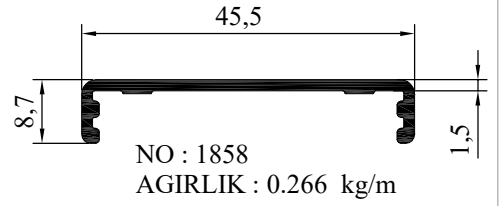
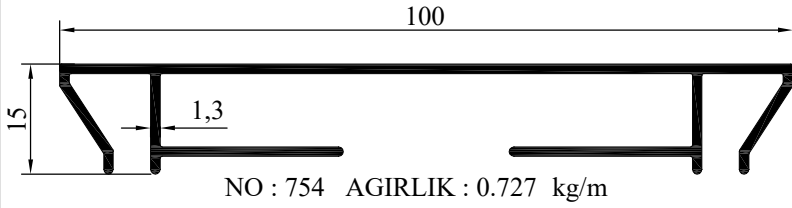
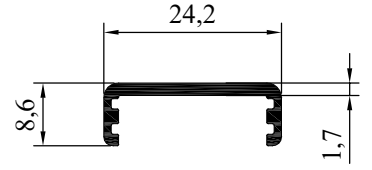
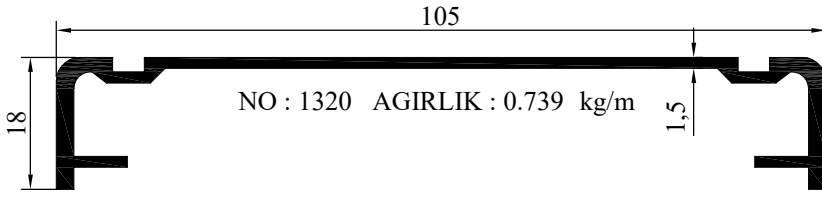

MUHTELİF PROFİLLER

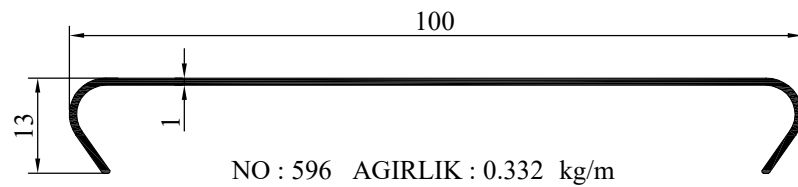
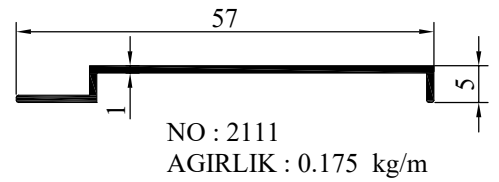
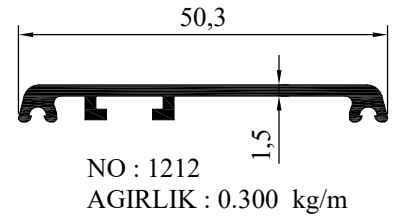
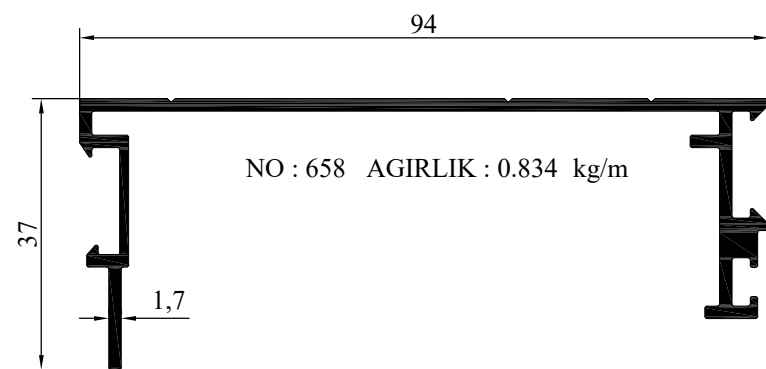
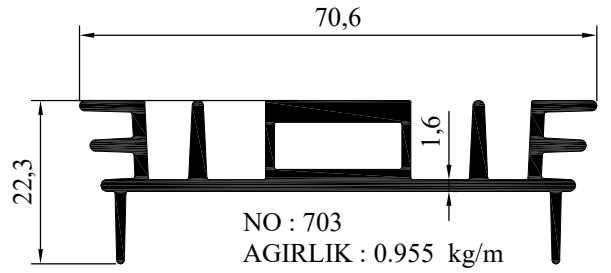
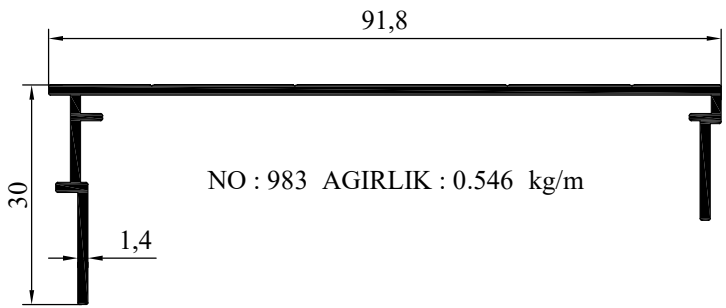
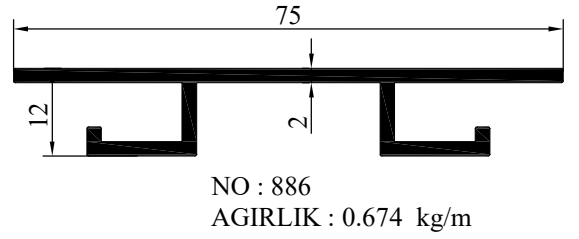
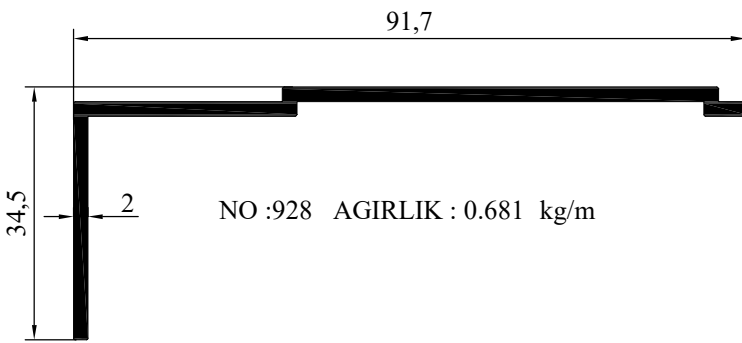
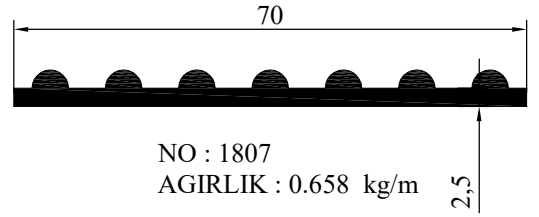
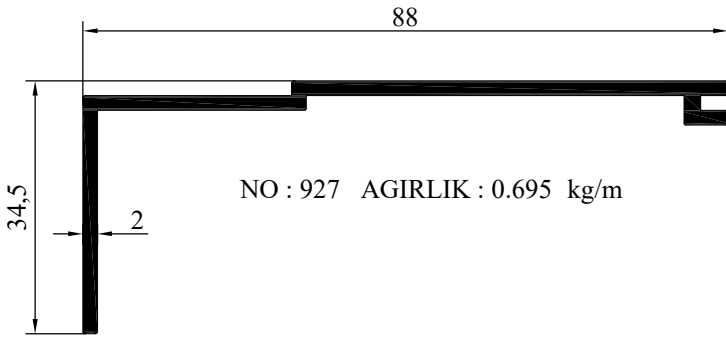

MUHTELİF PROFİLLER

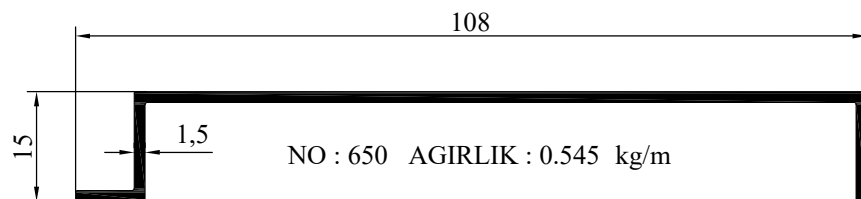
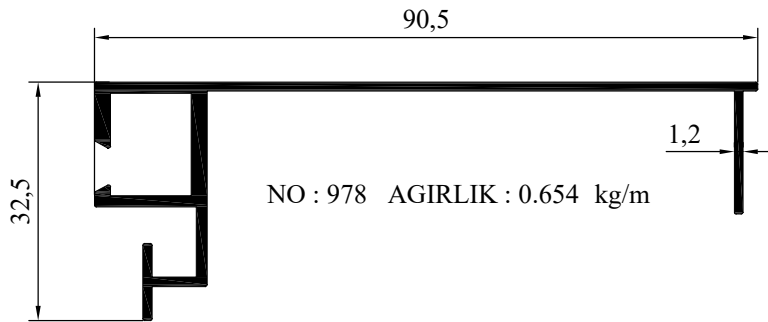
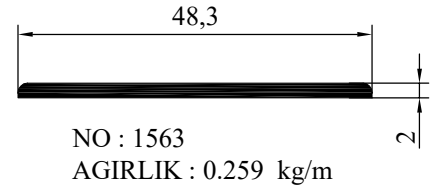
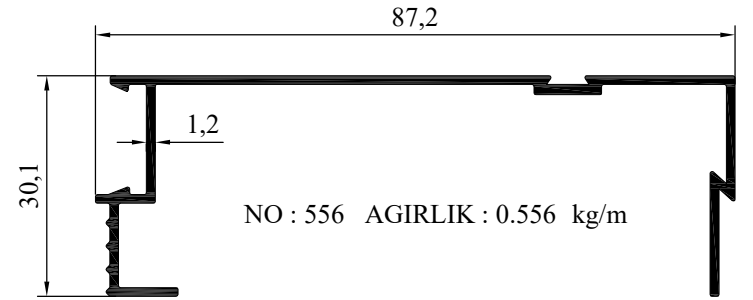
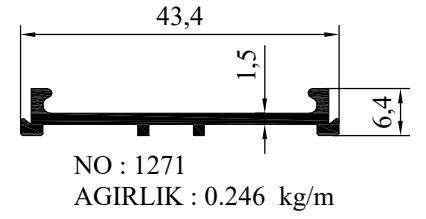
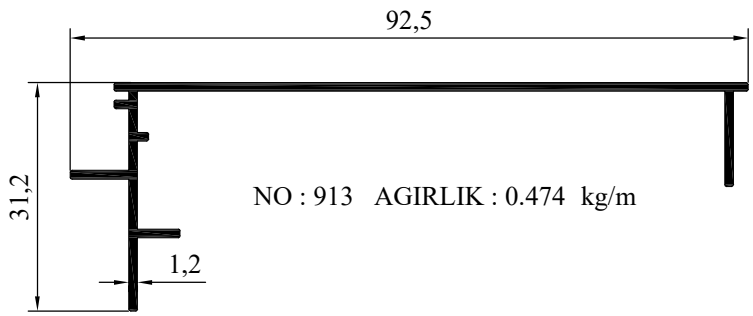
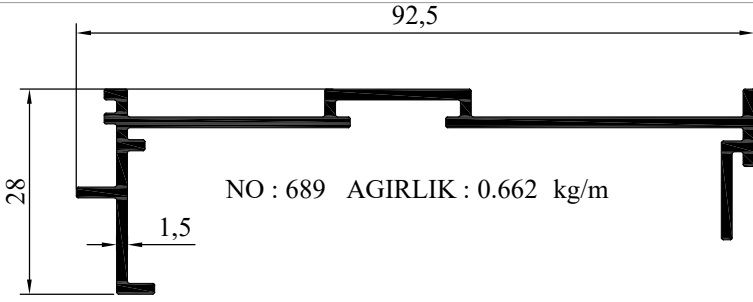

MUHTELİF PROFİLLER

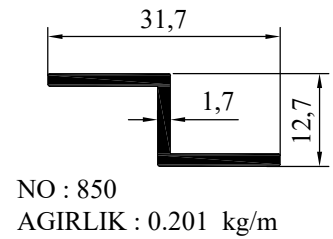
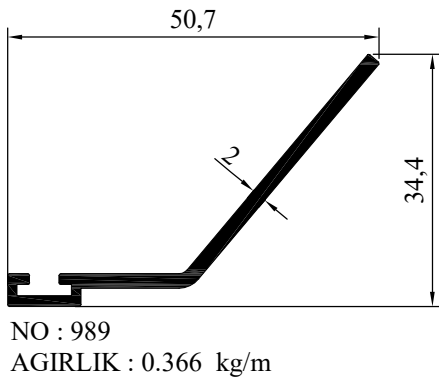
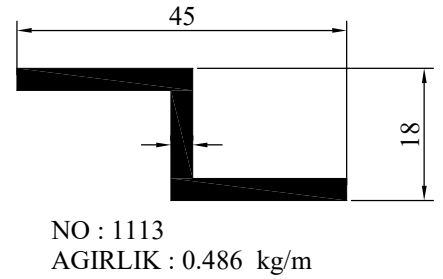
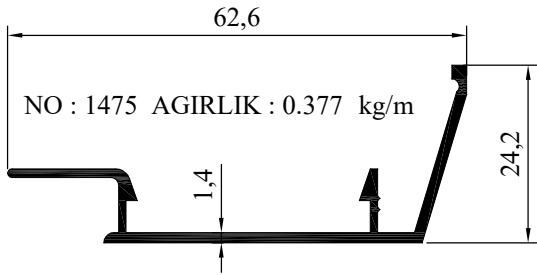
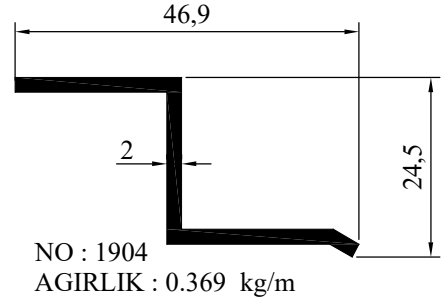
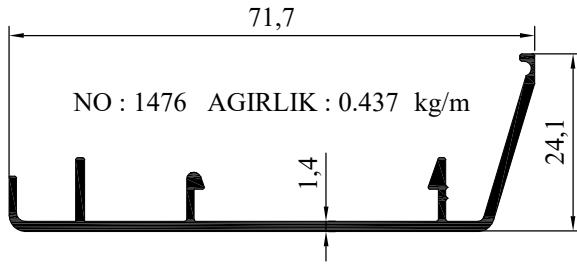
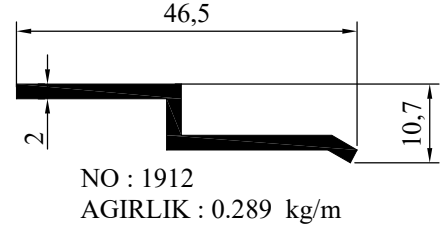
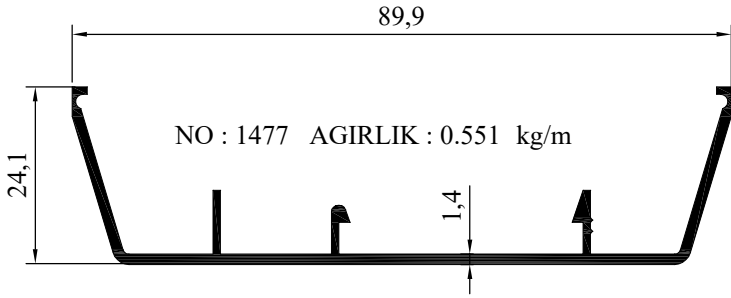
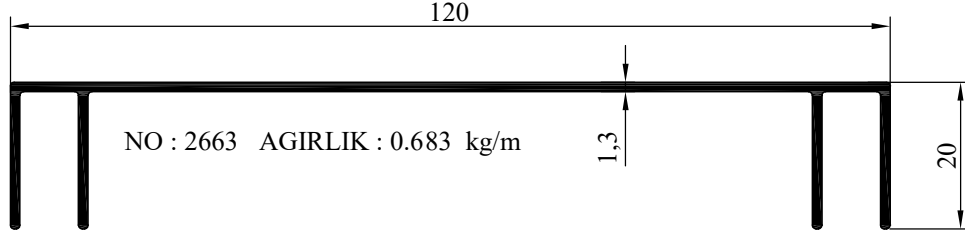
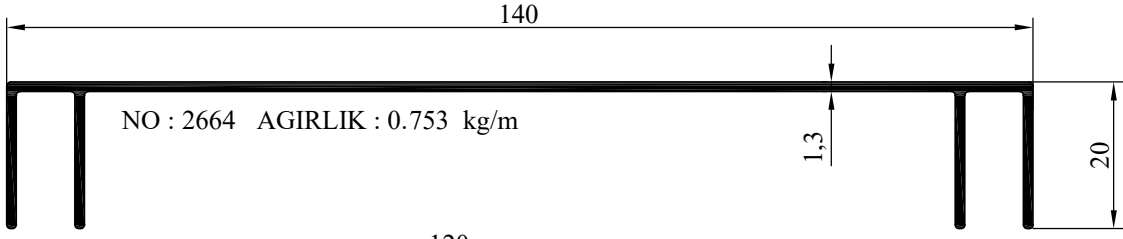

MUHTELİF PROFİLLER

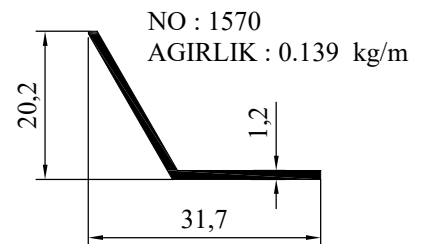
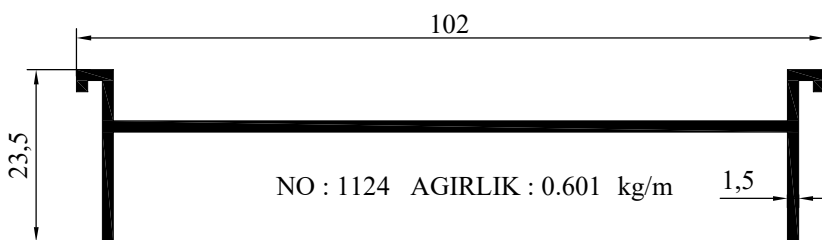
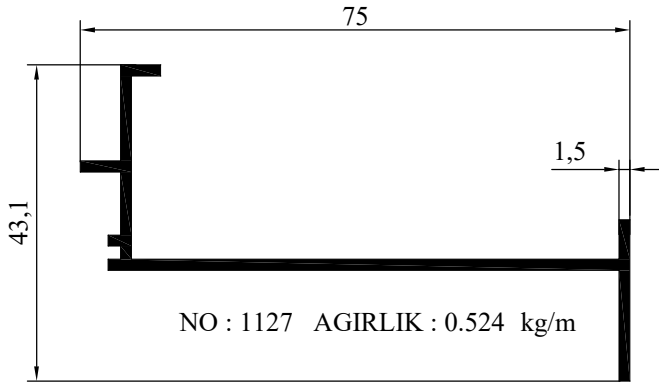
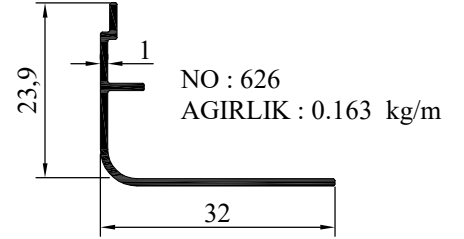
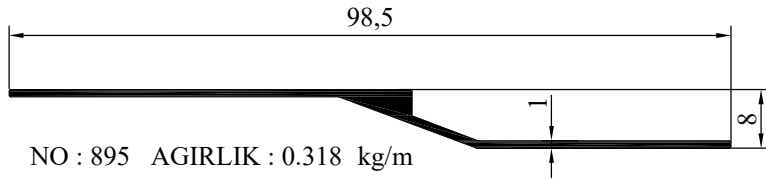
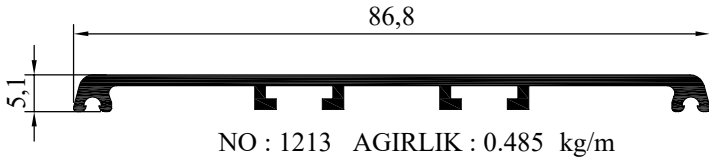
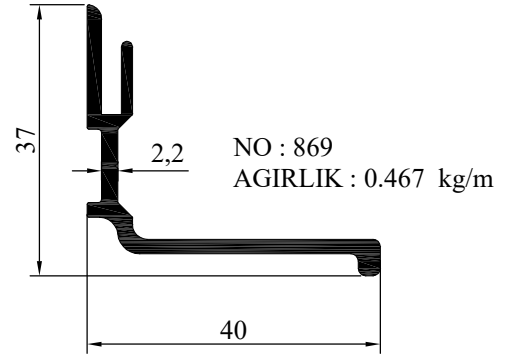
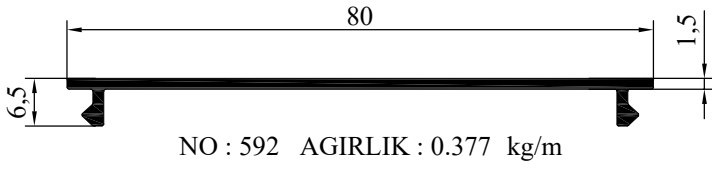
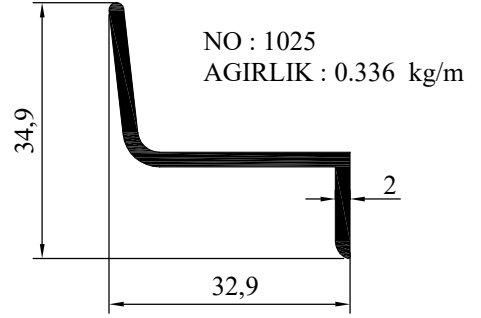
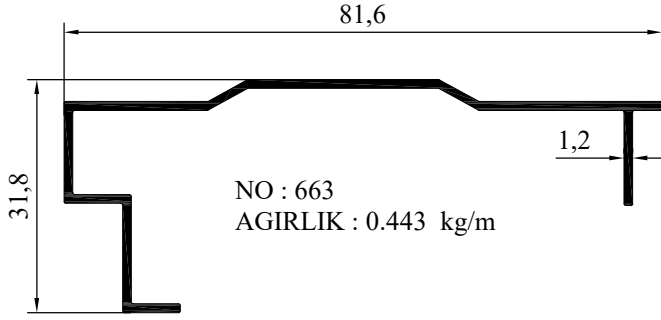

MUHTELİF PROFİLLER

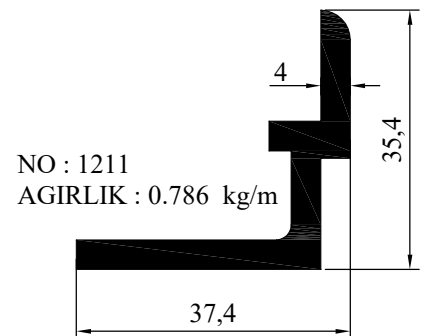
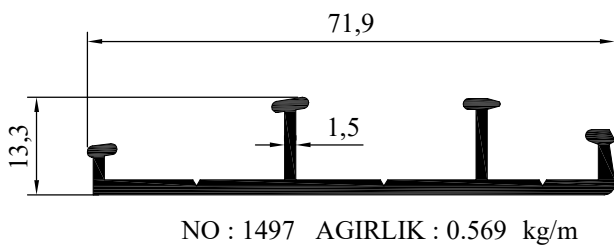
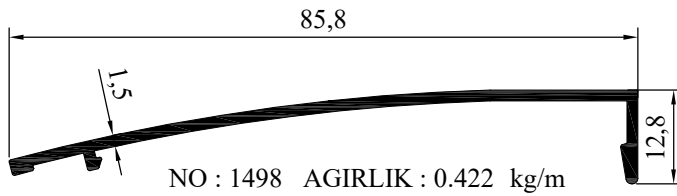
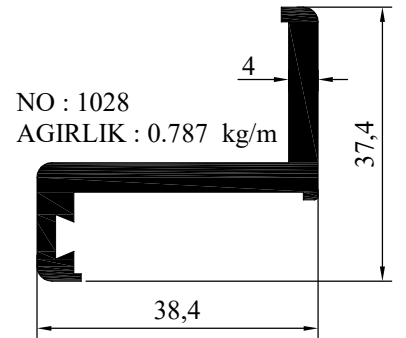
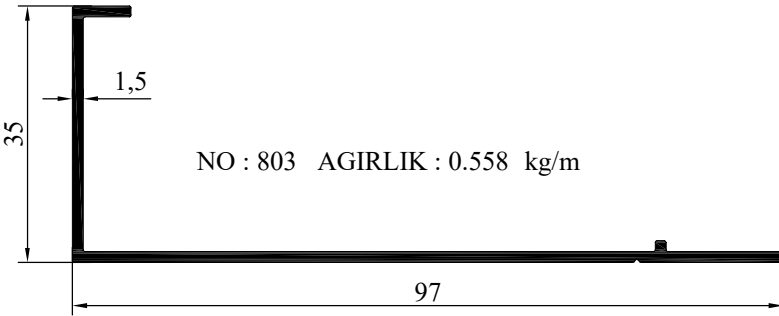
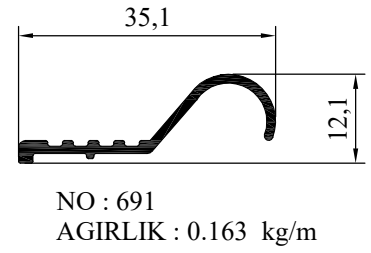
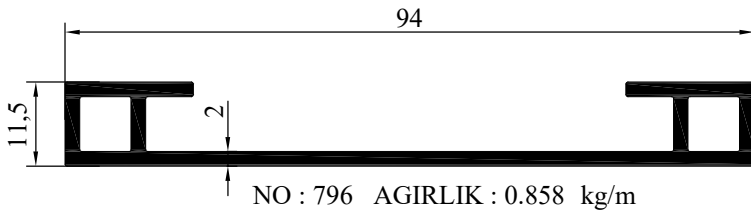
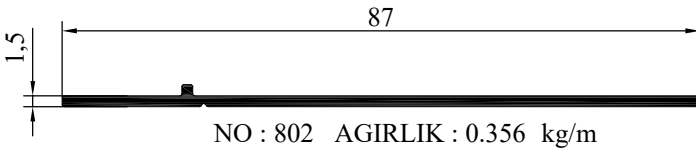
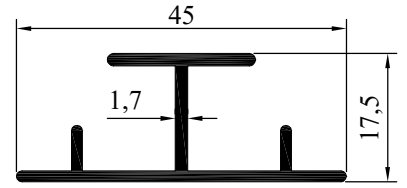
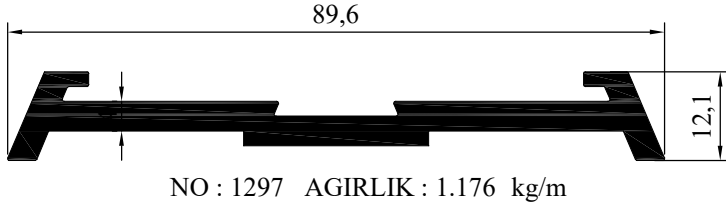
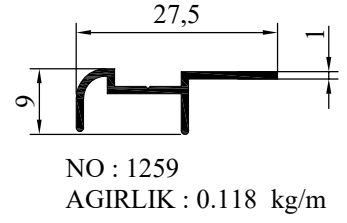
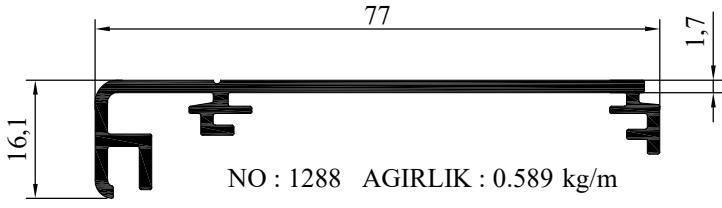

MUHTELİF PROFİLLER

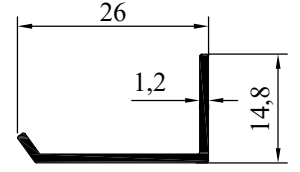
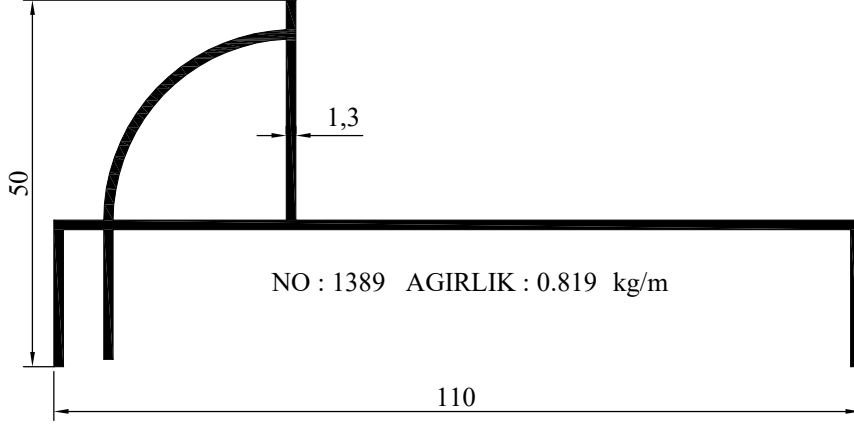

NO : 665
AGIRLIK : 0.132 kg/m

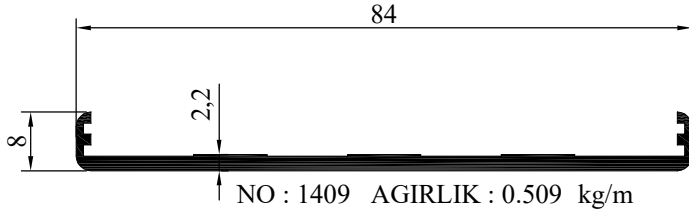

NO : 1409 AGIRLIK : 0.509 kg/m

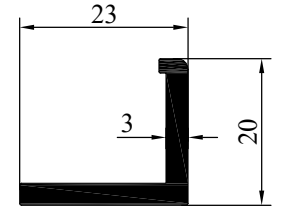

NO : 1005
AGIRLIK : 0.328 kg/m

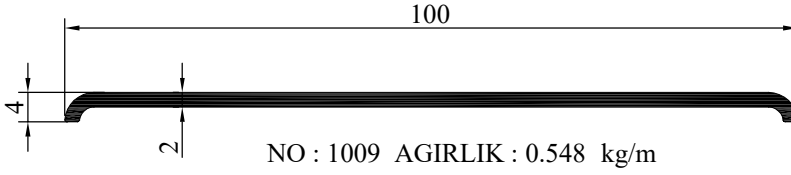

NO : 1009 AGIRLIK : 0.548 kg/m

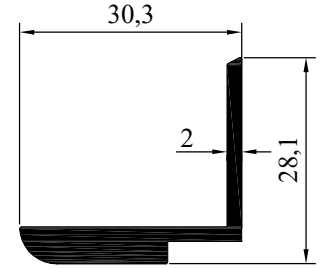

NO : 1354
AGIRLIK : 0.439 kg/m

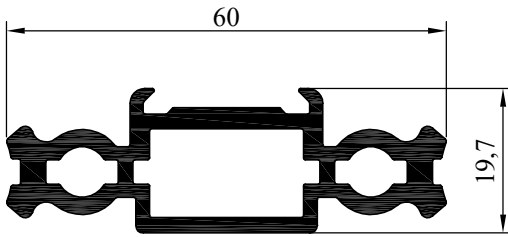

NO:7867 AĞIRLIK:1075 gr/m

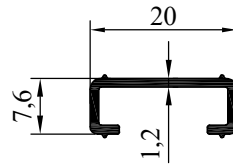

NO:6618 A
AĞIRLIK: 124 gr/m

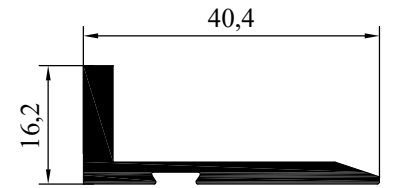

NO : 1274
AGIRLIK : 0.431 kg/m

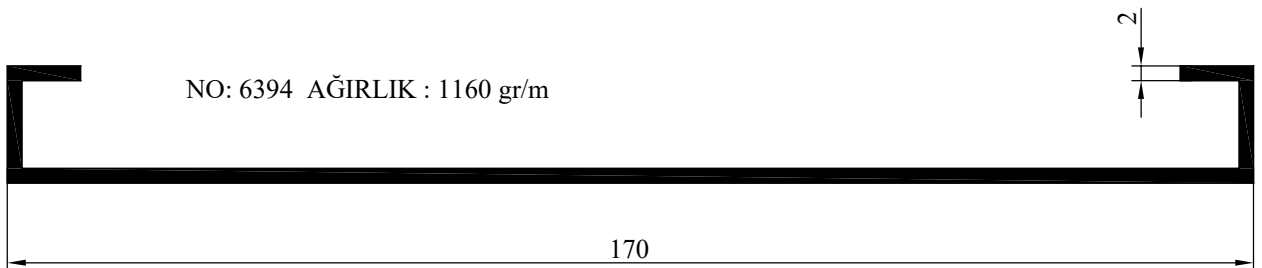

NO: 6394 AĞIRLIK : 1160 gr/m

MUHTELİF PROFİLLER

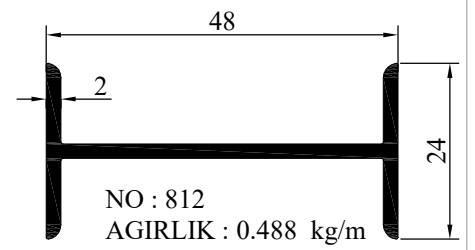
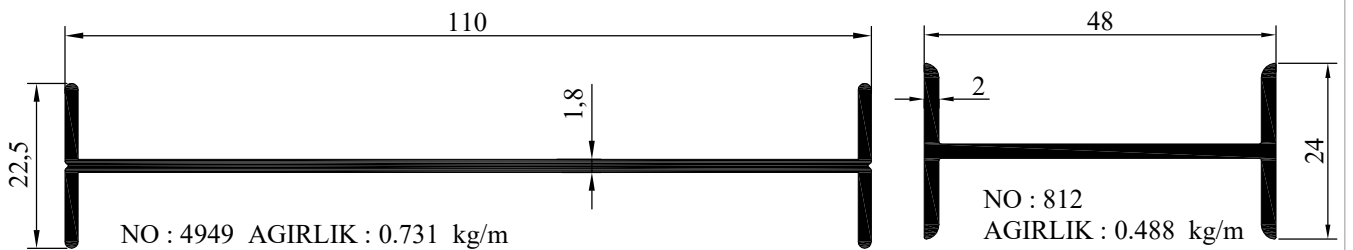
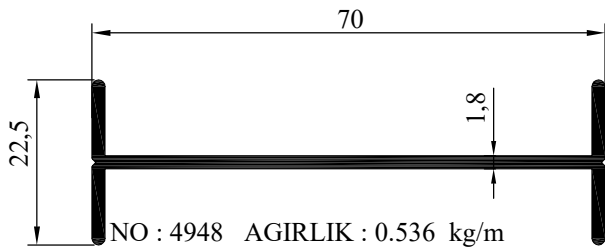
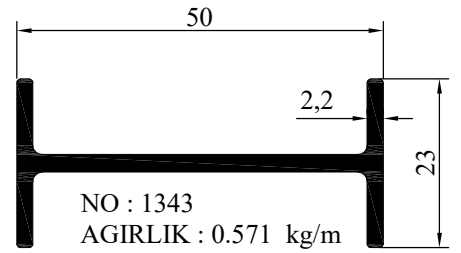
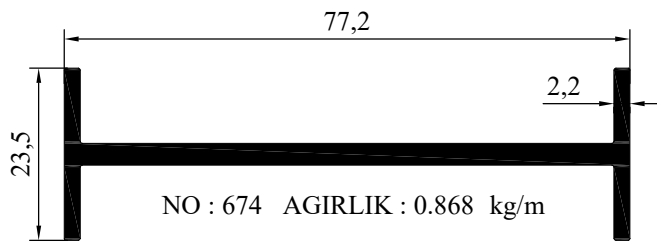
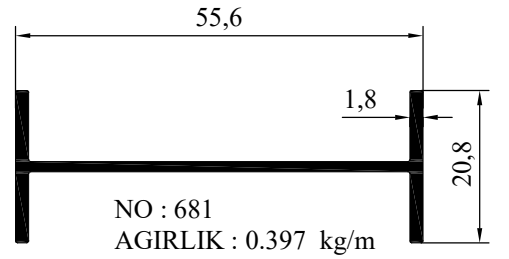
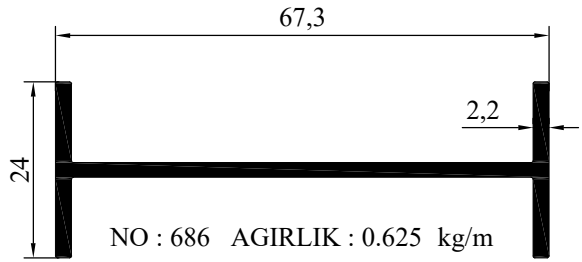
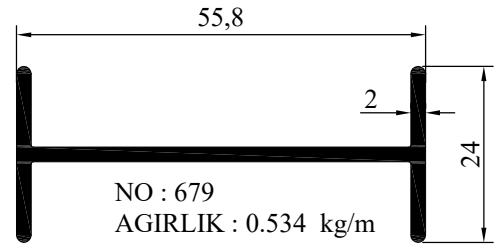
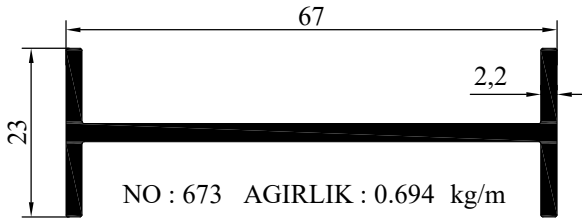
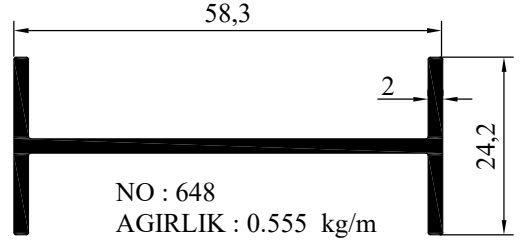
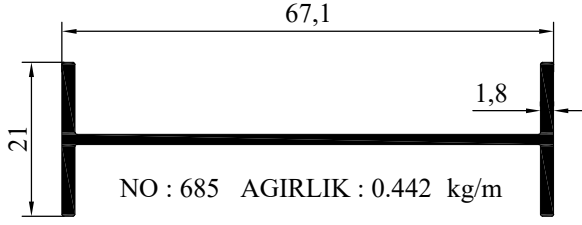

MUHTELİF PROFİLLER

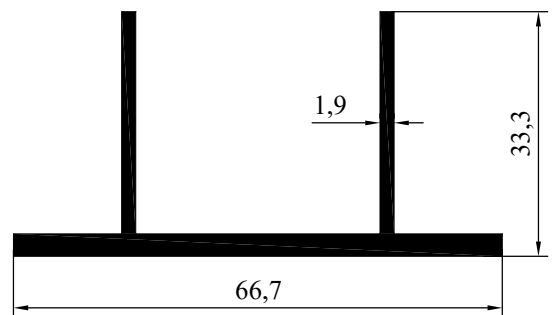
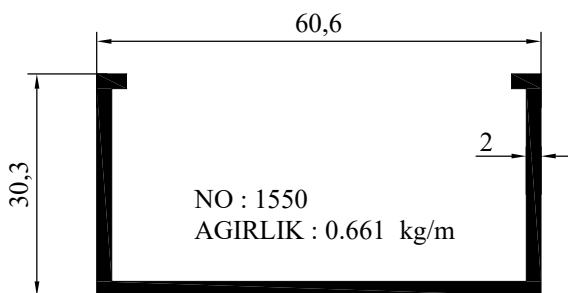
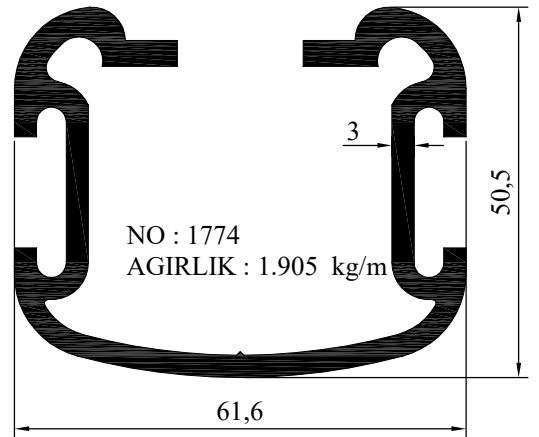
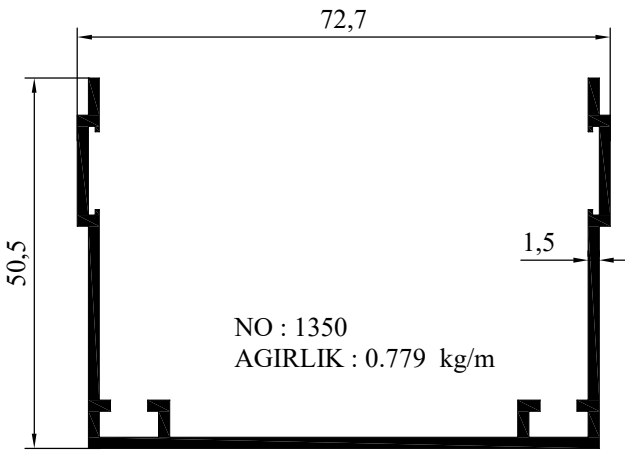
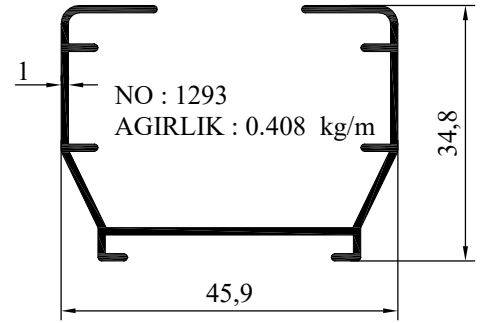
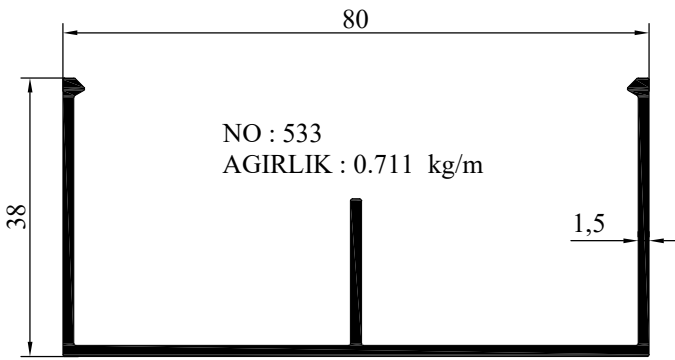
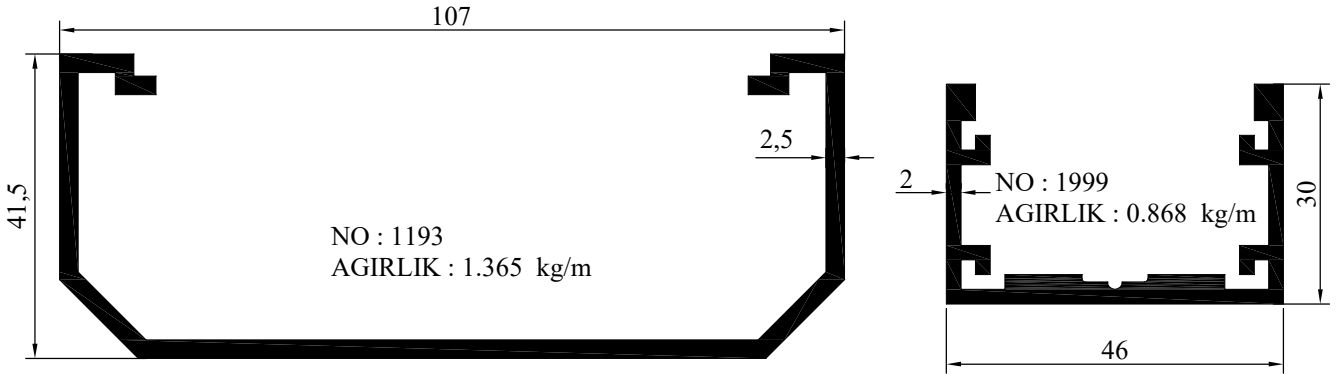

NO : 1797 AGIRLIK : 0.858 kg/m

MUHTELİF PROFİLLER

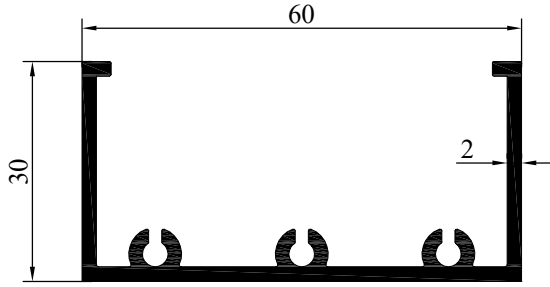

NO : 1551 AGIRLIK : 0.805 kg/m

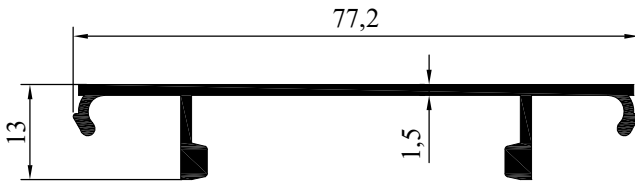

NO : 1848 AGIRLIK : 0.502 kg/m

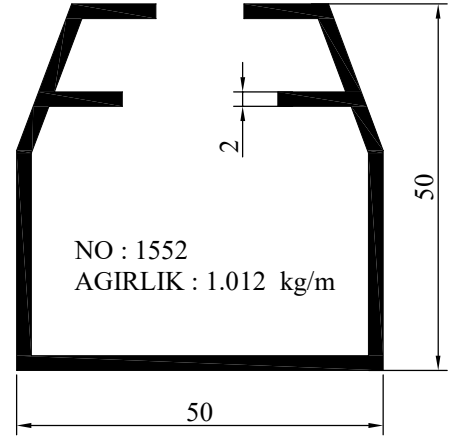

NO : 1552
AGIRLIK : 1.012 kg/m

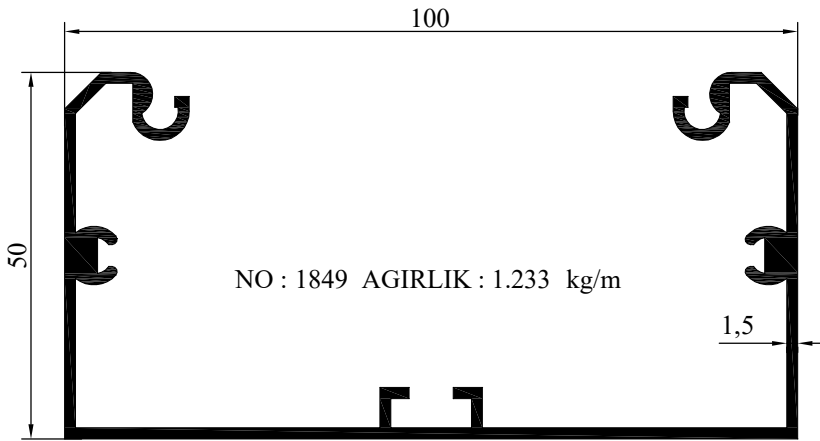

NO : 1849 AGIRLIK : 1.233 kg/m

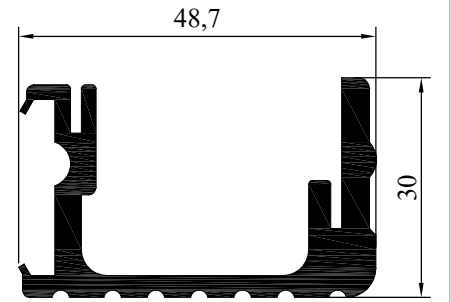

NO : 1829 AGIRLIK : 1.102 kg/m

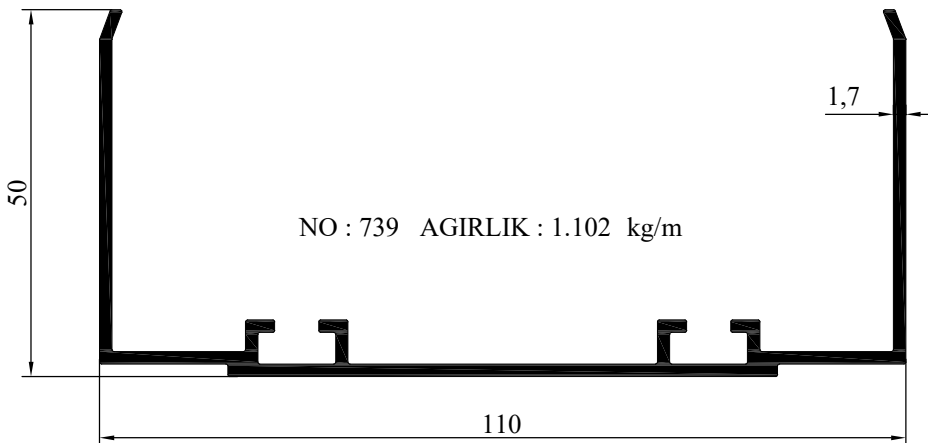

NO : 739 AGIRLIK : 1.102 kg/m

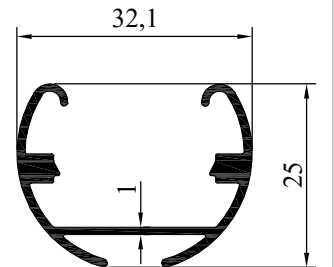

NO : 582 AGIRLIK : 0.346 kg/m

MUHTELİF PROFİLLER

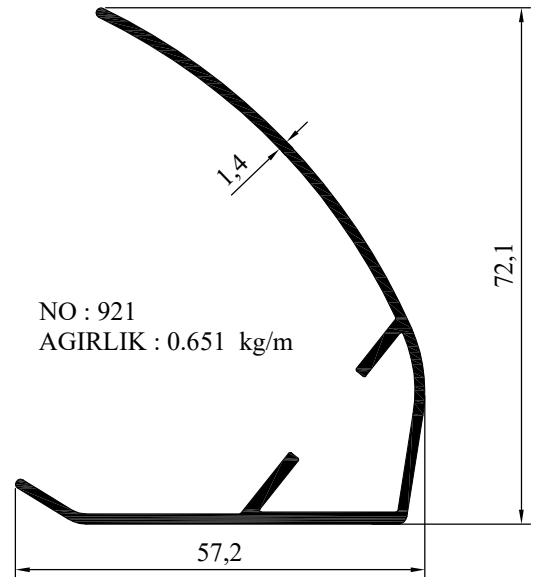
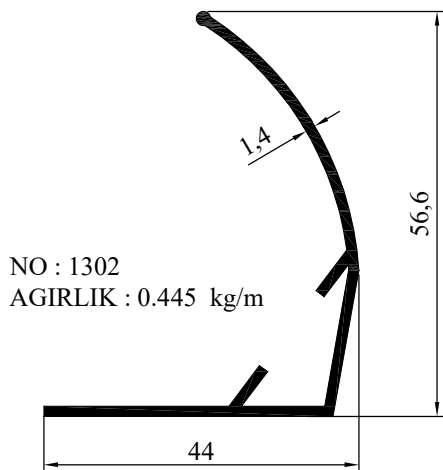
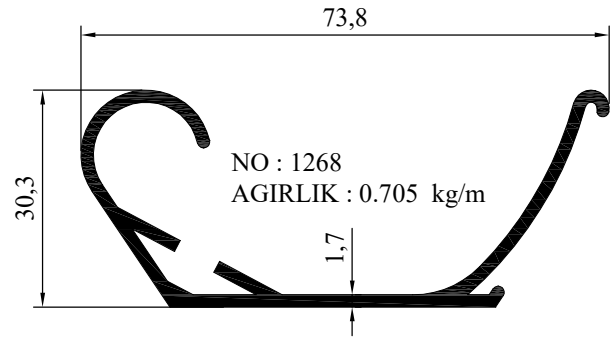
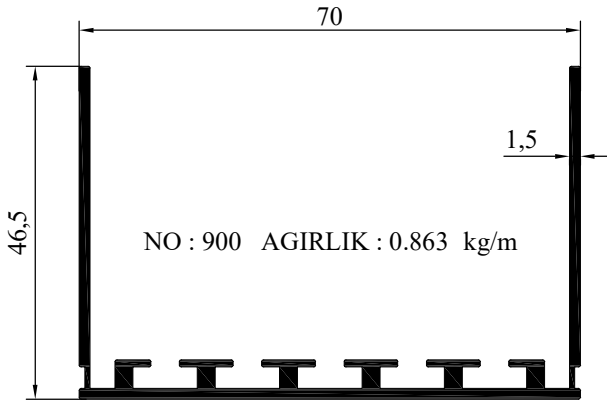
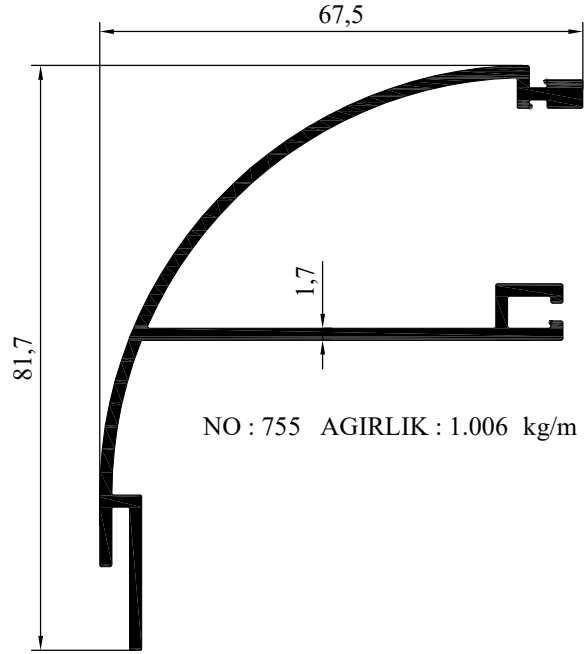
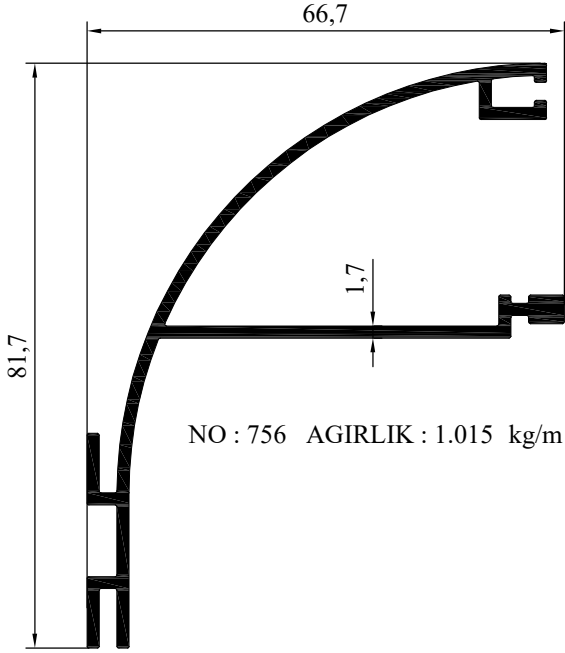

MUHTELİF PROFİLLER

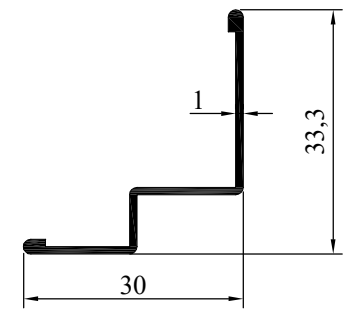
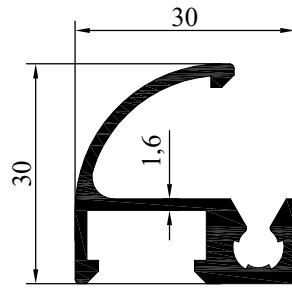
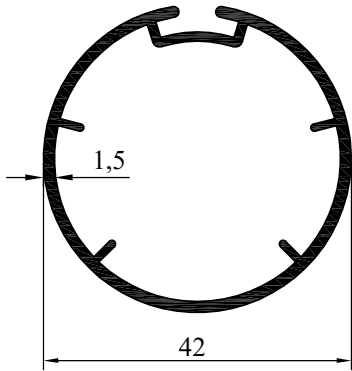
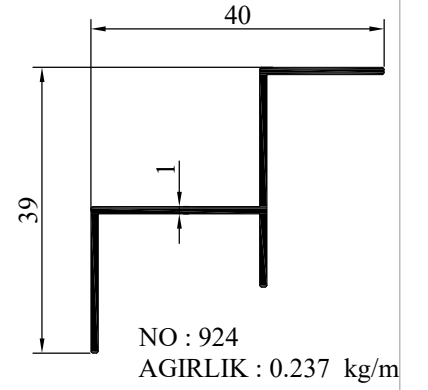
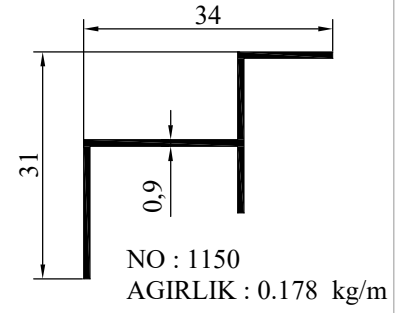
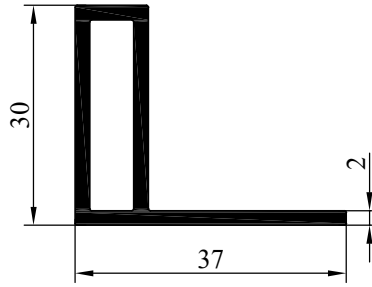
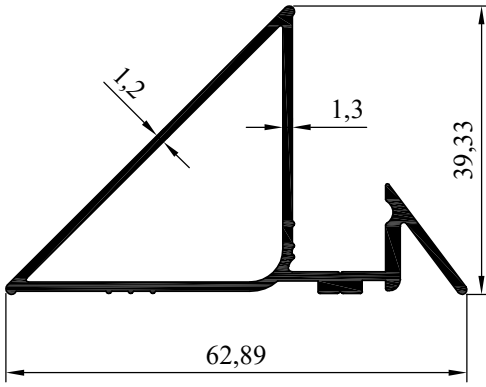
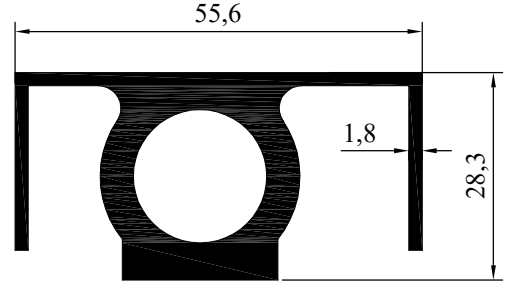
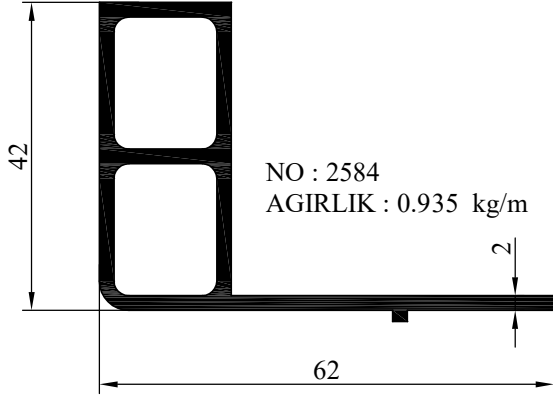

MUHTELİF PROFİLLER

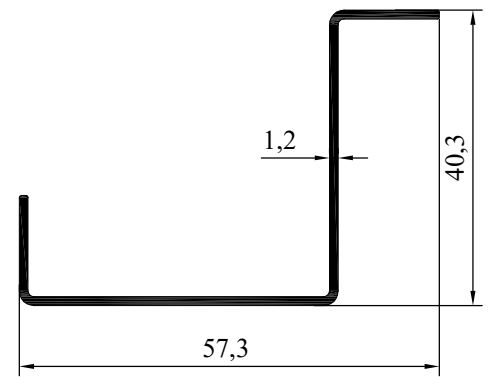
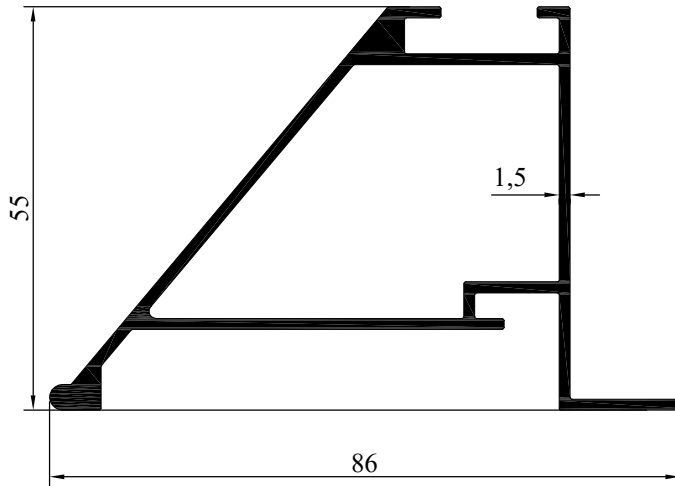
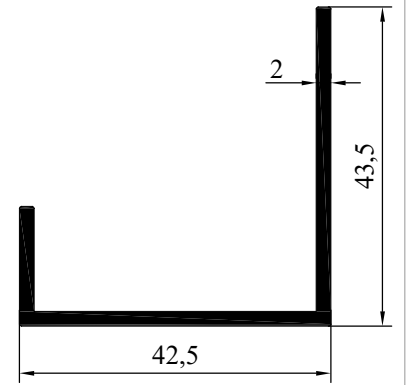
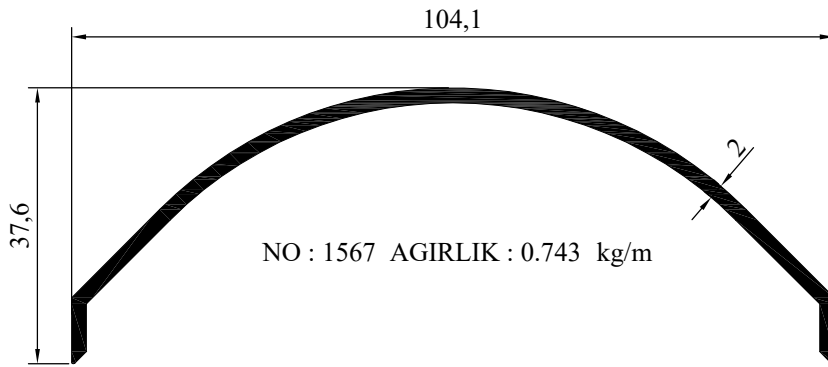
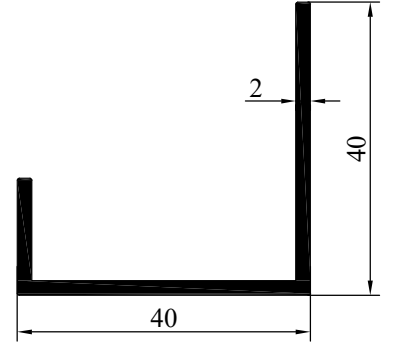
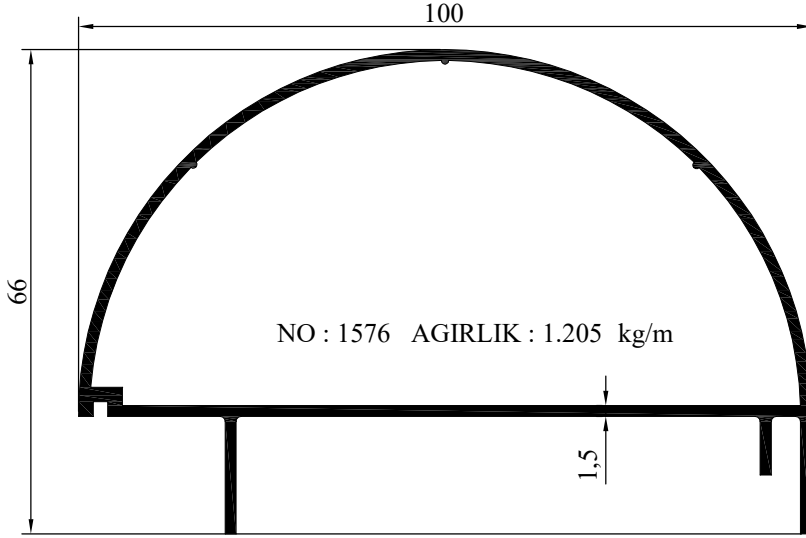

MUHTELİF PROFİLLER

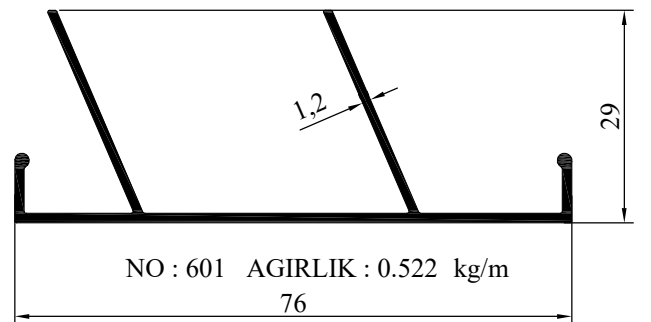
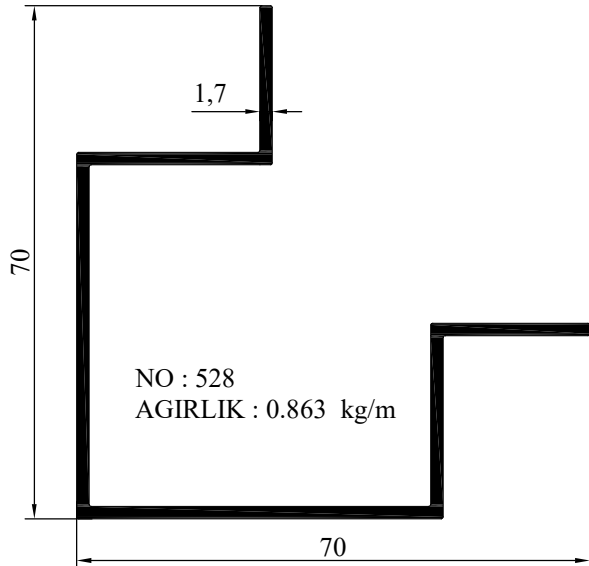
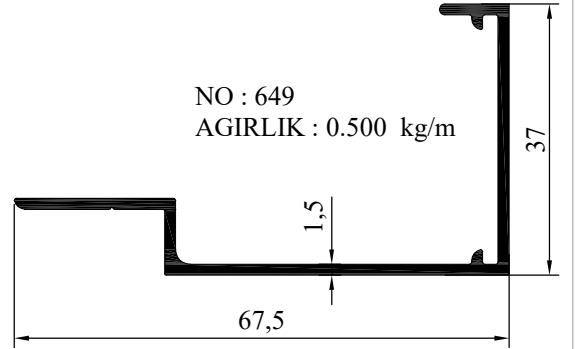
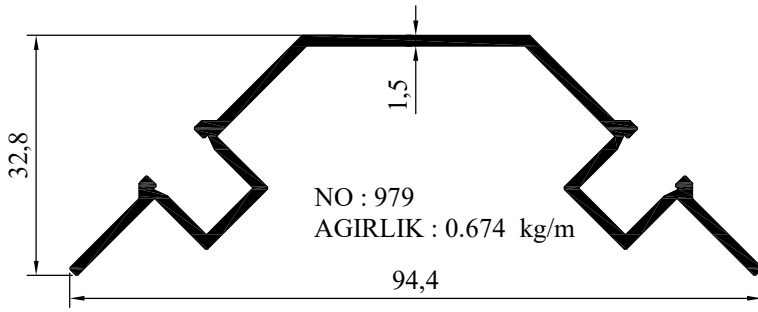
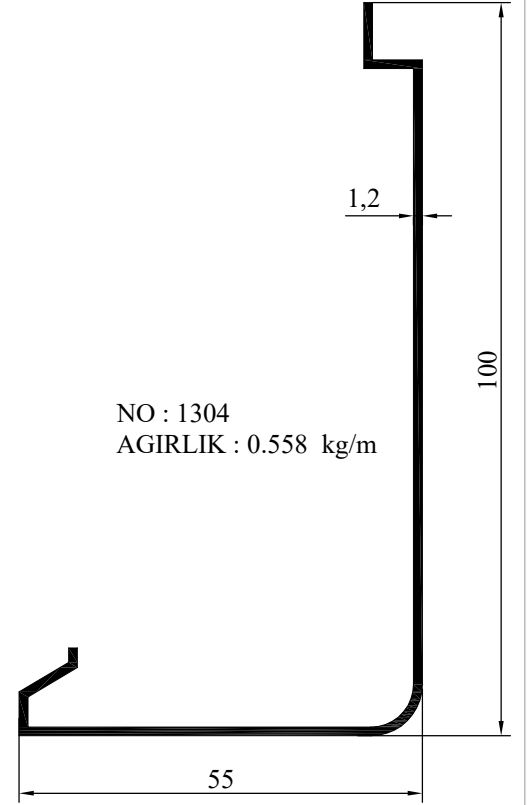
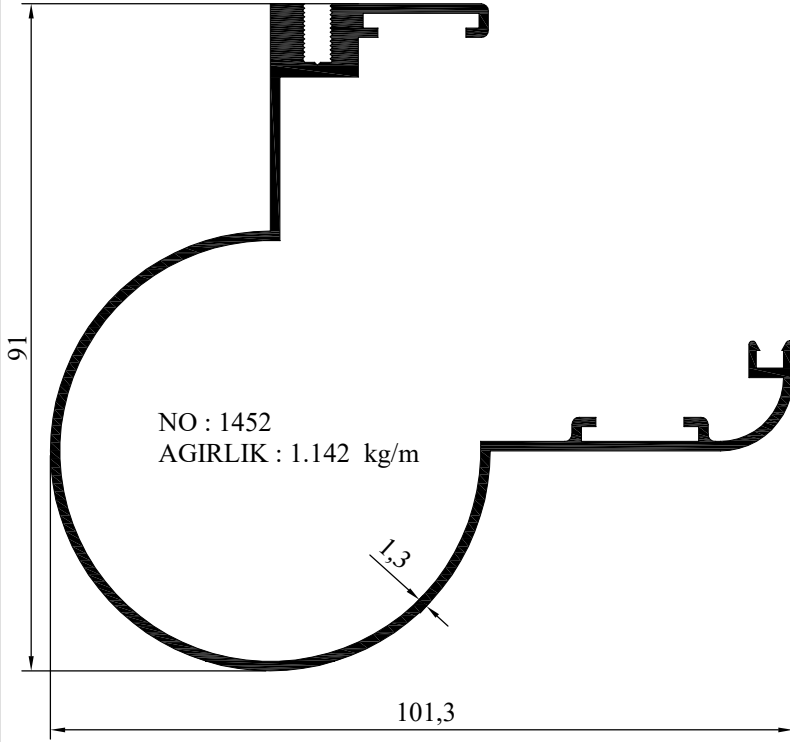

MUHTELİF PROFİLLER

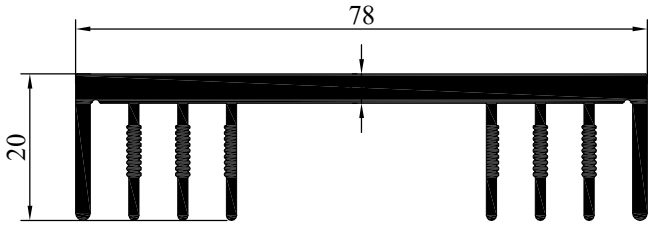

NO : 952 AGIRLIK : 1.405 kg/m

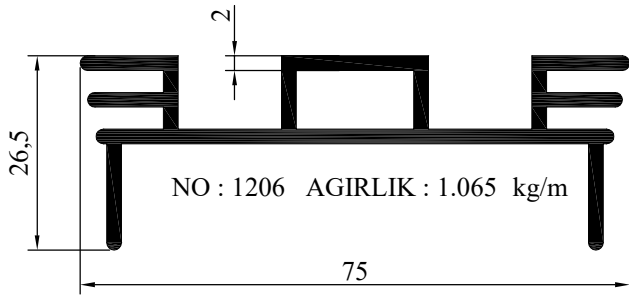

NO : 1206 AGIRLIK : 1.065 kg/m

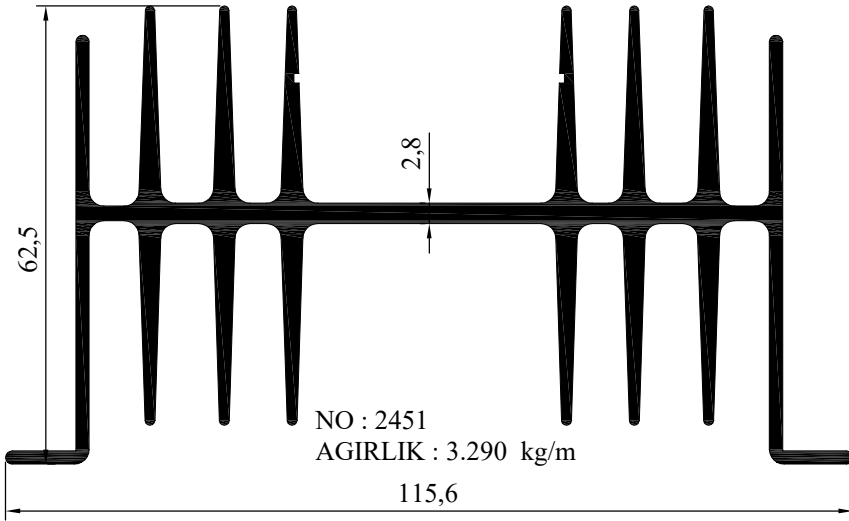

NO : 2451
AGIRLIK : 3.290 kg/m

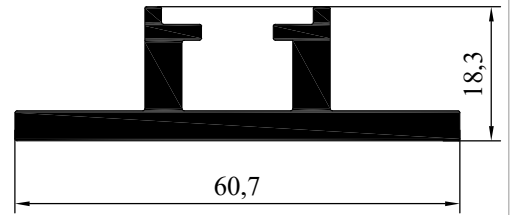

NO : 731
AGIRLIK : 1.058 kg/m

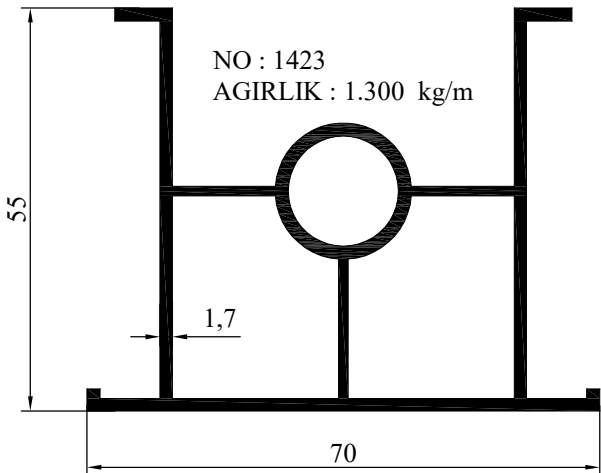

NO : 1423
AGIRLIK : 1.300 kg/m

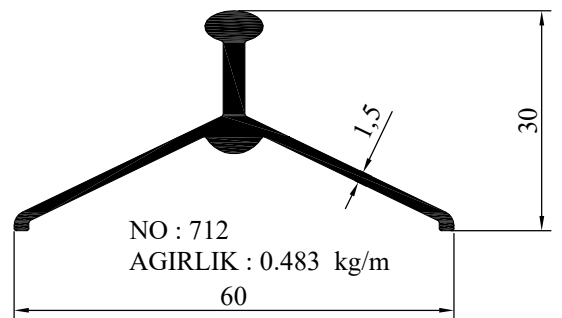

NO : 712
AGIRLIK : 0.483 kg/m

MUHTELİF PROFİLLER

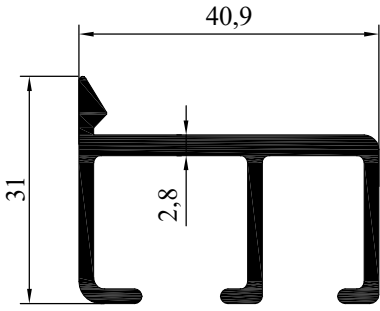

NO : 973
AGIRLIK : 0.756 kg/m

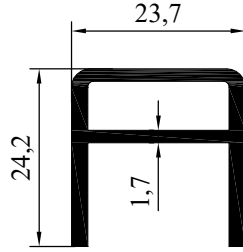

NO : 1171
AGIRLIK : 0.462 kg/m

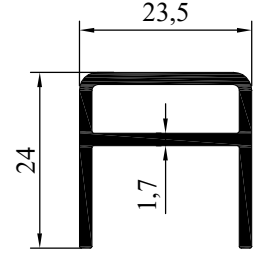

NO : 514
AGIRLIK : 0.397 kg/m

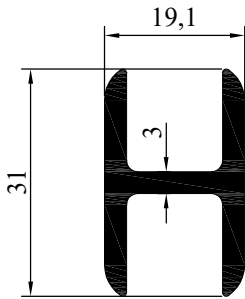

NO : 1231
AGIRLIK : 0.581 kg/m

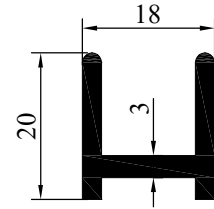

NO : 1478
AGIRLIK : 0.380 kg/m

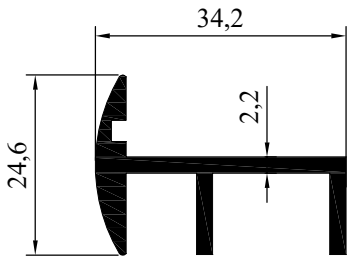

NO : 1024
AGIRLIK : 0.500 kg/m

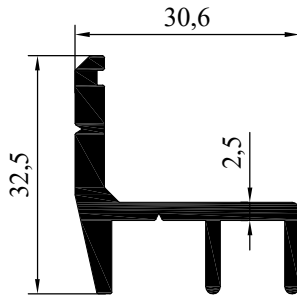

NO : 1006
AGIRLIK : 0.599 kg/m

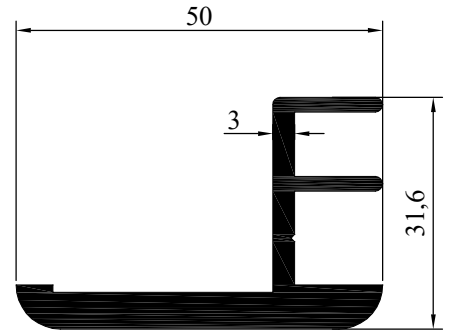

NO : 1190
AGIRLIK : 1.020 kg/m

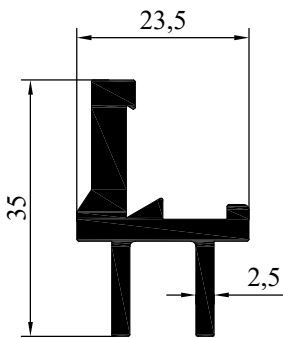

NO : 911
AGIRLIK : 0.673 kg/m

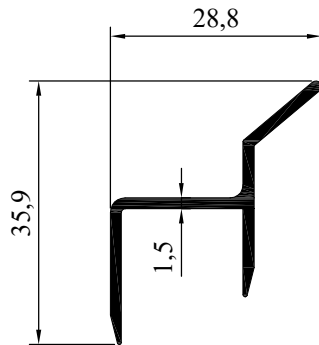

NO : 990
AGIRLIK : 0.272 kg/m

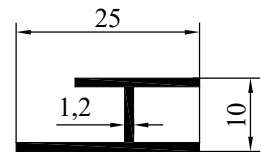

NO : 1485
AGIRLIK : 0.160 kg/m

MUHTELİF PROFİLLER

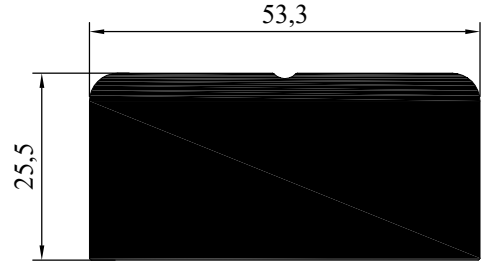
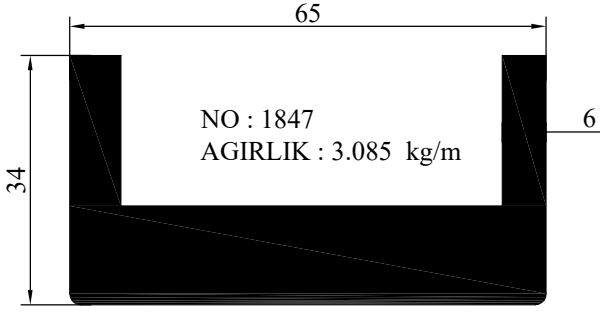

NO : 919
AGIRLIK : 3.645 kg/m

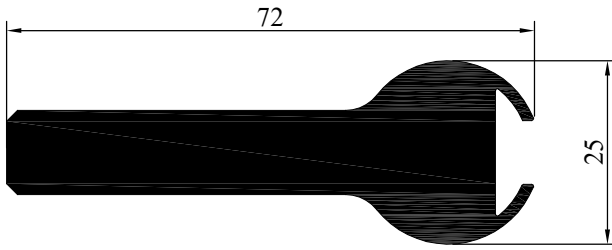

NO : 1296 AGIRLIK : 2.632 kg/m

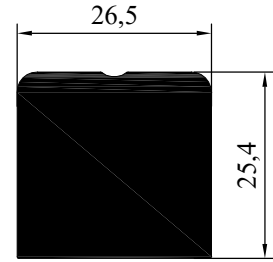

NO : 920
AGIRLIK : 1.807 kg/m

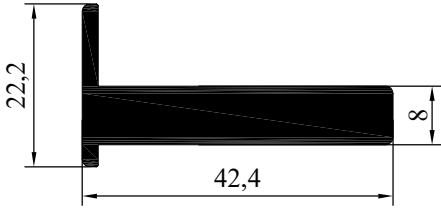

NO : 970 AGIRLIK : 0.997 kg/m

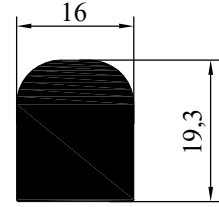

NO : 576
AGIRLIK : 0.792 kg/m

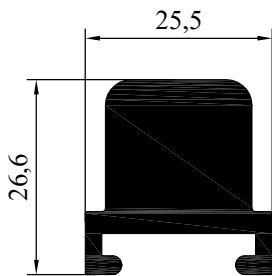

NO : 969
AGIRLIK : 1.267 kg/m

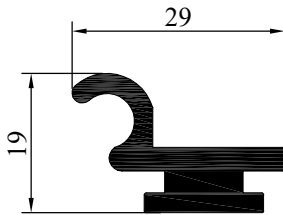

NO : 972
AGIRLIK : 0.535 kg/m

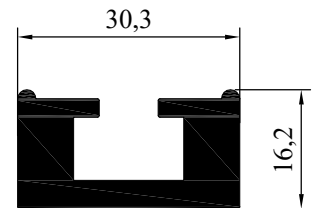

NO : 968
AGIRLIK : 0.837 kg/m

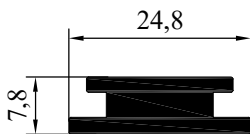

NO : 967
AGIRLIK : 0.401 kg/m

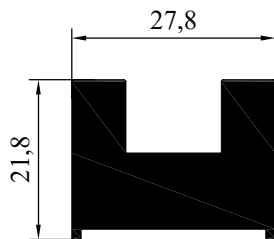

NO : 966
AGIRLIK : 1.189 kg/m

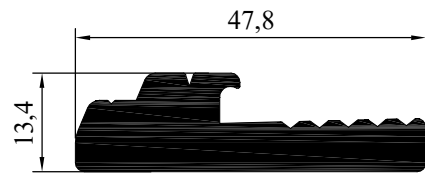

NO : 922
AGIRLIK : 1.128 kg/m

MUHTELİF PROFİLLER

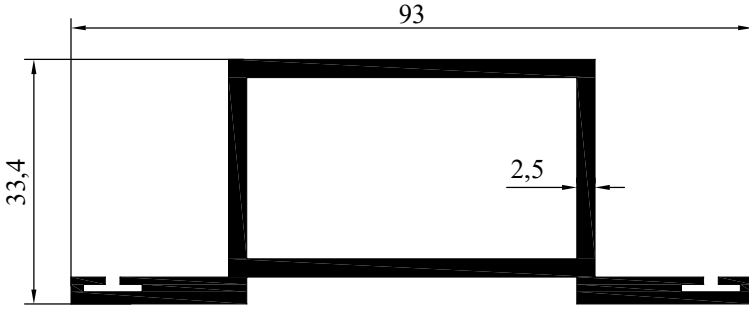

NO : 1488 AGIRLIK : 1.430 kg/m

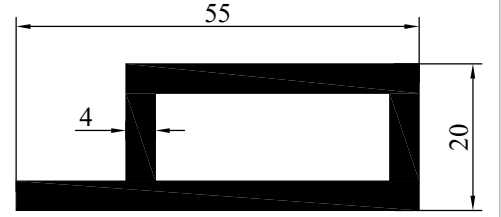

NO : 1933 AGIRLIK : 1.285 kg/m

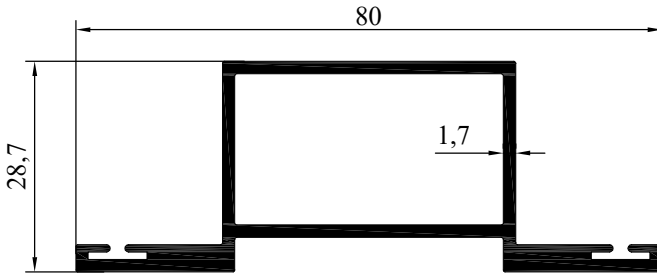

NO : 1461 AGIRLIK : 0.940 kg/m

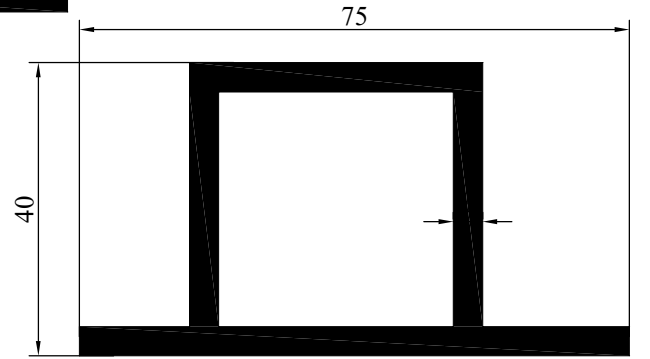

NO : 1932 AGIRLIK : 1.933 kg/m

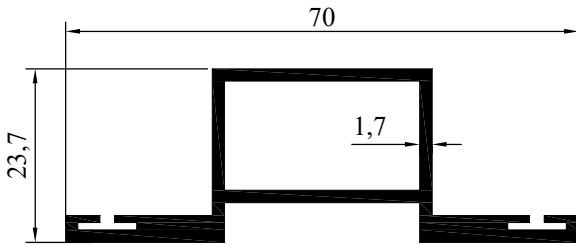

NO : 1466 AGIRLIK : 0.805 kg/m

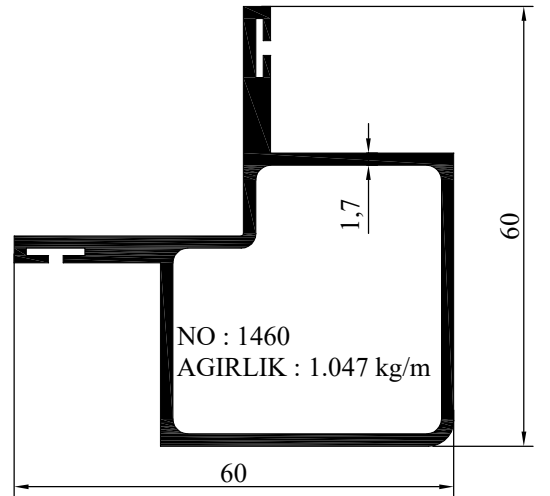

NO : 1460
AGIRLIK : 1.047 kg/m

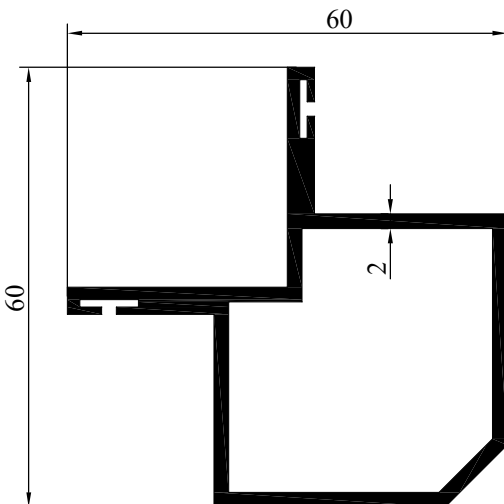

NO : 1635 AGIRLIK : 1.140 kg/m

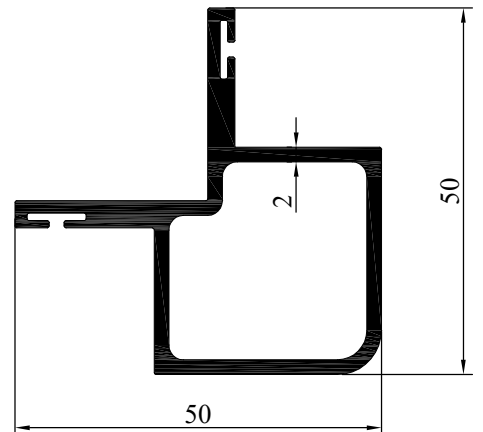

NO : 1465 AGIRLIK : 0.950 kg/m

MUHTELİF PROFİLLER

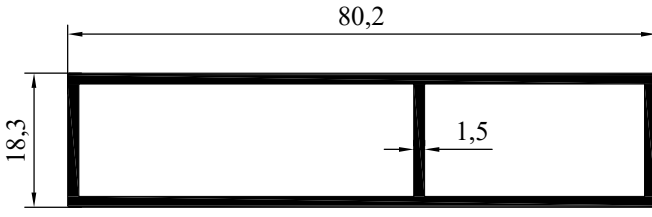

NO : 1630 AGIRLIK : 0.835 kg/m

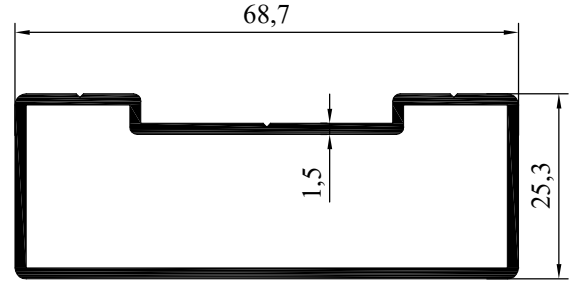

NO : 1723 AGIRLIK : 0.767 kg/m

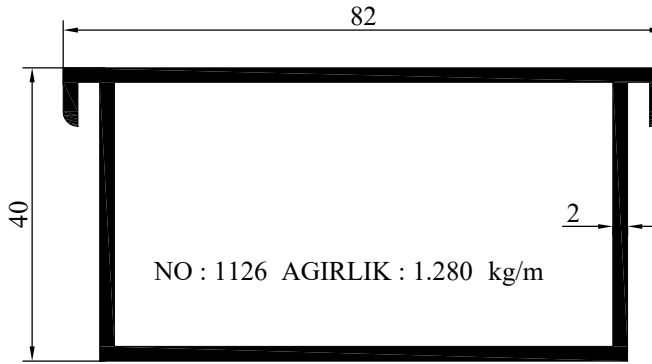

NO : 1126 AGIRLIK : 1.280 kg/m

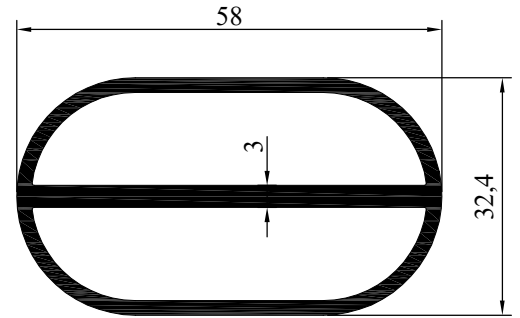

NO : 633 AGIRLIK : 1.229 kg/m

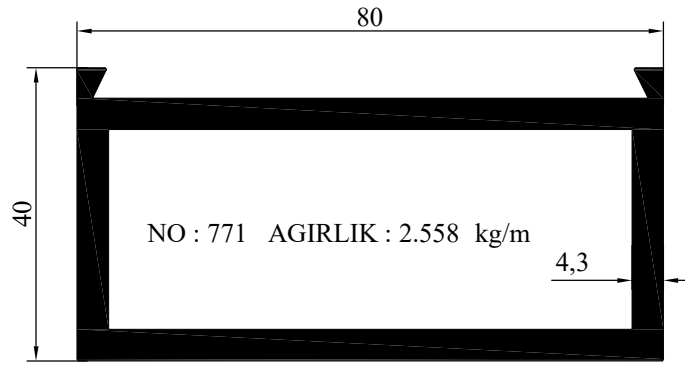

NO : 771 AGIRLIK : 2.558 kg/m

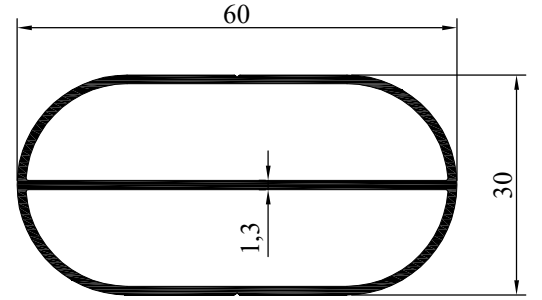

NO : 1724 AGIRLIK : 0.668 kg/m

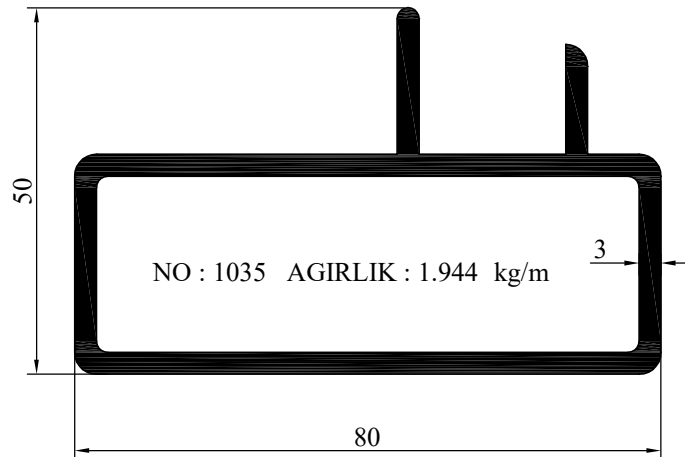

NO : 1035 AGIRLIK : 1.944 kg/m

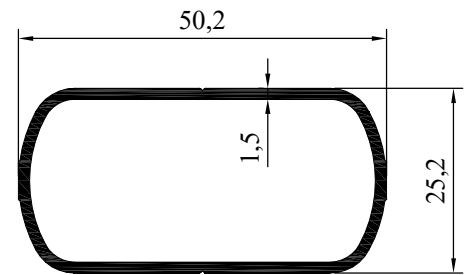

NO : 828 AGIRLIK : 0.529 kg/m

MUHTELİF PROFİLLER

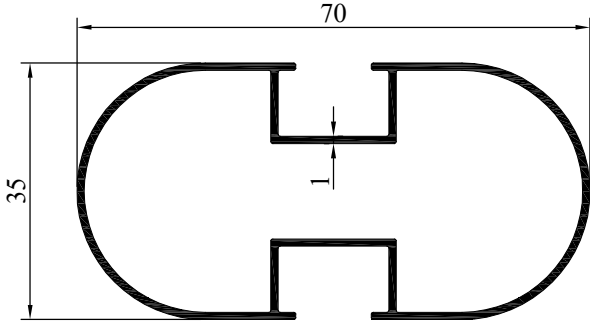

NO : 620 AGIRLIK : 0.611 kg/m

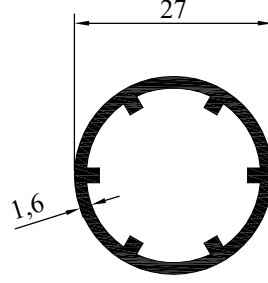

NO : 1230
AGIRLIK : 0.401 kg/m

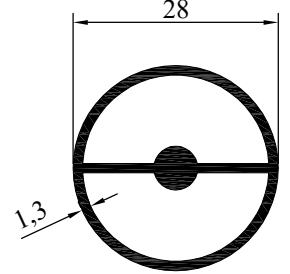

NO : 870
AGIRLIK : 0.428 kg/m

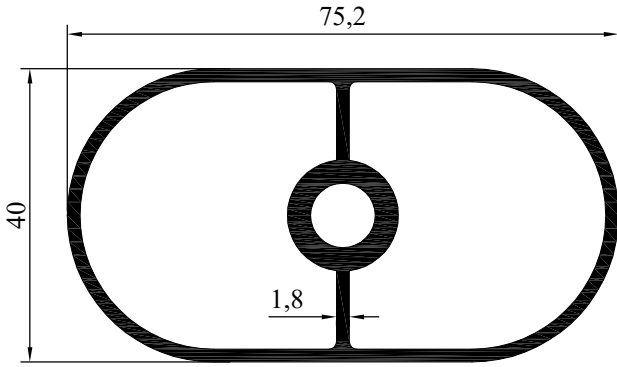

NO : 1311 AGIRLIK : 1.332 kg/m

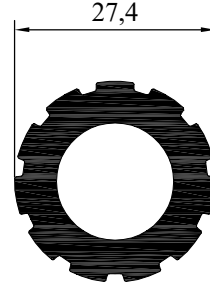

NO : 629
AGIRLIK : 0.973 kg/m

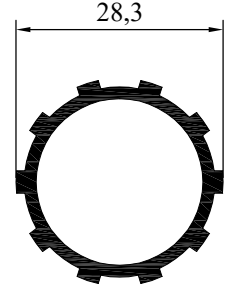

NO : 1722
AGIRLIK : 0.429 kg/m

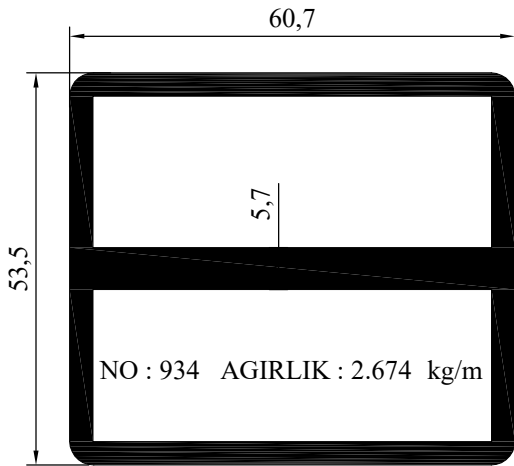

NO : 934 AGIRLIK : 2.674 kg/m

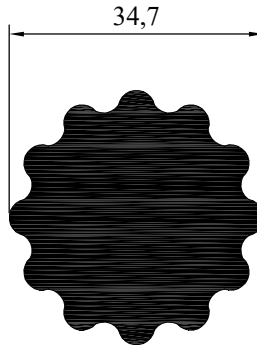

NO : 640
AGIRLIK : 2.215 kg/m

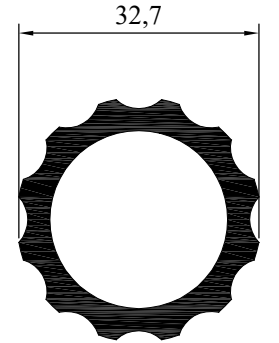

NO : 1556
AGIRLIK : 0.902 kg/m

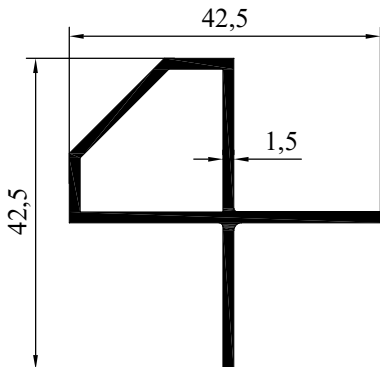

NO : 1637 AGIRLIK : 0.470 kg/m

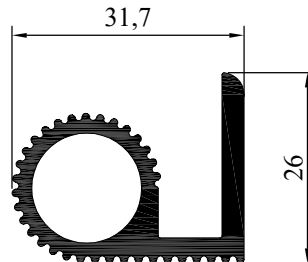

NO : 521
AGIRLIK : 0.654 kg/m

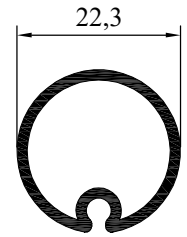

NO : 1768
AGIRLIK : 0.281 kg/m

MUHTELİF PROFİLLER

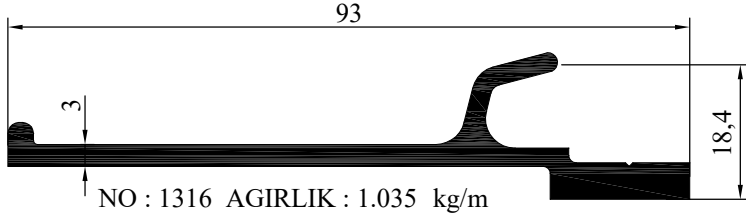

NO : 1316 AGIRLIK : 1.035 kg/m

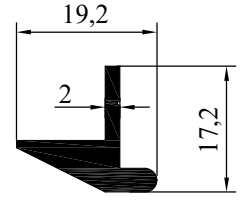

NO : 1665
AGIRLIK : 0.266 kg/m

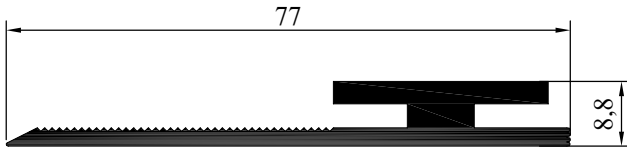

NO : 1341 AGIRLIK : 0.803 kg/m

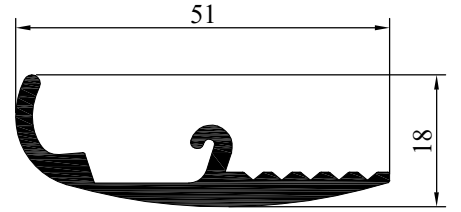

NO : 929
AGIRLIK : 0.544 kg/m

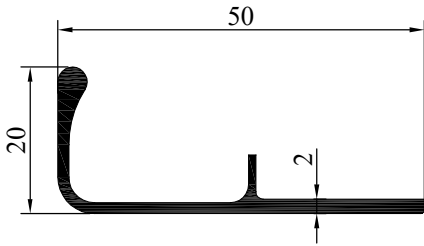

NO : 1170
AGIRLIK : 0.352 kg/m

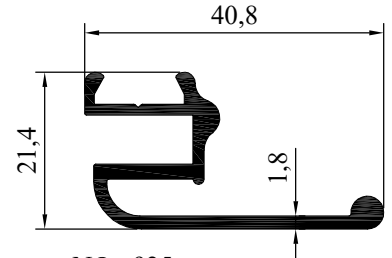

NO : 925
AGIRLIK : 0.475 kg/m

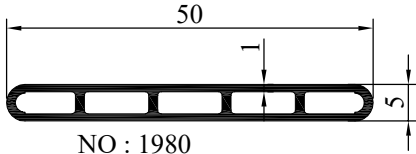

NO : 1980
AGIRLIK : 0.323 kg/m

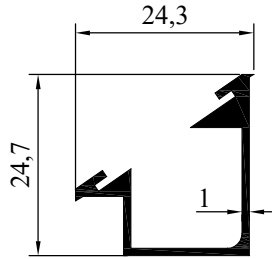

NO : 1306
AGIRLIK : 0.241 kg/m

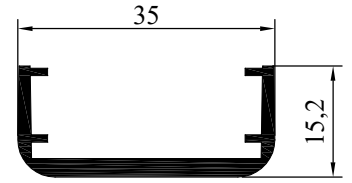

NO : 1541
AGIRLIK : 0.350 kg/m

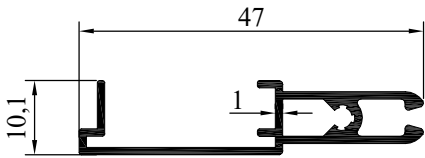

NO : 1148
AGIRLIK : 0.296 kg/m

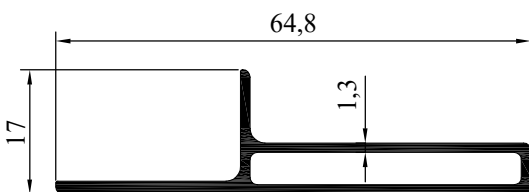

NO : 958 AGIRLIK : 0.470 kg/m

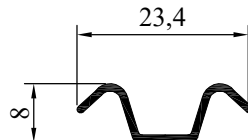

NO : 786
AGIRLIK : 0.095 kg/m

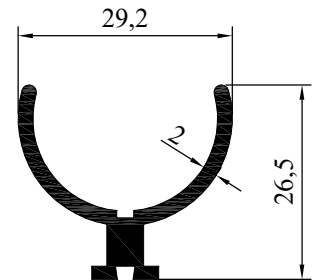

NO : 1018
AGIRLIK : 0.382 kg/m

MUHTELİF PROFİLLER

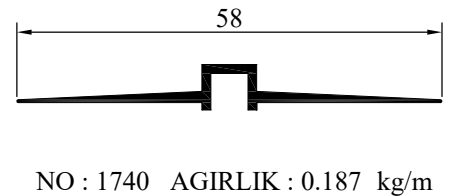
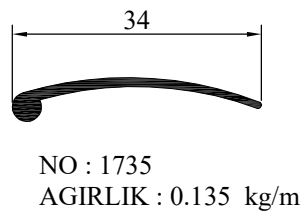
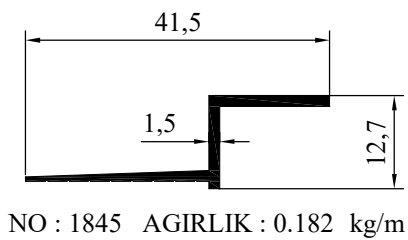
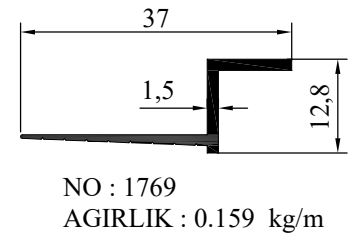
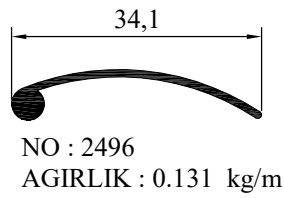
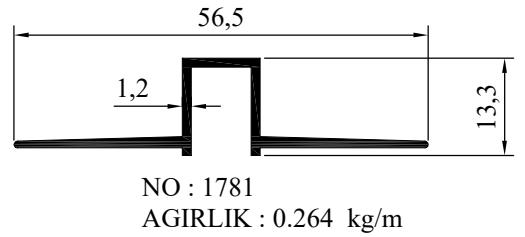
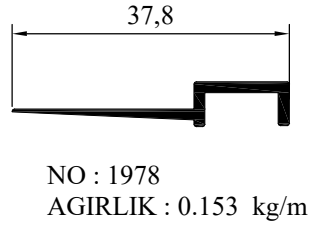
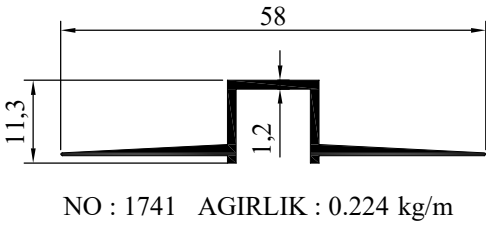
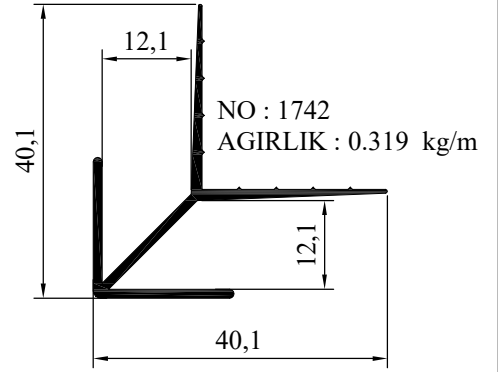
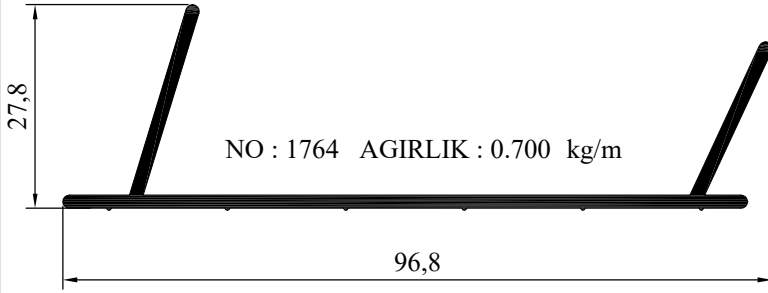
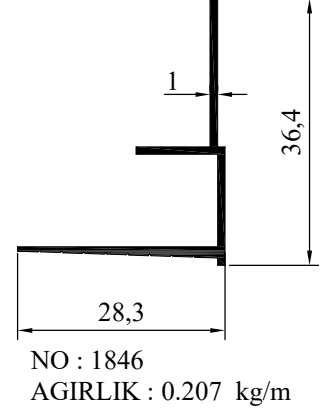
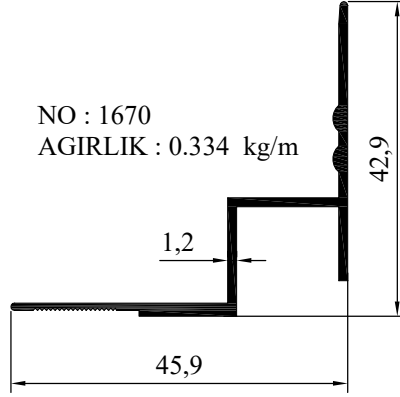
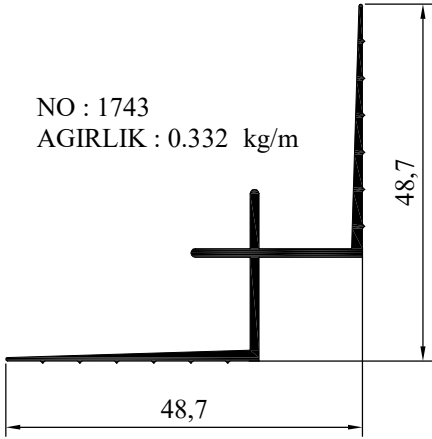

MUHTELİF PROFİLLER

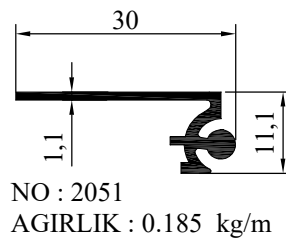
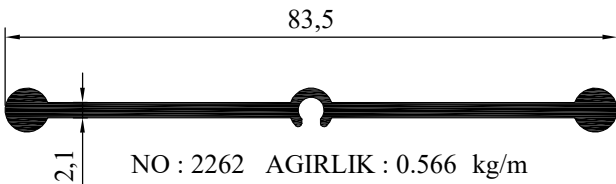
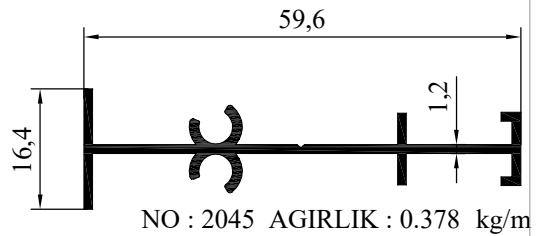
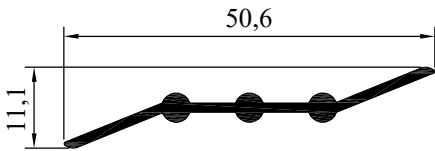
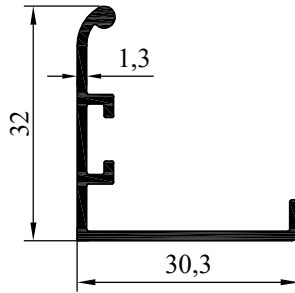
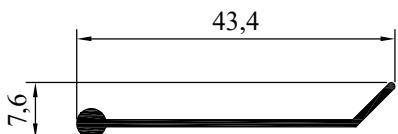
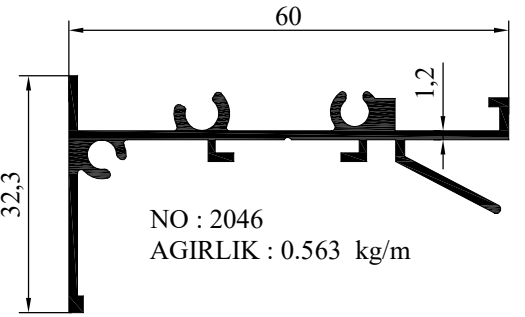
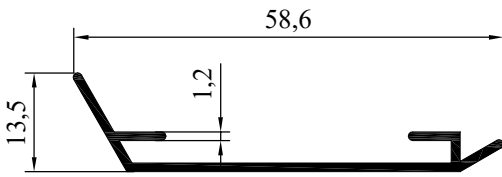
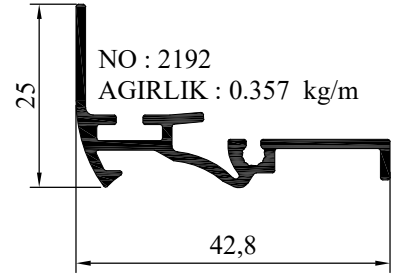
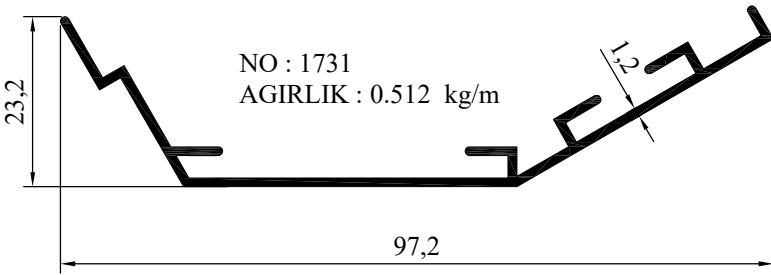
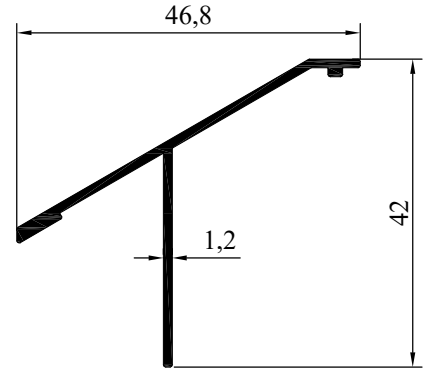
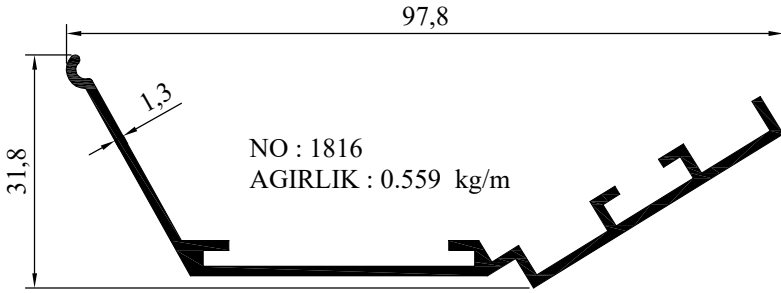

MUHTELİF PROFİLLER

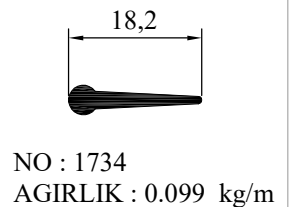
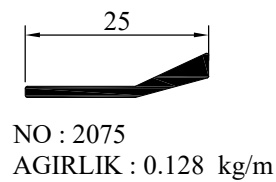
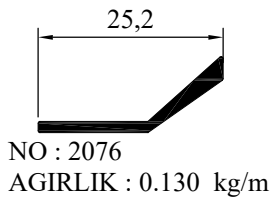
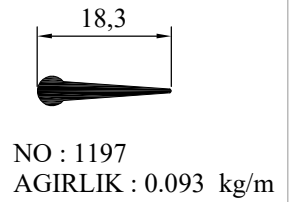
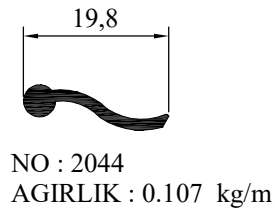
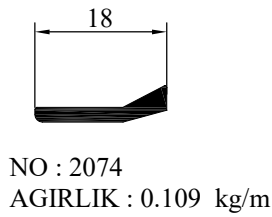
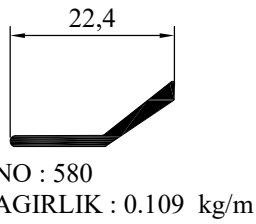
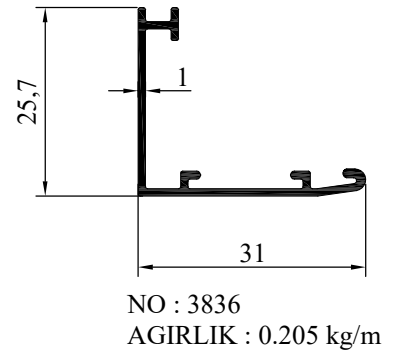
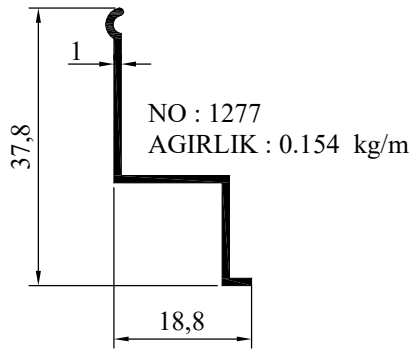
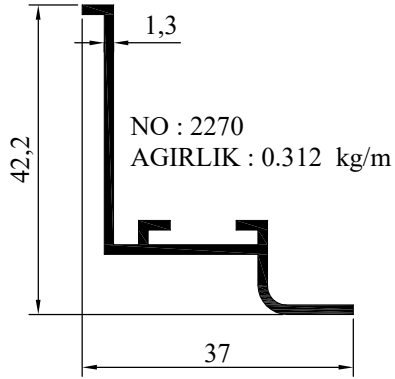
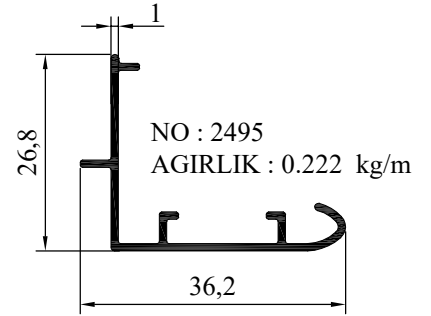
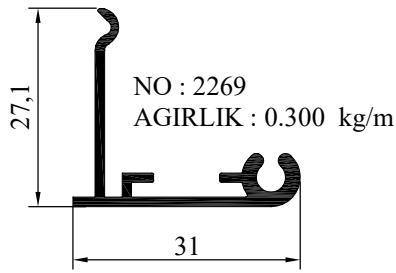
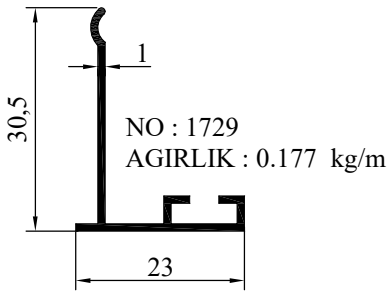
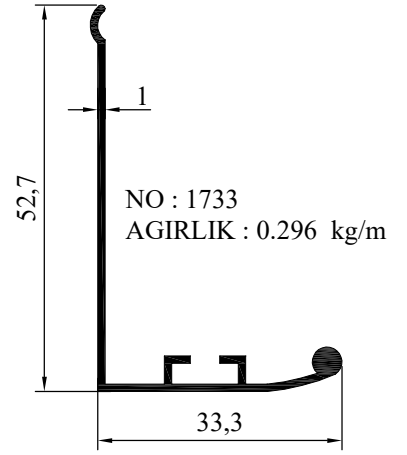
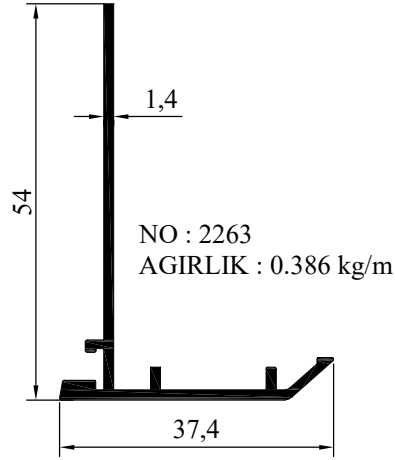
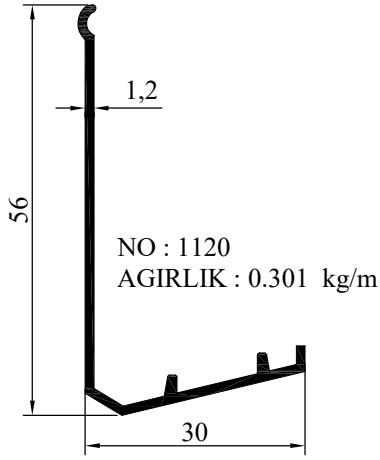

MUHTELİF PROFİLLER

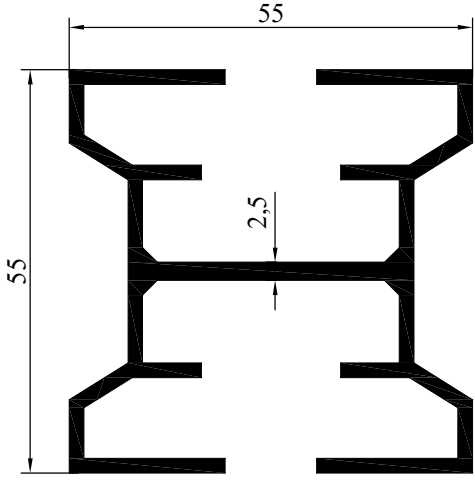

NO : 1487 AGIRLIK : 1.542 kg/m

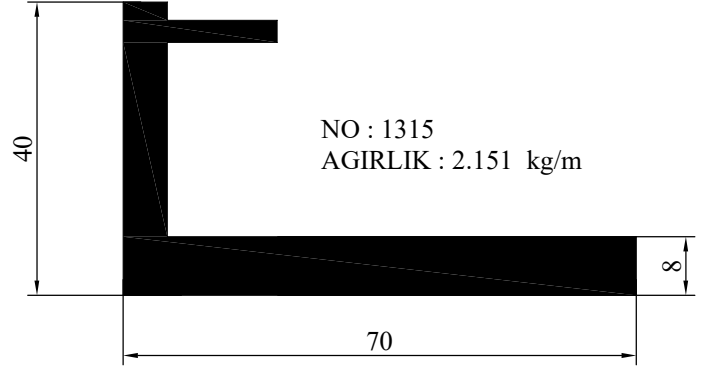

NO : 1315
AGIRLIK : 2.151 kg/m

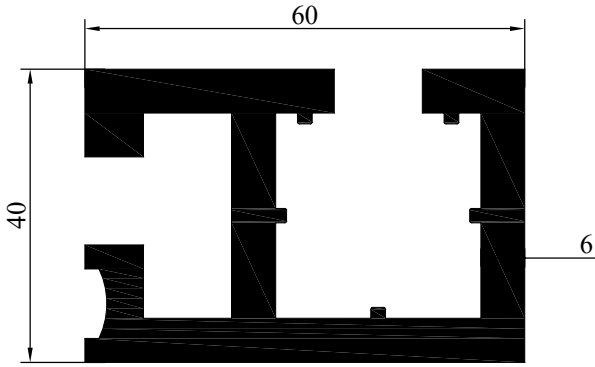

NO : 1486 AGIRLIK : 2.974 kg/m

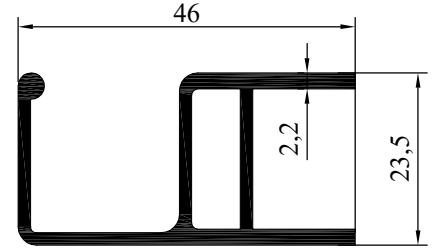

NO : 1172
AGIRLIK : 0.670 kg/m

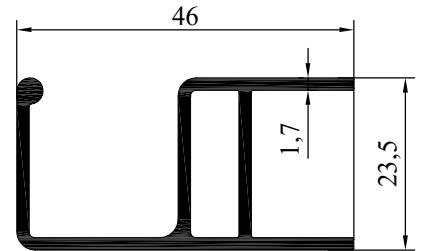

NO : 753
AGIRLIK : 0.614 kg/m

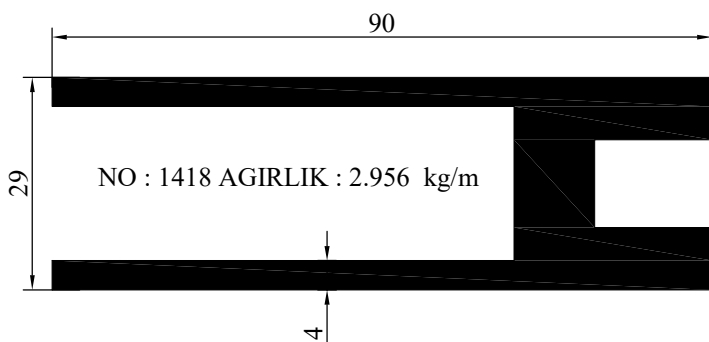

NO : 1418 AGIRLIK : 2.956 kg/m

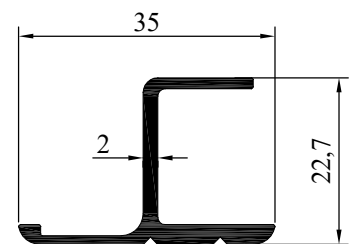

NO : 865
AGIRLIK : 0.348 kg/m

MUHTELİF PROFİLLER

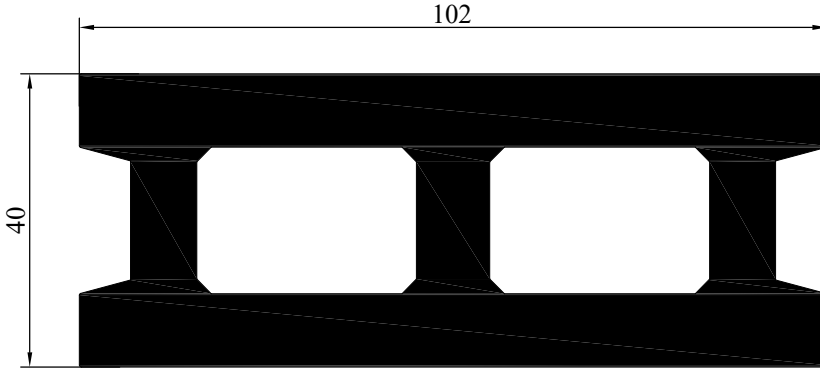

NO : 1000 AGIRLIK : 7.132 kg/m

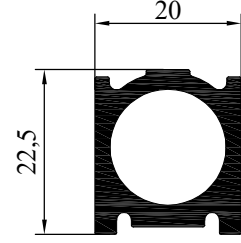

NO : 917 AGIRLIK : 0.566 kg/m



NO : 1208 AGIRLIK : 0.719 kg/m

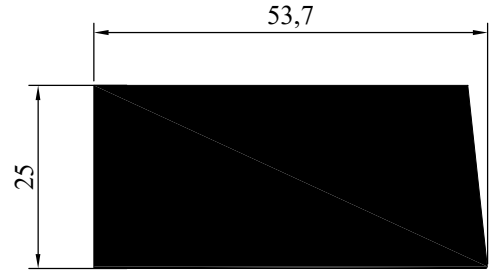

NO : 1209 AGIRLIK : 3.532 kg/m

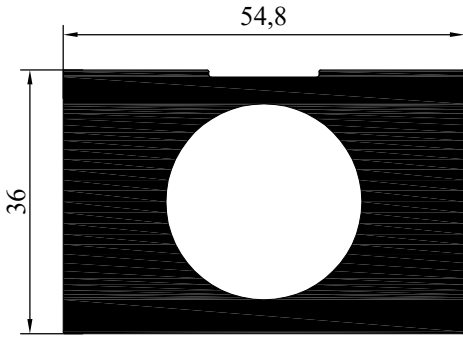

NO : 677 AGIRLIK : 3.769 kg/m

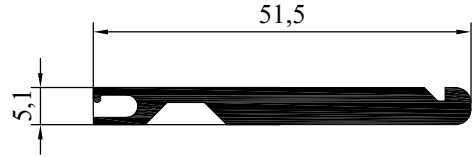

NO : 1655 AGIRLIK : 0.578 kg/m

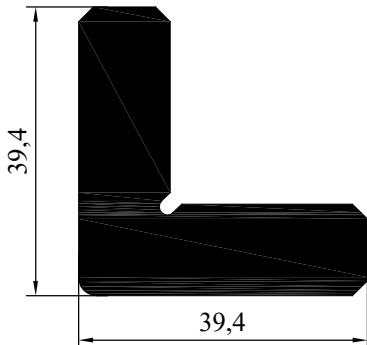

NO : 1752 AGIRLIK : 2.199 kg/m

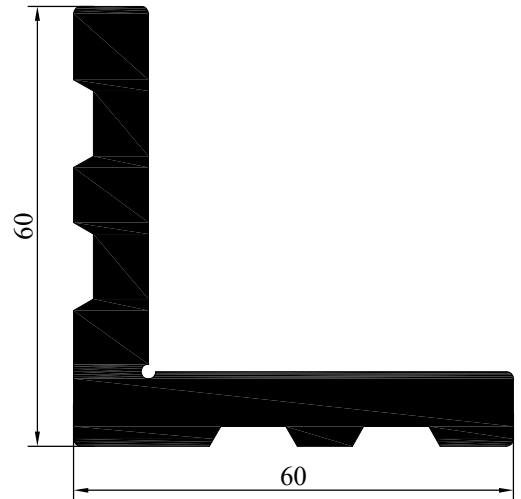

NO : 1194 AGIRLIK : 2.711 kg/m

MUHTELİF PROFİLLER

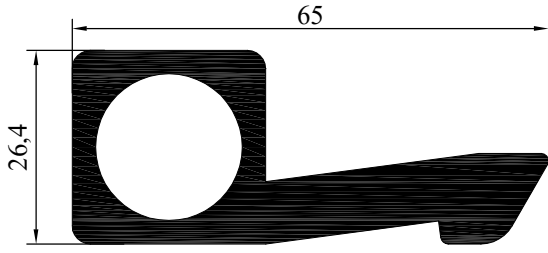

NO : 1007 AGIRLIK : 1.955 kg/m

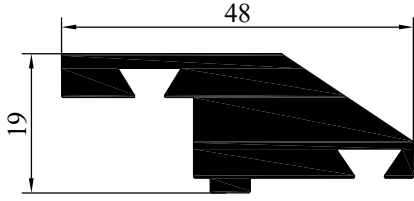

NO : 1002 AGIRLIK : 1.272 kg/m

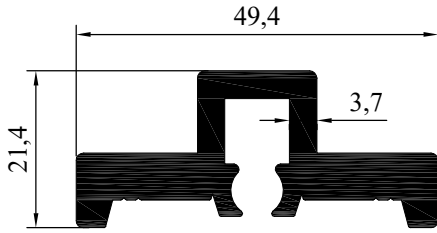

NO : 999 AGIRLIK : 1.172 kg/m

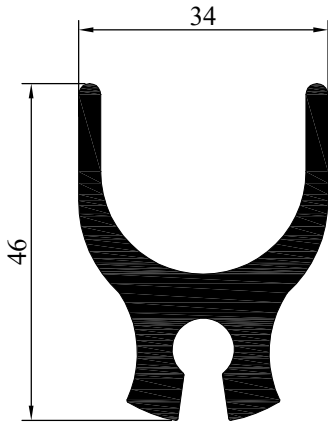

NO : 963 AGIRLIK : 1.392 kg/m

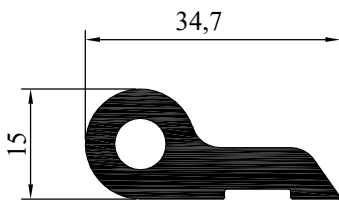

NO : 578 AGIRLIK : 0.708 kg/m

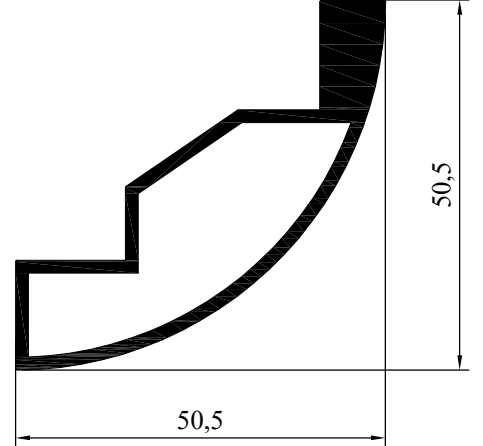

NO : 1013 AGIRLIK : 0.964 kg/m

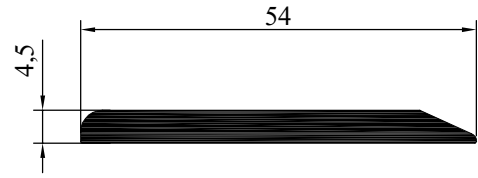

NO : 572 AGIRLIK : 0.614 kg/m

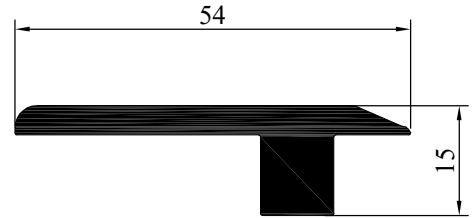

NO : 573 AGIRLIK : 0.840 kg/m

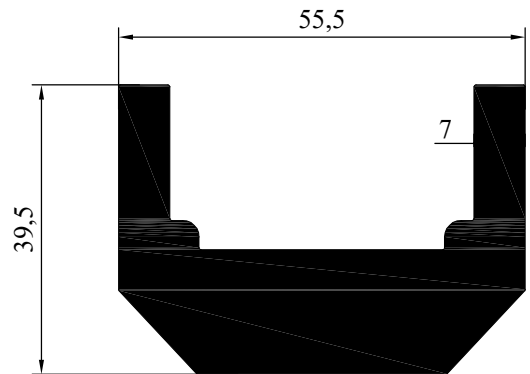

NO : 574 AGIRLIK : 3.143 kg/m

MUHTELİF PROFİLLER

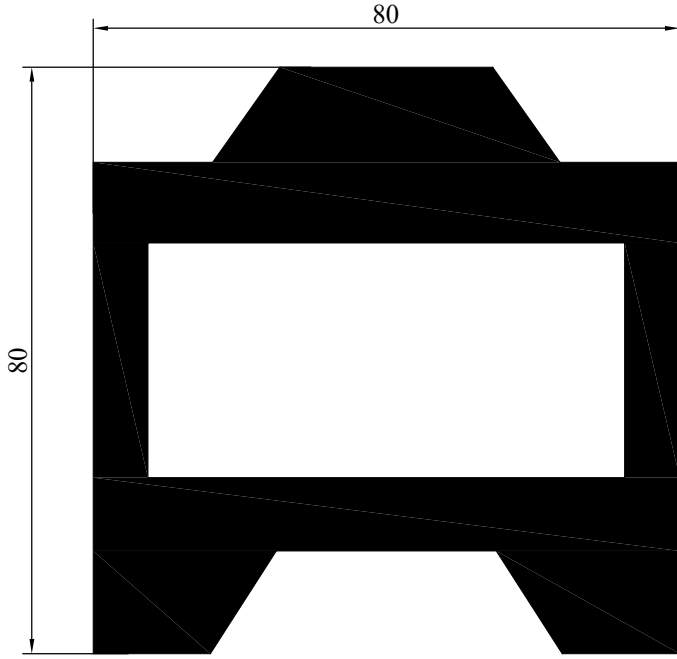

NO : 1777 AGIRLIK : 8.720 kg/m

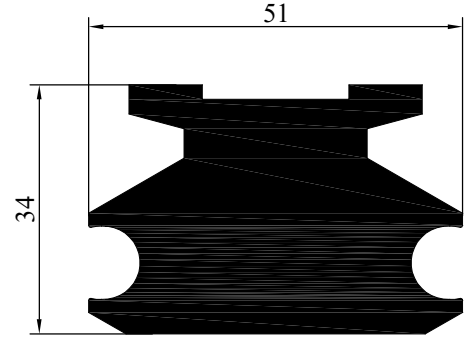

NO : 1158 AGIRLIK : 3.450 kg/m

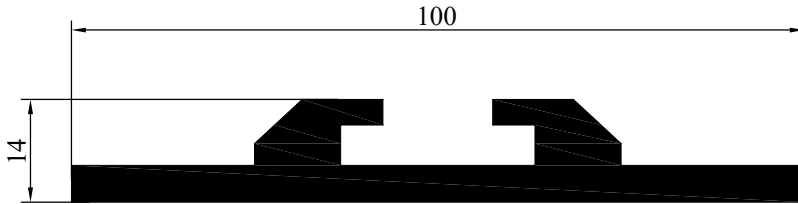

NO : 1920 AGIRLIK : 1.924 kg/m

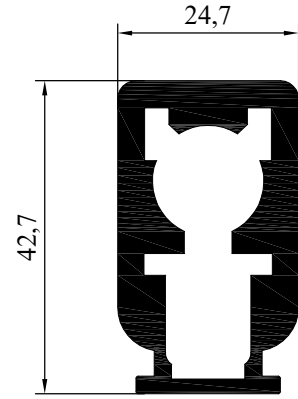

NO : 974 AGIRLIK : 1.441 kg/m

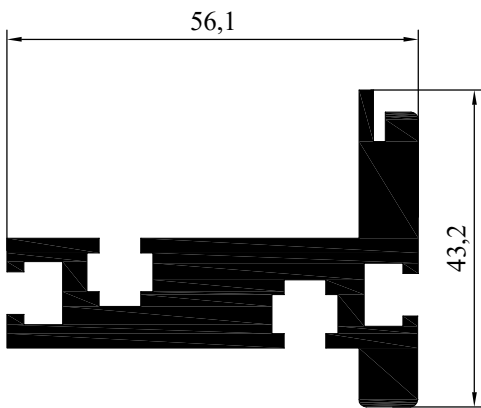

NO : 1990 AGIRLIK : 2.121 kg/m

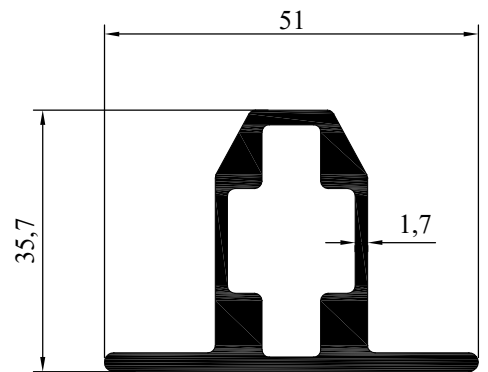

NO : 1925 AGIRLIK : 1.047 kg/m

MUHTELİF PROFİLLER

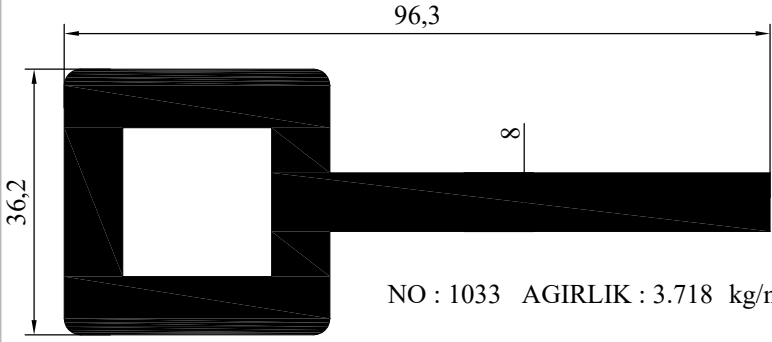

NO : 1033 AGIRLIK : 3.718 kg/m

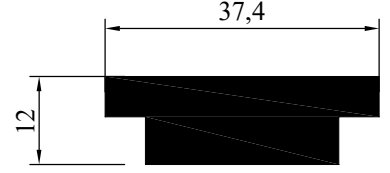

NO : 1094 AGIRLIK : 1.018 kg/m

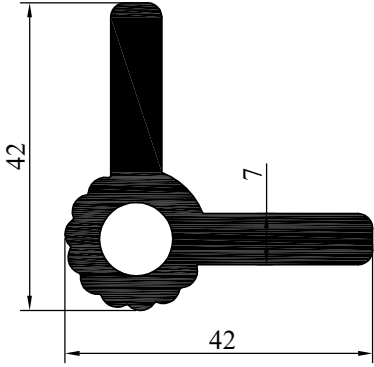

NO : 1031 AGIRLIK : 1.416 kg/m

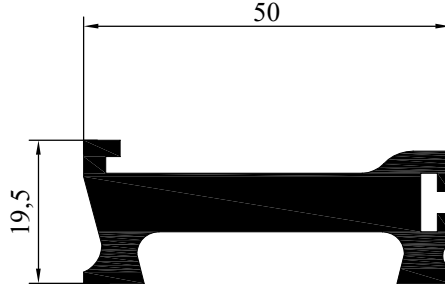

NO : 1254 AGIRLIK : 1.356 kg/m

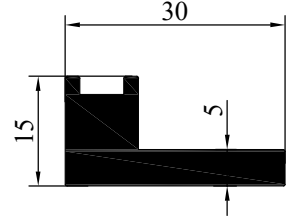

NO : 1003
AGIRLIK : 0.634 kg/m

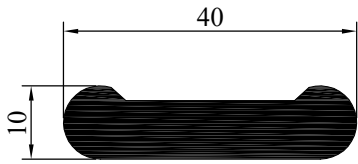

NO : 1636 AGIRLIK : 0.885 kg/m

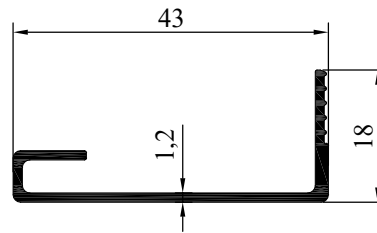

NO : 980 AGIRLIK : 0.262 kg/m

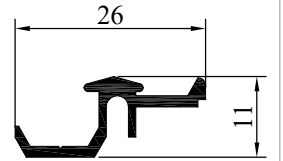

NO : 1392
AGIRLIK : 0.177 kg/m

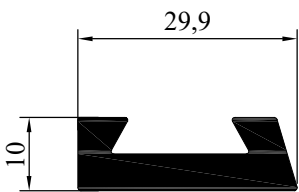

NO : 1029
AGIRLIK : 0.547 kg/m

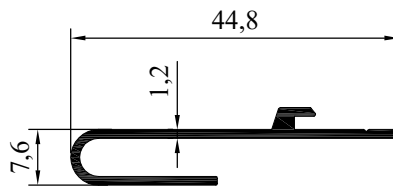

NO : 854
AGIRLIK : 0.247 kg/m

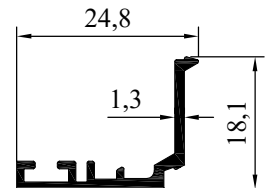

NO : 1391
AGIRLIK : 0.174 kg/m

MUHTELİF PROFİLLER

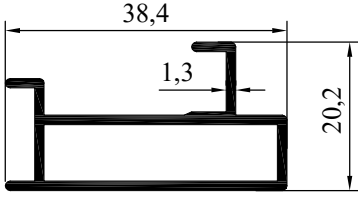

NO : 1291
AGIRLIK : 0.396 kg/m

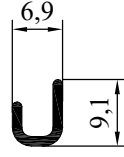

NO : 1419
AGIRLIK : 0.062 kg/m

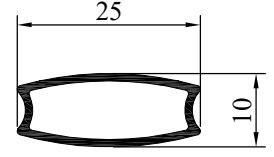

NO : 1012
AGIRLIK : 0.164 kg/m

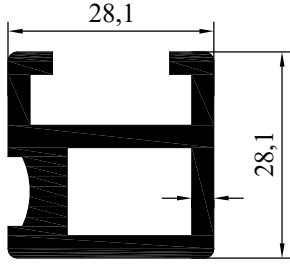

NO : 1549
AGIRLIK : 0.961 kg/m

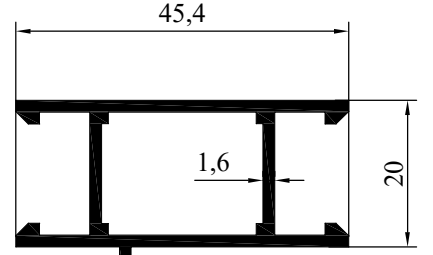

NO : 1780
AGIRLIK : 0.637 kg/m

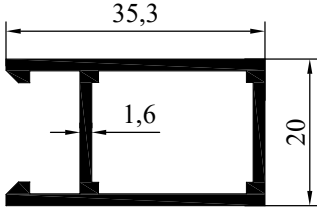

NO : 1654
AGIRLIK : 0.488 kg/m

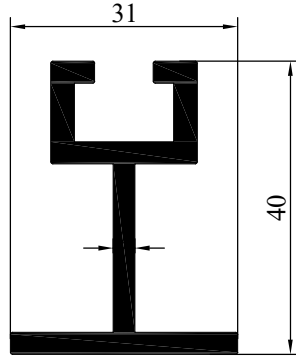

NO : 991
AGIRLIK : 0.836 kg/m

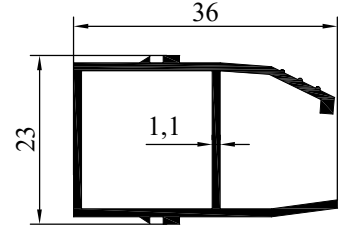

NO : 1853
AGIRLIK : 0.350 kg/m

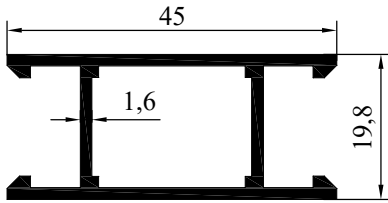

NO : 1653
AGIRLIK : 0.585 kg/m

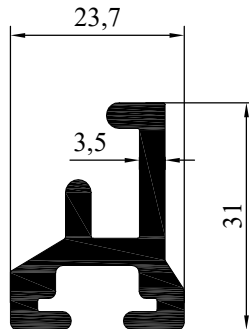

NO : 652
AGIRLIK : 0.734 kg/m

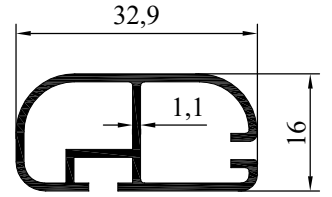

NO : 1822
AGIRLIK : 0.323 kg/m

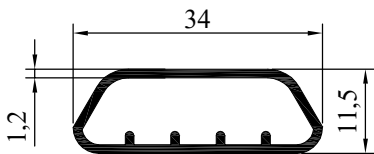

NO : 536
AGIRLIK : 0.269 kg/m

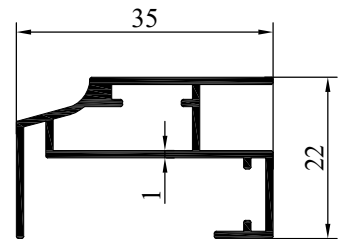

NO : 1008
AGIRLIK : 0.347 kg/m

MUHTELİF PROFİLLER

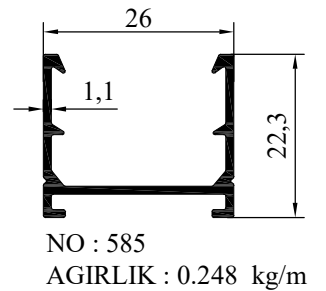
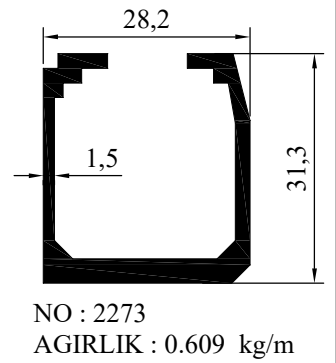
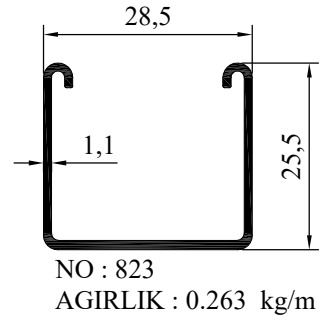
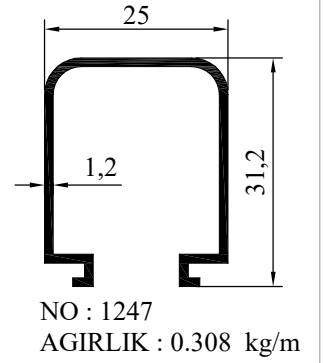
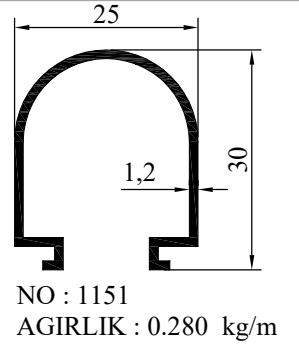
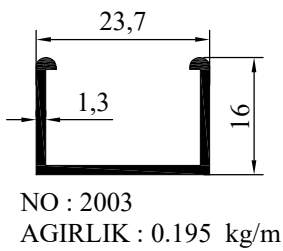
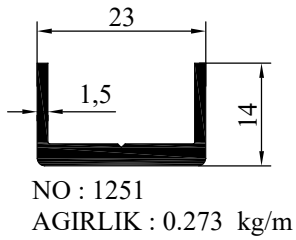
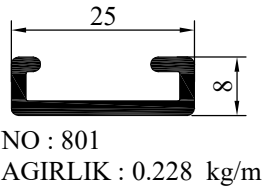
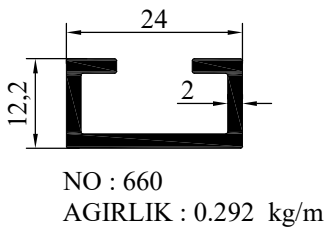
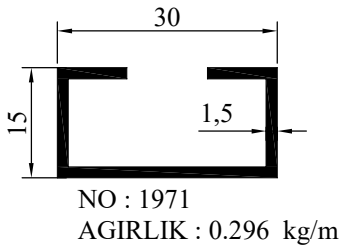
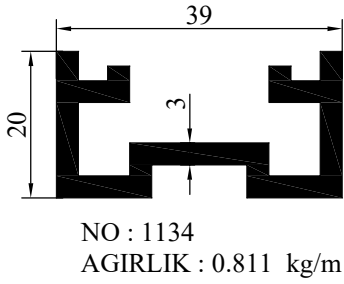
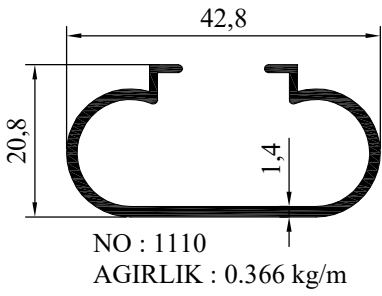
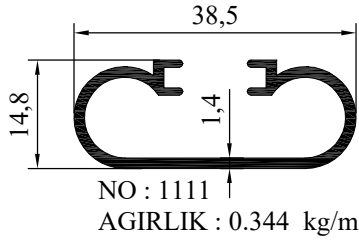

MUHTELİF PROFİLLER

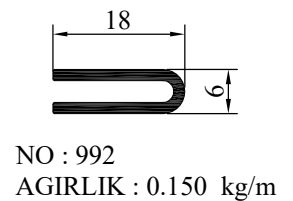
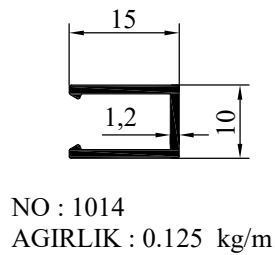
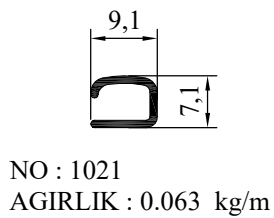
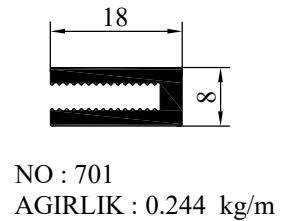
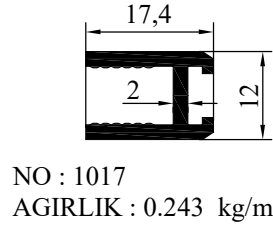
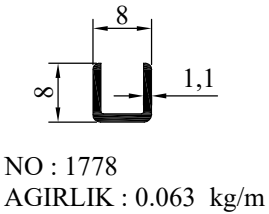
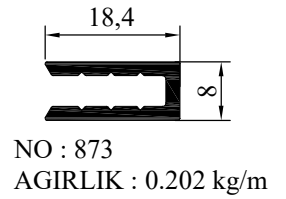
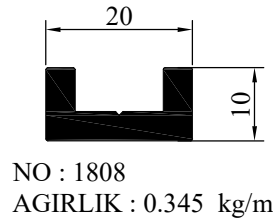
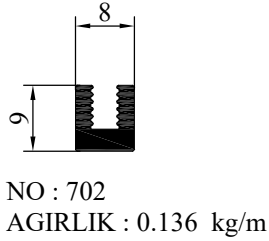
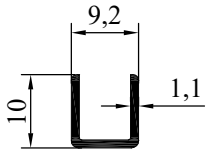
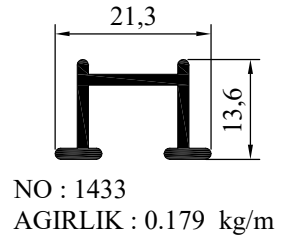
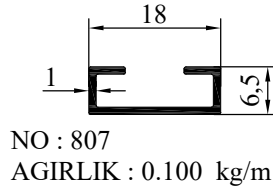
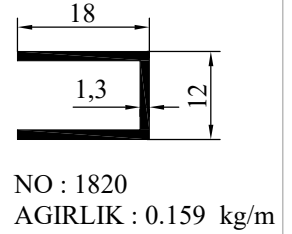
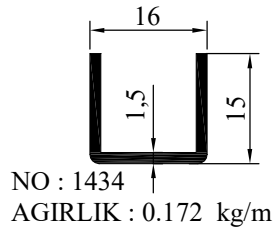
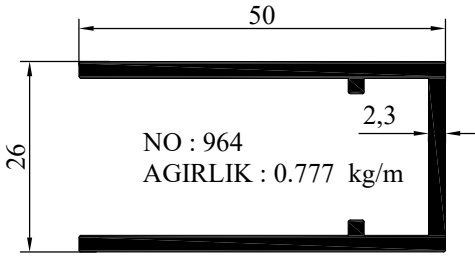
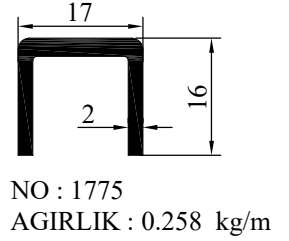
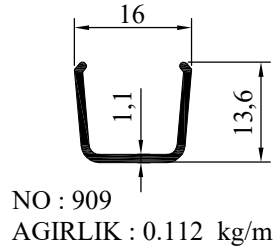
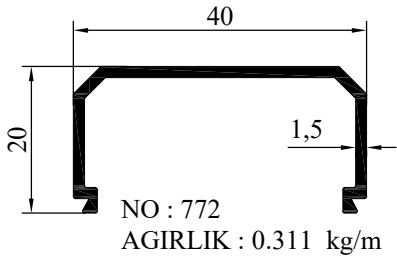
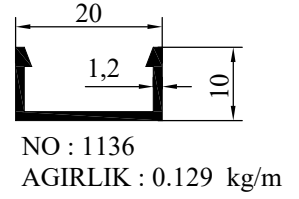
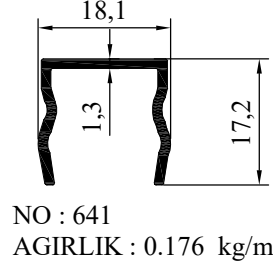
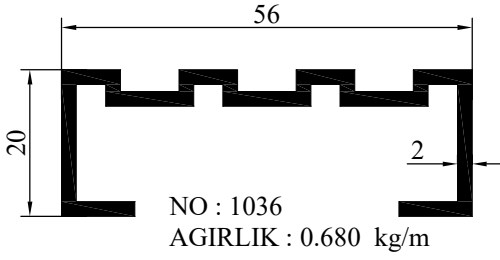

MUHTELİF PROFİLLER

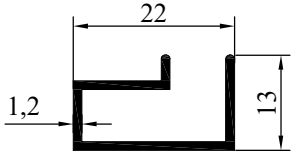

NO : 1746
AGIRLIK : 0.186 kg/m

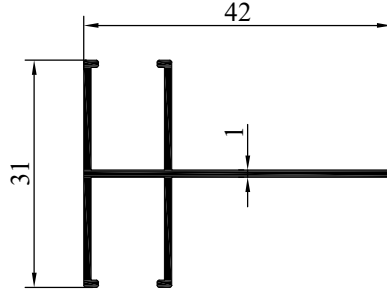

NO : 894
AGIRLIK : 0.285 kg/m

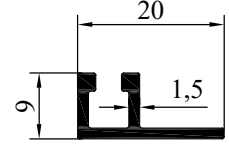

NO : 782
AGIRLIK : 0.154 kg/m

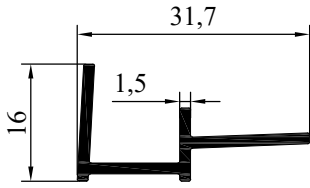

NO : 540
AGIRLIK : 0.220 kg/m

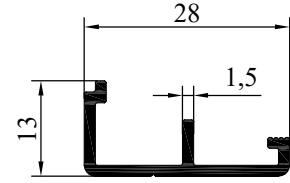

NO : 690
AGIRLIK : 0.208 kg/m

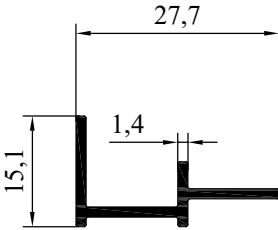

NO : 759
AGIRLIK : 0.184 kg/m

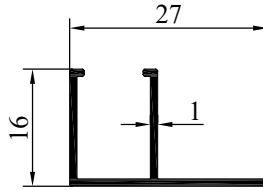

NO : 893
AGIRLIK : 0.159 kg/m

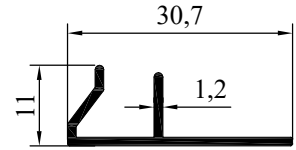

NO : 881
AGIRLIK : 0.163 kg/m

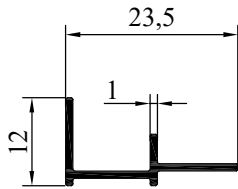

NO : 700
AGIRLIK : 0.109 kg/m

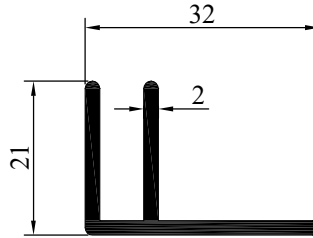

NO : 874
AGIRLIK : 0.374 kg/m

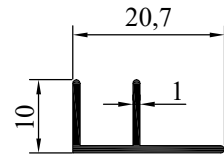

NO : 1745
AGIRLIK : 0.103 kg/m

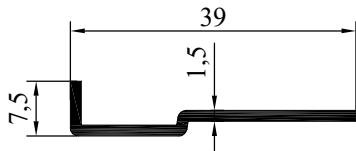

NO : 1088
AGIRLIK : 0.187 kg/m

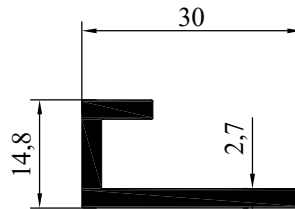

NO : 882
AGIRLIK : 0.357 kg/m

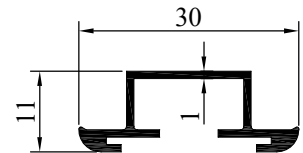

NO : 1303
AGIRLIK : 0.186 kg/m

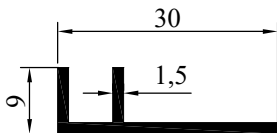

NO : 1032
AGIRLIK : 0.182 kg/m

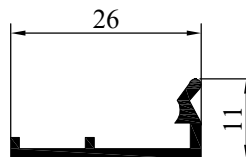

NO : 1750
AGIRLIK : 0.160 kg/m

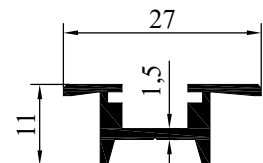

NO : 1152
AGIRLIK : 0.211 kg/m

MUHTELİF PROFİLLER

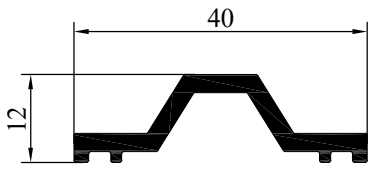

NO : 678
AGIRLIK : 0.358 kg/m

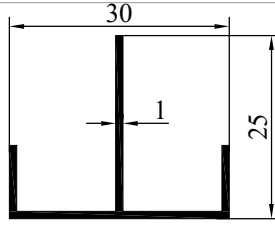

NO : 1055
AGIRLIK : 0.194 kg/m

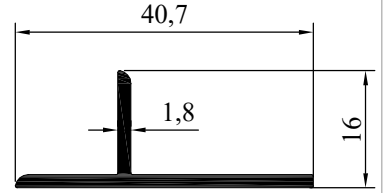

NO : 727
AGIRLIK : 0.262 kg/m

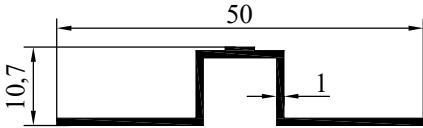

NO : 1448
AGIRLIK : 0.190 kg/m

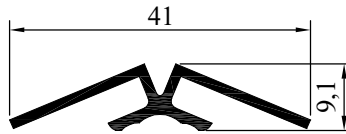

NO : 1217
AGIRLIK : 0.228 kg/m



NO : 1609
AGIRLIK : 0.396 kg/m



NO : 851
AGIRLIK : 0.252 kg/m

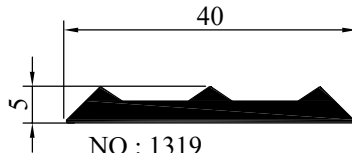

NO : 1319
AGIRLIK : 0.342 kg/m

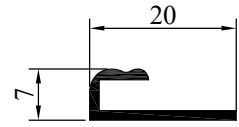

NO : 1216
AGIRLIK : 0.109 kg/m

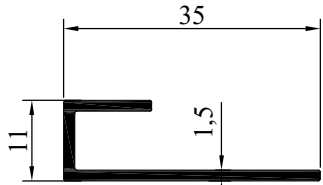

NO : 811
AGIRLIK : 0.222 kg/m



NO : 903
AGIRLIK : 0.247 kg/m

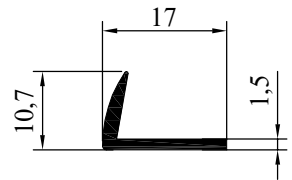

NO : 1591
AGIRLIK : 0.110 kg/m

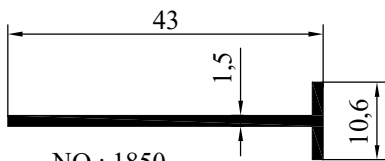

NO : 1850
AGIRLIK : 0.210 kg/m

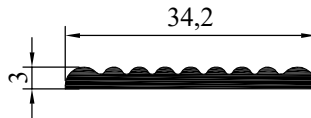

NO : 1041
AGIRLIK : 0.238 kg/m

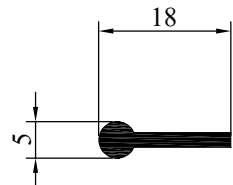

NO : 1813
AGIRLIK : 0.123 kg/m

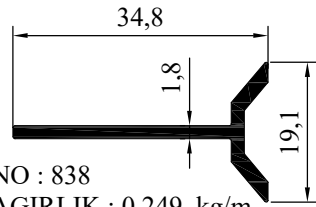

NO : 838
AGIRLIK : 0.249 kg/m

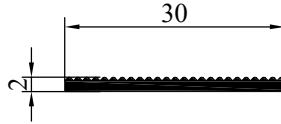

NO : 935
AGIRLIK : 0.145 kg/m

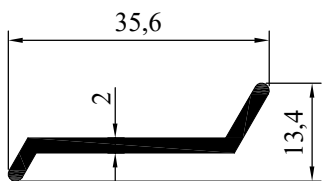

NO : 1221
AGIRLIK : 0.228 kg/m

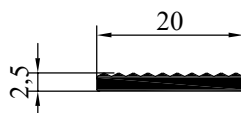

NO : 938
AGIRLIK : 0.122 kg/m

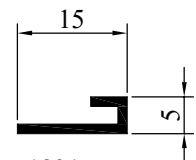

NO : 1821
AGIRLIK : 0.078 kg/m

MUHTELİF PROFİLLER

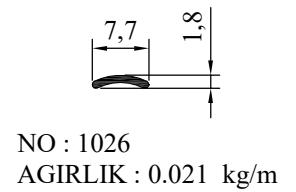
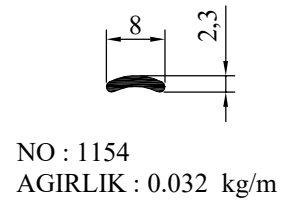
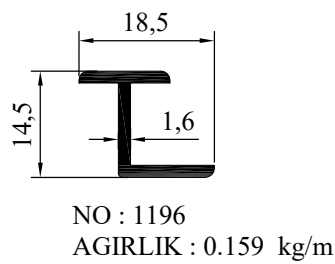
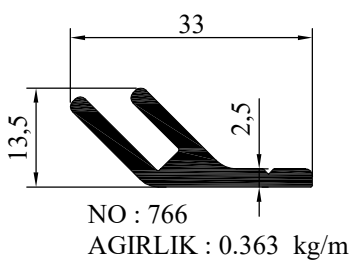
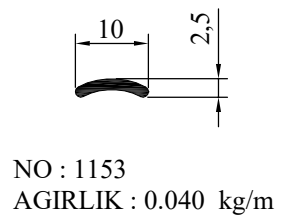
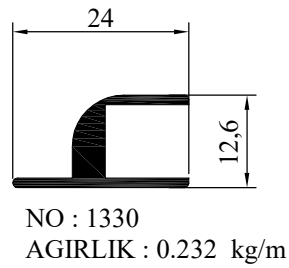
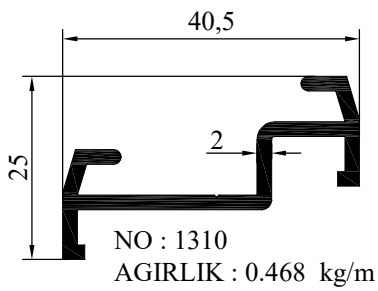
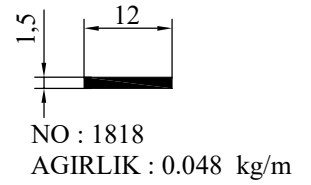
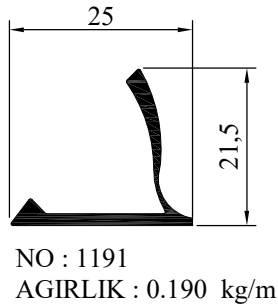
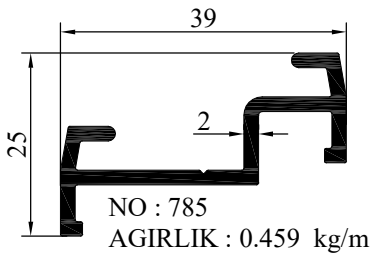
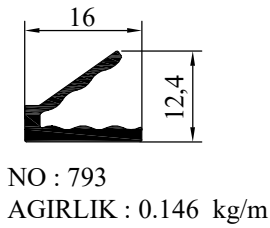
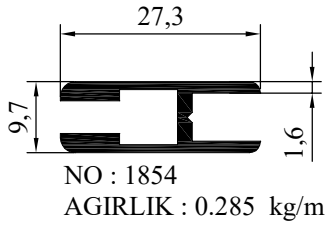
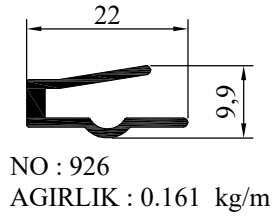
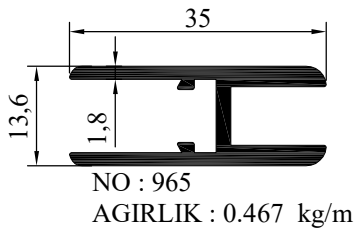
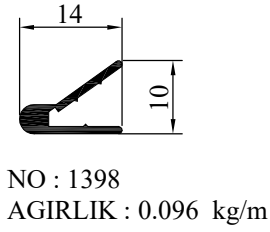
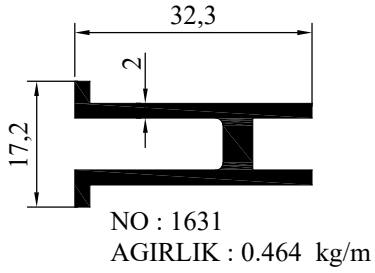

MUHTELİF PROFİLLER

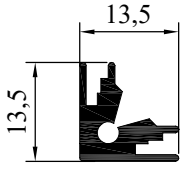

NO : 1117
AGIRLIK : 0.209 kg/m

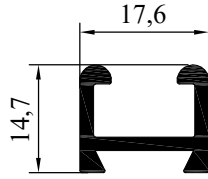

NO : 683
AGIRLIK : 0.257 kg/m

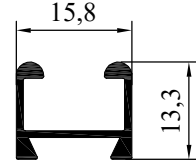

NO : 684
AGIRLIK : 0.151 kg/m

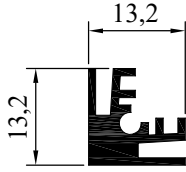

NO : 1227
AGIRLIK : 0.212 kg/m

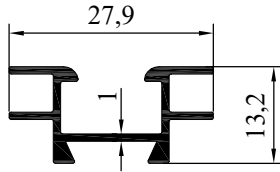

NO : 682
AGIRLIK : 0.216 kg/m

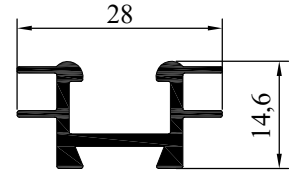

NO : 680
AGIRLIK : 0.293 kg/m

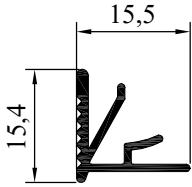

NO : 532
AGIRLIK : 0.142 kg/m

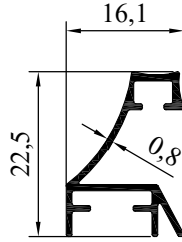

NO : 1080
AGIRLIK : 0.154 kg/m

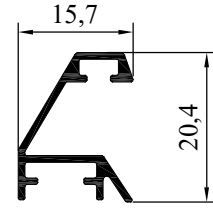

NO : 666
AGIRLIK : 0.157 kg/m

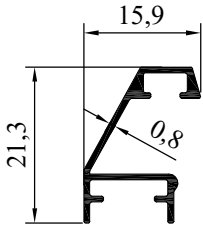

NO : 799
AGIRLIK : 0.137 kg/m

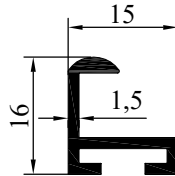

NO : 842
AGIRLIK : 0.180 kg/m

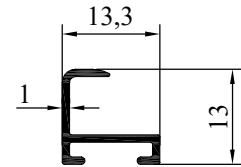

NO : 557
AGIRLIK : 0.099 kg/m

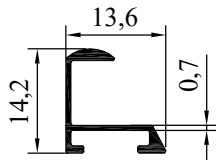

NO : 696
AGIRLIK : 0.089 kg/m

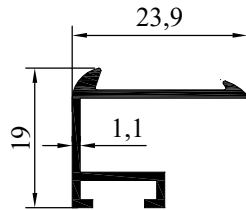

NO : 1083
AGIRLIK : 0.194 kg/m

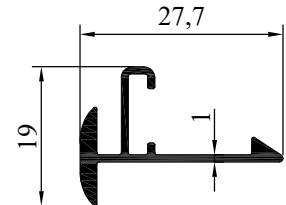

NO : 840
AGIRLIK : 0.201 kg/m

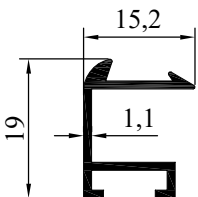

NO : 1082
AGIRLIK : 0.164 kg/m

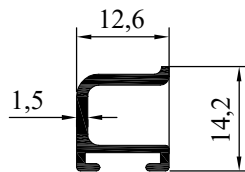

NO : 1147
AGIRLIK : 0.145 kg/m

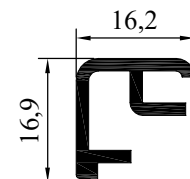

NO : 1289
AGIRLIK : 0.227 kg/m

MUHTELİF PROFİLLER

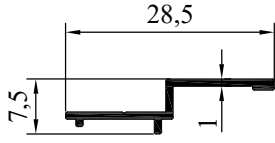

NO : 984
AGIRLIK : 0.100 kg/m

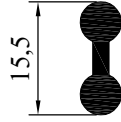

NO : 1142
AGIRLIK : 0.161 kg/m



NO : 1292
AGIRLIK : 0.057 kg/m

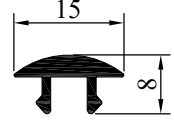

NO : 910
AGIRLIK : 0.123 kg/m

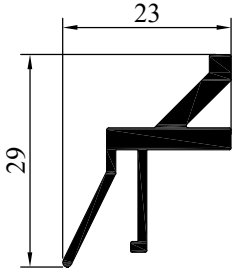

NO : 932
AGIRLIK : 0.346 kg/m

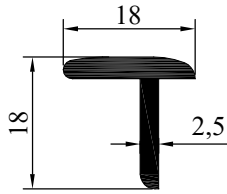

NO : 1301
AGIRLIK : 0.231 kg/m

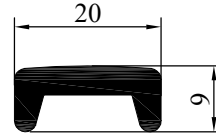

NO : 868
AGIRLIK : 0.290 kg/m

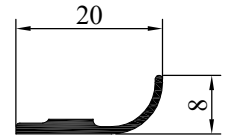

NO : 1020
AGIRLIK : 0.088 kg/m

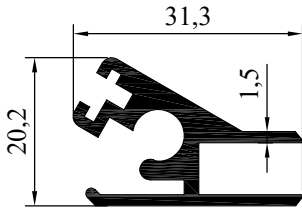

NO : 1835
AGIRLIK : 0.493 kg/m

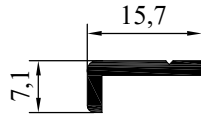

NO : 1038
AGIRLIK : 0.111 kg/m

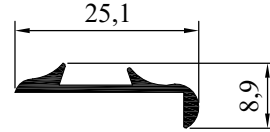

NO : 724
AGIRLIK : 0.115 kg/m

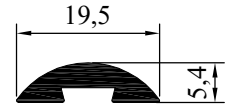

NO : 730
AGIRLIK : 0.167 kg/m

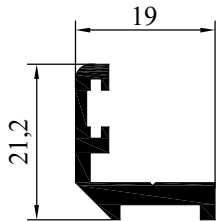

NO : 1195
AGIRLIK : 0.279 kg/m

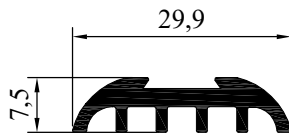

NO : 728
AGIRLIK : 0.301 kg/m

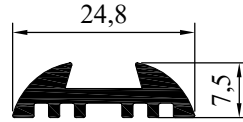

NO : 707
AGIRLIK : 0.250 kg/m

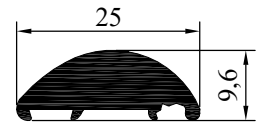

NO : 735
AGIRLIK : 0.406 kg/m

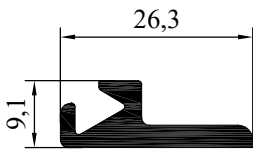

NO : 1279
AGIRLIK : 0.292 kg/m

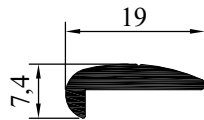

NO : 783
AGIRLIK : 0.166 kg/m

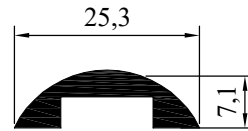

NO : 1298
AGIRLIK : 0.242 kg/m

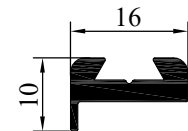

NO : 765
AGIRLIK : 0.200 kg/m

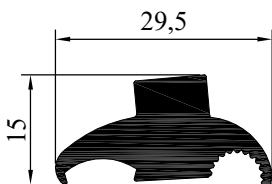

NO : 736
AGIRLIK : 0.595 kg/m

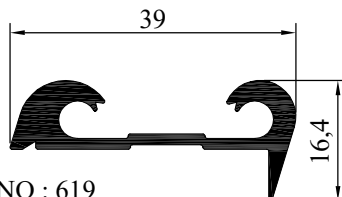

NO : 619
AGIRLIK : 0.423 kg/m

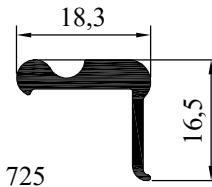

NO : 725
AGIRLIK : 0.214 kg/m

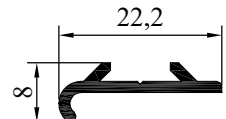

NO : 1022
AGIRLIK : 0.129 kg/m

MUHTELİF PROFİLLER

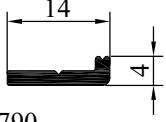

NO : 790
AGIRLIK : 0.084 kg/m

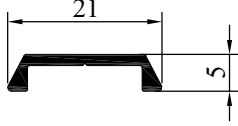

NO : 738
AGIRLIK : 0.109 kg/m

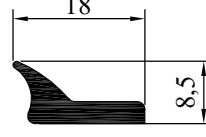

NO : 1040
AGIRLIK : 0.176 kg/m

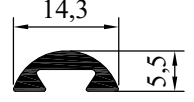

NO : 950
AGIRLIK : 0.104 kg/m

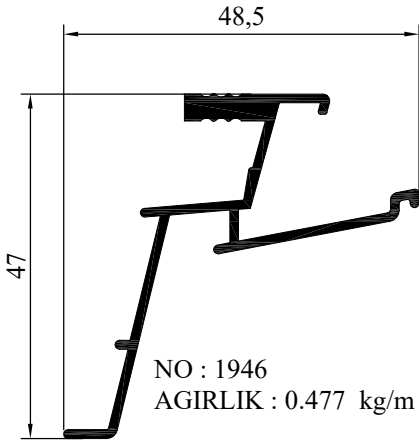

NO : 1946
AGIRLIK : 0.477 kg/m

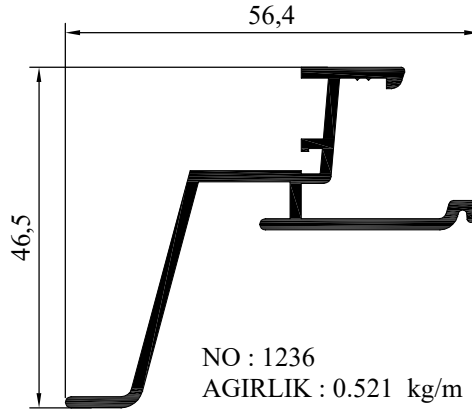

NO : 1236
AGIRLIK : 0.521 kg/m

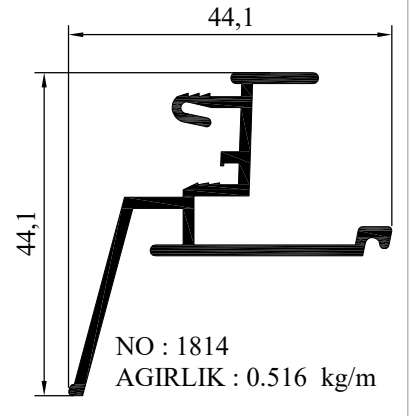

NO : 1814
AGIRLIK : 0.516 kg/m

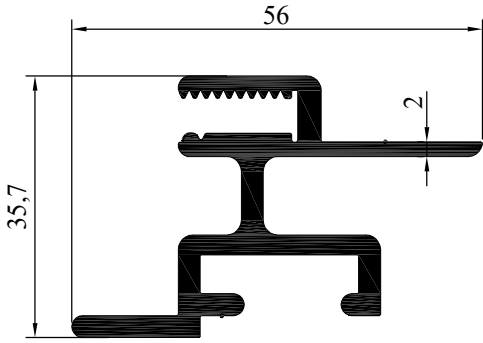

NO : 651
AGIRLIK : 1.082 kg/m

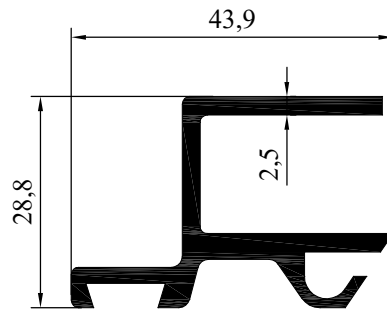

NO : 1810
AGIRLIK : 0.763 kg/m

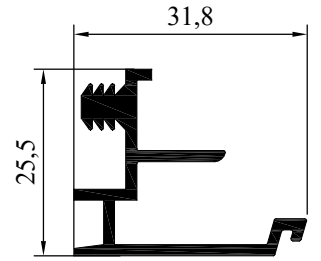

NO : 1224
AGIRLIK : 0.406 kg/m

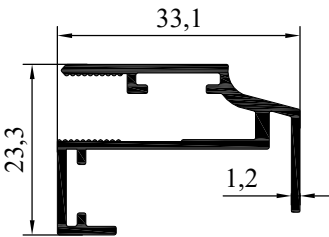

NO : 774
AGIRLIK : 0.378 kg/m

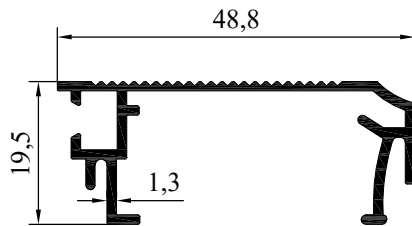

NO : 843
AGIRLIK : 0.387 kg/m

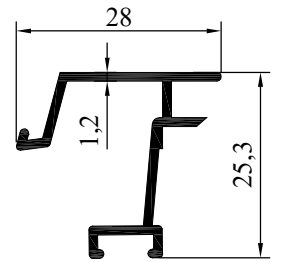

NO : 1574
AGIRLIK : 0.258 kg/m

MUHTELİF PROFİLLER

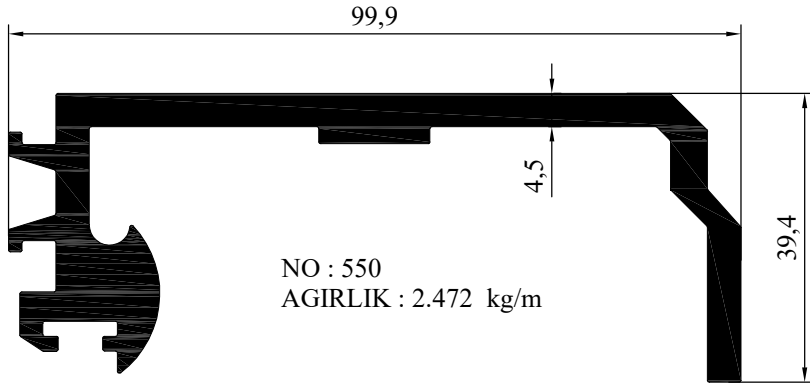

NO : 550
AGIRLIK : 2.472 kg/m

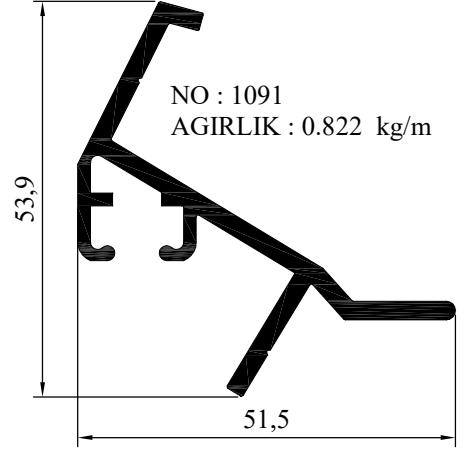

NO : 1091
AGIRLIK : 0.822 kg/m

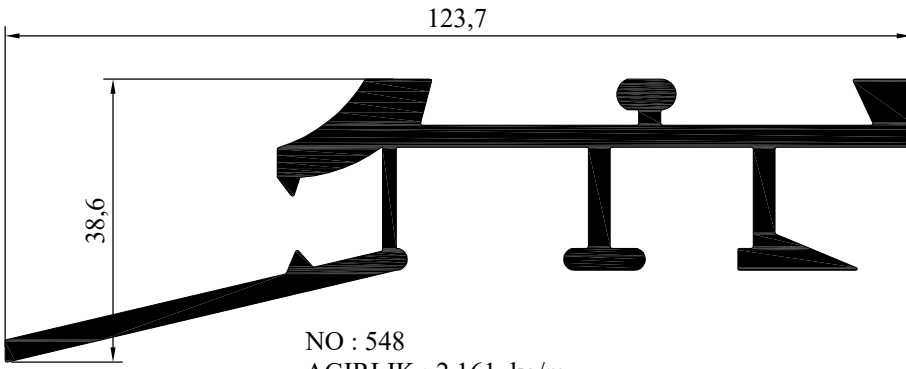

NO : 548
AGIRLIK : 2.161 kg/m

NO : 1575
AGIRLIK : 0.346 kg/m

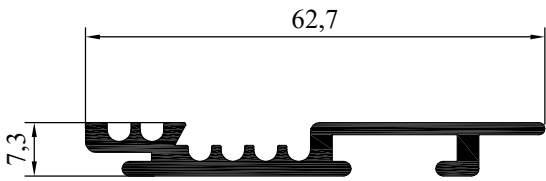

NO : 971
AGIRLIK : 0.557 kg/m

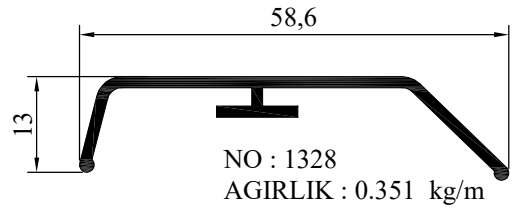

NO : 1328
AGIRLIK : 0.351 kg/m

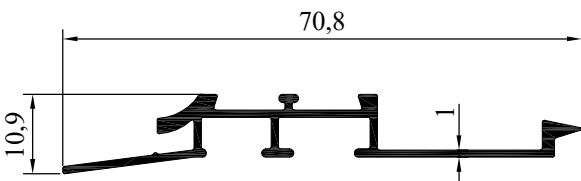

NO : 547
AGIRLIK : 0.343 kg/m

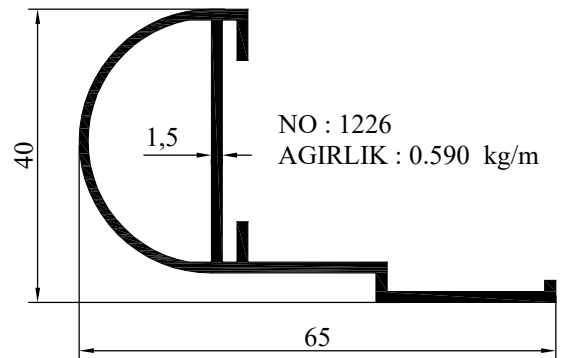

NO : 1226
AGIRLIK : 0.590 kg/m

MUHTELİF PROFİLLER

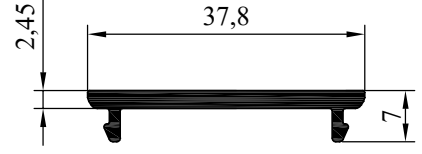
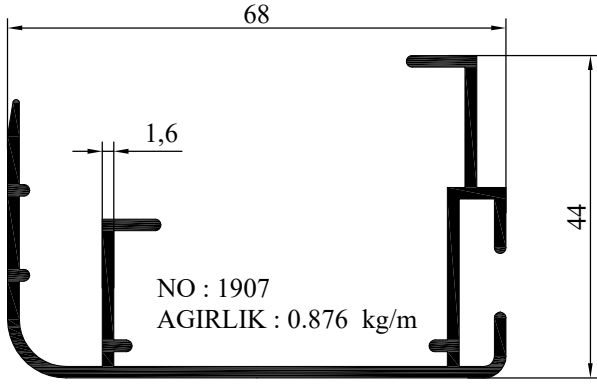

NO : 3242 AGIRLIK : 0.291 kg/m

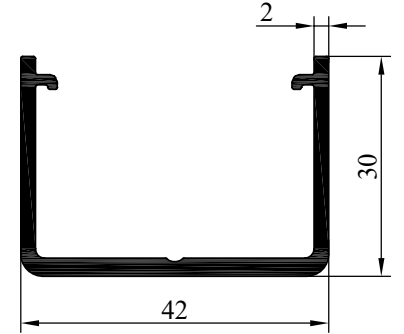
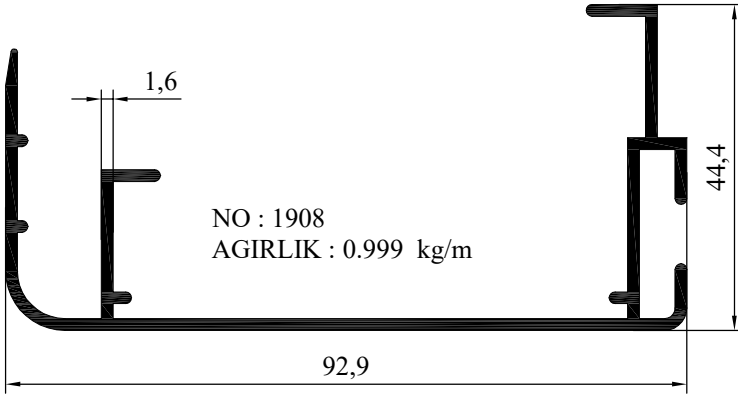

NO : 3241 AGIRLIK : 0.595 kg/m

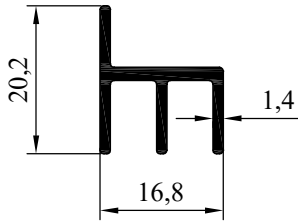

NO : 2669
AGIRLIK : 0.226 kg/m

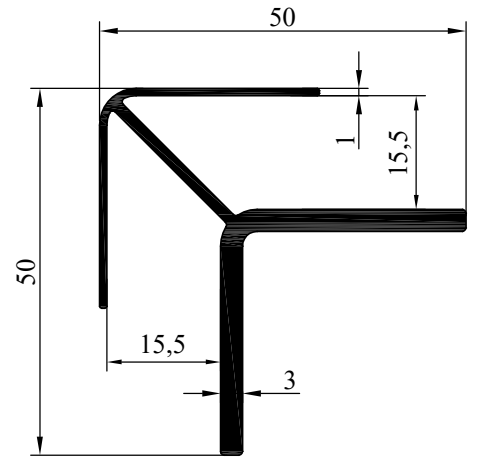
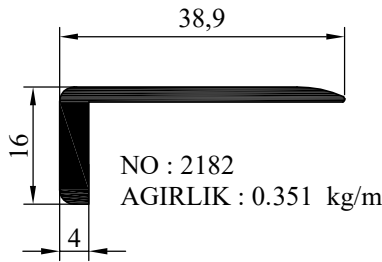

NO : 2608
AGIRLIK : 0.750 kg/m

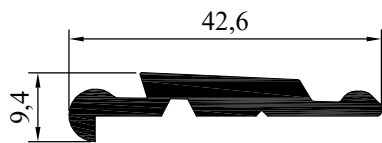

NO : 1411 AGIRLIK : 0.474 kg/m

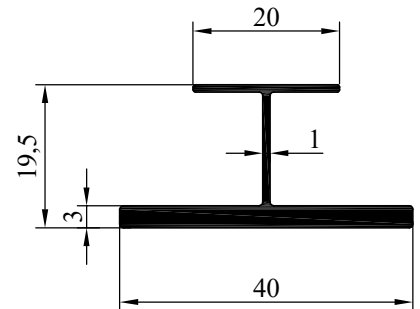

NO : 2609
AGIRLIK : 0.420 kg/m

MUHTELİF PROFİLLER

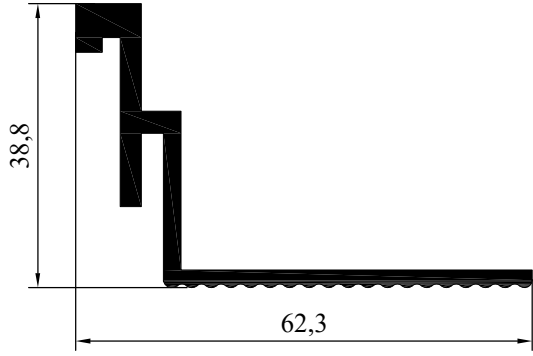

NO : 1667 AGIRLIK : 0.771 kg/m

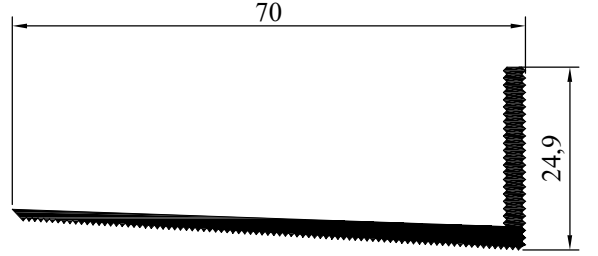

NO : 1178 AGIRLIK : 0.536 kg/m

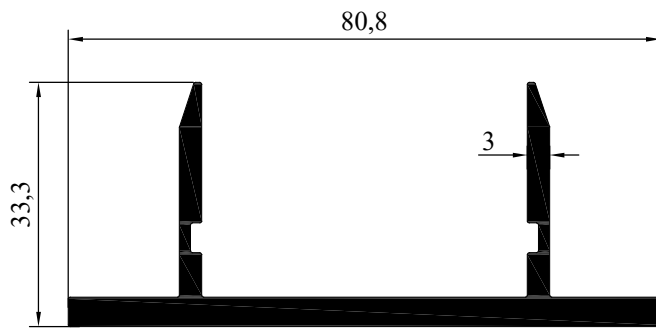

NO : 1339 AGIRLIK : 1.294 kg/m

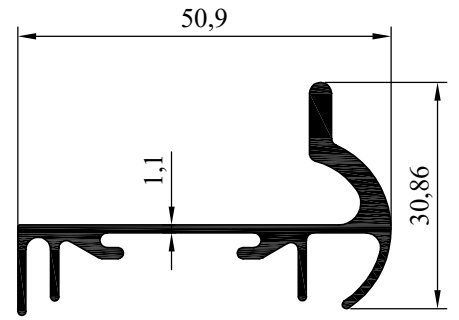

NO : 7593 AGIRLIK : 0.574 kg/m

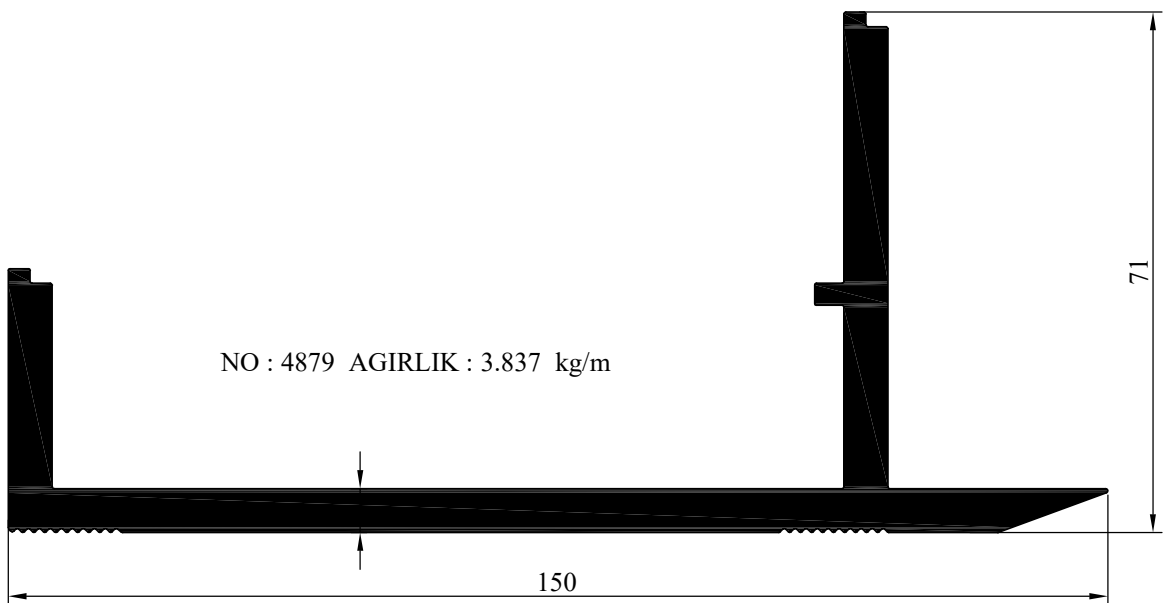

NO : 4879 AGIRLIK : 3.837 kg/m

MUHTELİF PROFİLLER

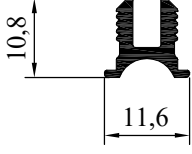

NO : 3397
AGIRLIK : 0.131 kg/m

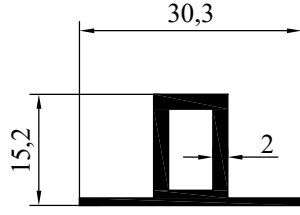

NO : 1138
AGIRLIK : 0.286 kg/m

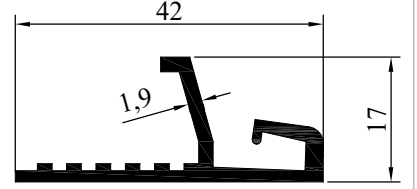

NO : 1186
AGIRLIK : 0.382 kg/m

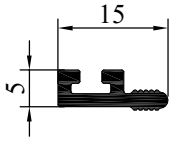

NO : 607
AGIRLIK : 0.123 kg/m

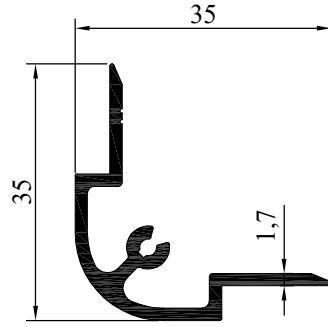

NO : 1290
AGIRLIK : 0.405 kg/m

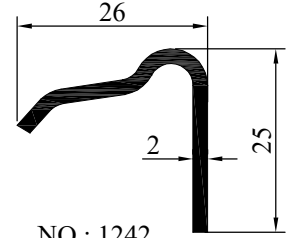

NO : 1242
AGIRLIK : 0.296 kg/m

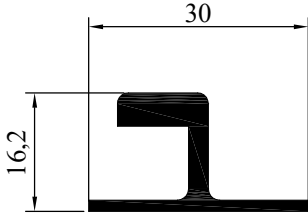

NO : 1610
AGIRLIK : 0.350 kg/m

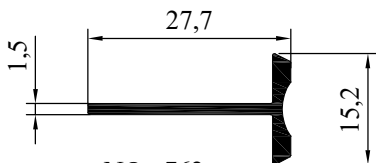

NO : 762
AGIRLIK : 0.181 kg/m

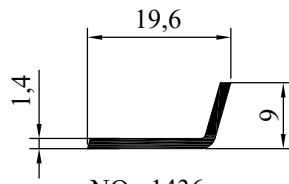

NO : 1436
AGIRLIK : 0.093 kg/m

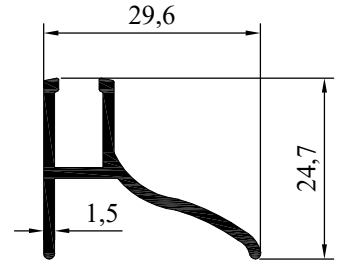

NO : 1004
AGIRLIK : 0.283 kg/m

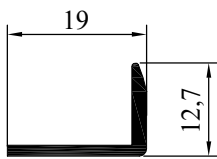

NO : 1039
AGIRLIK : 0.131 kg/m

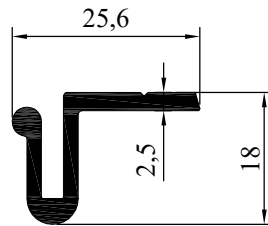

NO : 778
AGIRLIK : 0.322 kg/m

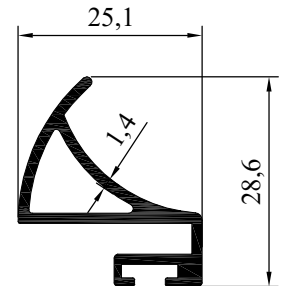

NO : 988
AGIRLIK : 0.360 kg/m

MUHTELİF PROFİLLER

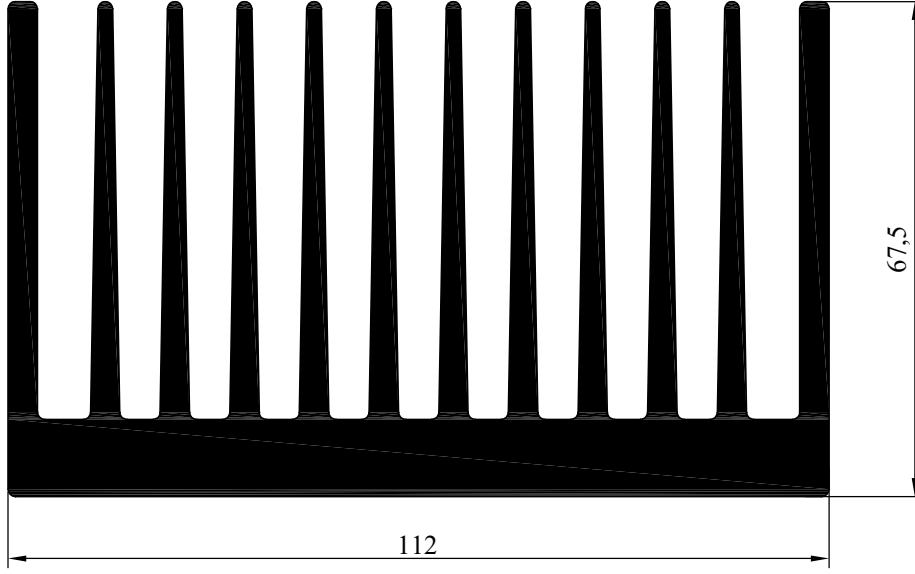

NO:7774 AĞIRLIK: 9021 gr/m

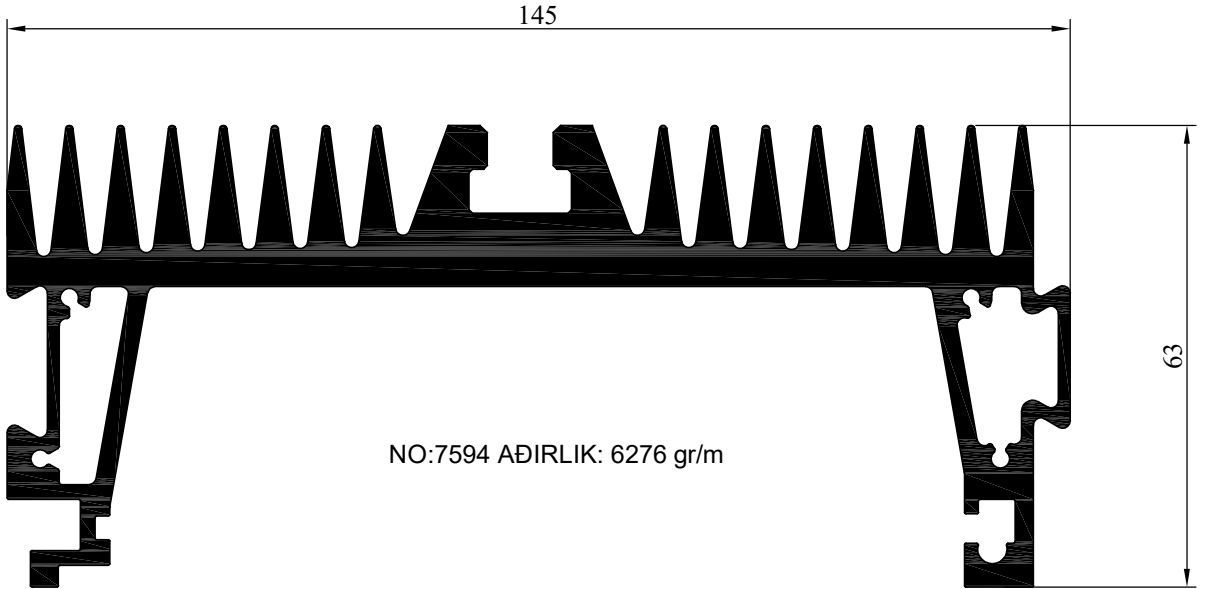

NO:7594 AĞIRLIK: 6276 gr/m

MUHTELİF PROFİLLER

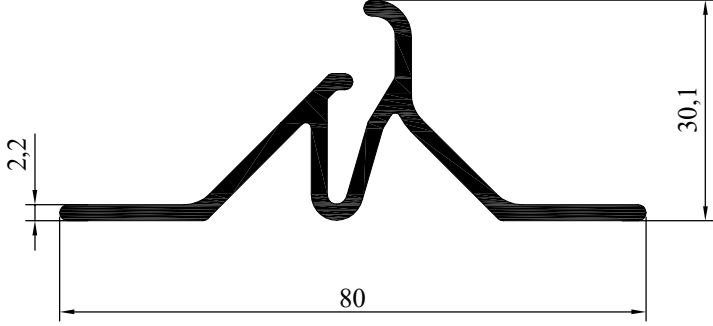

NO : 3011 AGIRLIK : 0.822 kg/m

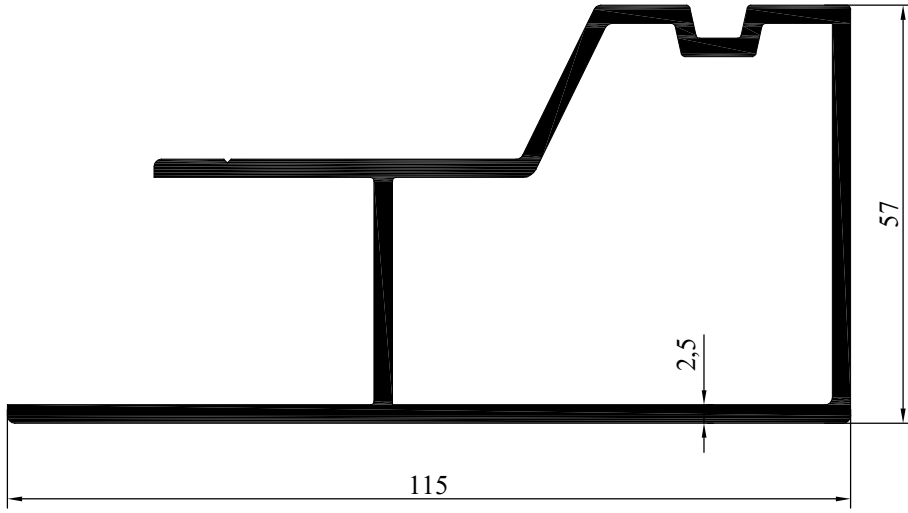

NO : 2908 AGIRLIK : 2.120 kg/m

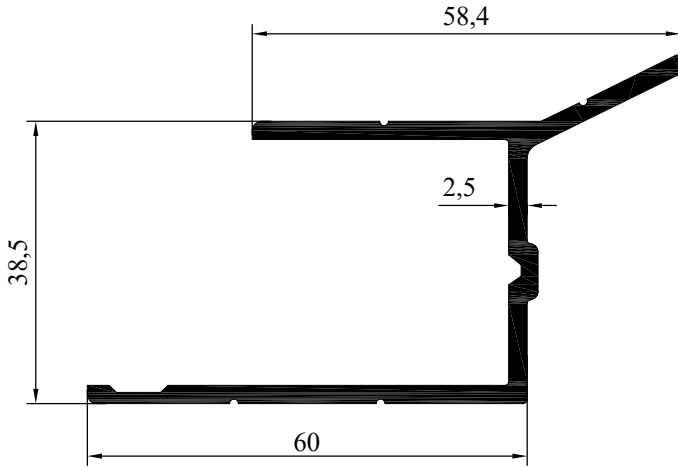

NO : 2909
AGIRLIK : 1.035 kg/m

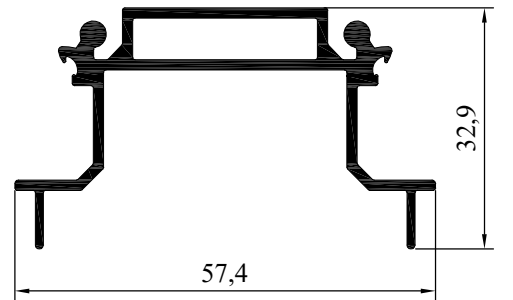

NO : 3178 AGIRLIK : 0.685 kg/m