

OB1-120 - STRUKTUREL OFIS BOLME

OB1-120 - VISION PARTITION

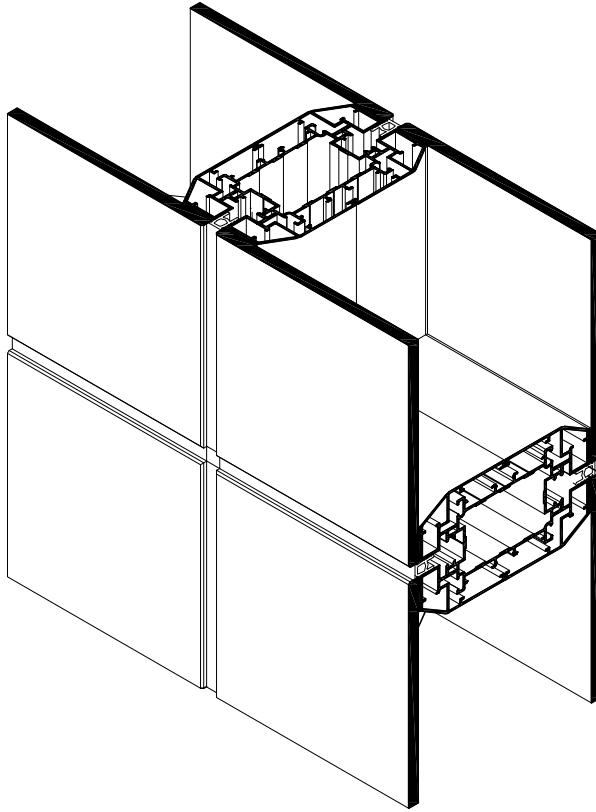

alutech
part

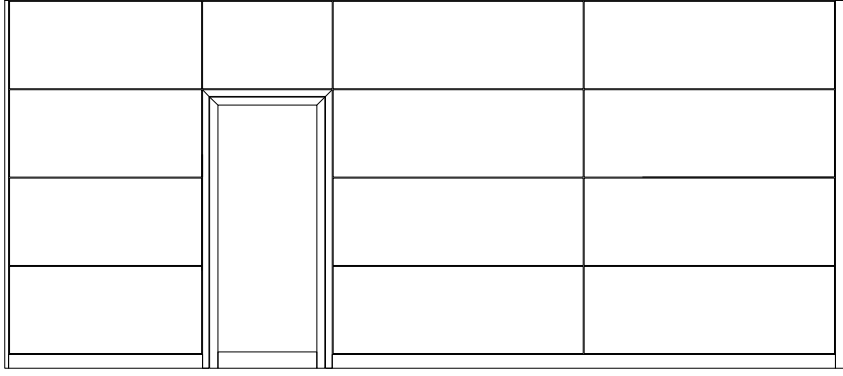
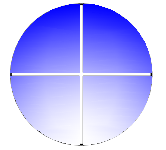

OB1-120

OB1 - Strüktürel Ofis Bölme

OB1- Vision Partition

Alaşım Özellikleri

Alloy Properties

EN AW 6060 (AlMgSi0,5 F22) EN AW 6063(AlMg0,7Si F22)

Üretim ve Mekanik Standartları

Production and Mecanical Standards

EN 12020-2 - EN 755-9 - EN 755-2

OB1-120
OB1 - STRUKTUREL OFIS BOLME
OB1- VISION PARTITION





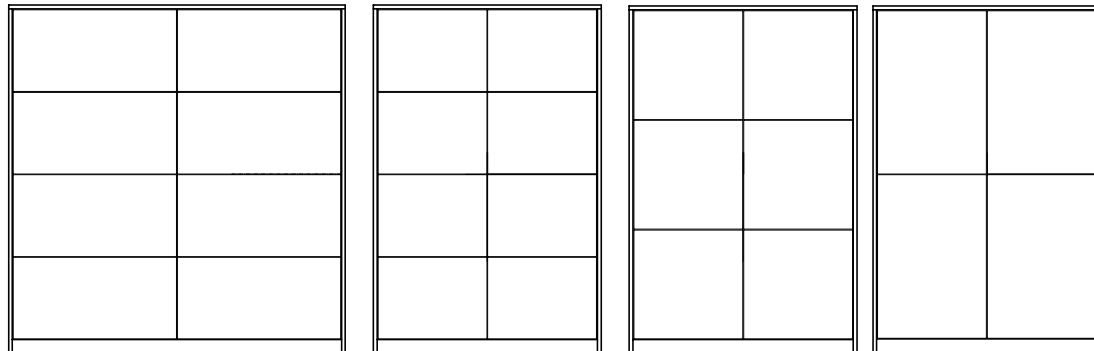
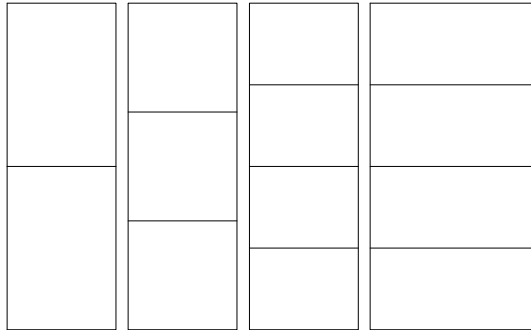
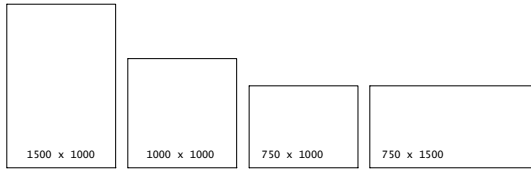
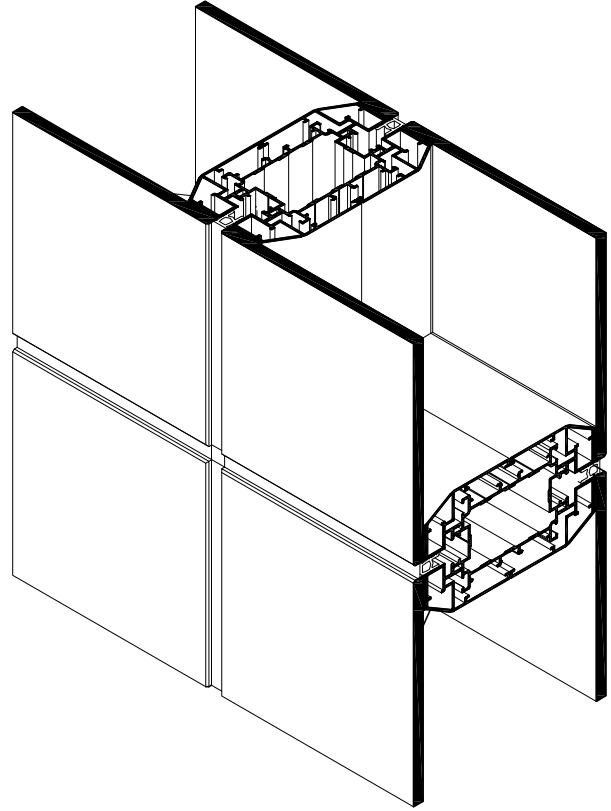
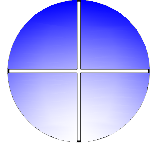





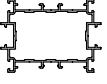

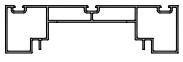

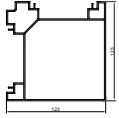

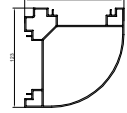
STANDART PANEL TIPLERİ
STANDARD PANEL TYPES

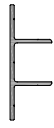
alutech
part

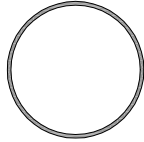
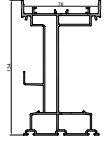
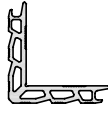
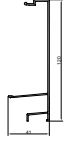

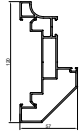
OB1 - 120
STRÜKTÜREL BÖLME
VISION PARTITION

ÜRÜN TEKNİK ÖZELLİKLERİ
PRODUCT'S TECHNICAL FEATURES

PROFİL KESİTİ PROFILE VIEW	PROFİL NO PROFILE NO	PROFİL AÇIKLAMASI PROFILE DESCRIPTION	gr/m	PROFİL KESİTİ PROFILE VIEW	PROFİL NO PROFILE NO	PROFİL AÇIKLAMASI PROFILE DESCRIPTION	gr/m
	OB1-101 (69.5 - 50.7)	TAŞIYICI PROFİLİ CARRIER PROFILE	1116		OB1-112 (29.6 - 23.1)	PANEL MONTAJ PROFİLİ PANEL INSTALLATION PROFILE	255
	OB1-102 (120 - 32.9)	KASA PROFİLİ FRAME	1331		OB1-201 (42.6 - 11.7)	ASKI TUTUCU PROFİLİ STRAP HOLDER PROFILE	454
 ölçeksiz not to scale	OB1-103 (123.3 - 123.3)	KÖŞE DÖNÜŞ PROFİLİ CASEMENT PROFILE	2655		OB1-202 (36.1 - 49.9)	RAF ASKI PROFİLİ RACK HANGER PROFILE	666
 ölçeksiz not to scale	OB1-104 (123.3 - 123.3)	KÖŞE DÖNÜŞ PROFİLİ CASEMENT PROFILE	2499		OB1-203 (36.1 - 49.9)	DOLAP ASKI PROFİLİ HANGING CABINET PROFILE	798
 İşaretti profil için satış temsilcinizden bilgi alınız.	OB1-105 (120.5 - 36.6)	KÖŞE DÖNÜŞ PROFİLİ CASEMENT PROFILE	1148		OB1-204 (80 - 29)	BAĞLANTI PROFİLİ CONNECTION PROFILE	963
 İşaretti profil için satış temsilcinizden bilgi alınız.	OB1-106 (119.4 - 23.6)	KÖŞE DÖNÜŞ PROFİLİ CASEMENT PROFILE	792		OB1-114 (95)	KÖŞE DÖNÜŞ PROFİLİ CASEMENT PROFILE	1969
 ölçeksiz not to scale	OB1-107 (133.9 - 78.4)	KABLO KANAL PROFİLİ CABLE CHANNEL PROFILE	2636		SC0308 (70 - 70)	KÖŞE BİRLEŞTİRME PROFİLİ CORNER CLEATS PROFILE	2392
 ölçeksiz not to scale	OB1-108 (120.4 - 40.9)	SÜPÜRGELİK PROFİLİ KICKING PROFILE	836		OB1-205 (50 - 50)	KÖŞE BİRLEŞTİRME PROFİLİ CORNER CLEATS PROFILE	789
 ölçeksiz not to scale	OB1-109 (120 - 57)	KAPI KASA PROFİLİ DOOR FRAME PROFILE	1689		OB1-206 (40 - 40)	KÖŞE BİRLEŞTİRME PROFİLİ CORNER CLEATS PROFILE	319
	OB1-110 (52.3 - 28.6)	KASET PROFİLİ CASEMENT PROFILE	487	 İşaretti profil için satış temsilcinizden bilgi alınız.	OB1-113 (30 - 05)	KAPAK PROFİLİ COVER PROFILE	57
	OB1-111 (29.6 - 15.1)	PANEL MONTAJ PROFİLİ PANEL INSTALLATION PROFILE	222				

Profil değerleri teoriktir. Ağırlık olarak testimde yapılan tartım geçerlidir.
Profil imatları TS EN 12020-2 ve TS EN 755-9 toleransı,
Moment değerleri EN 14024'e göre hesaplanmıştır.

Profile values are theoretical pre-shipment weight will be valid.
The tolerances of Profile manufacturing are calculated according to EN 12020-2
and TS EN 755-9; moment values are calculated according to EN 14024.

OB1 - 120
STRÜKTÜREL BÖLME
VISION PARTITION

ÜRÜN TEKNİK ÖZELLİKLERİ
PRODUCT'S TECHNICAL FEATURES

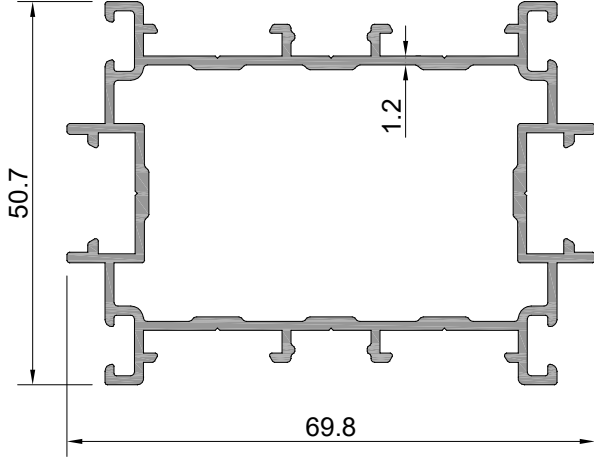

Profil No : OB1-101
Ağırlık : 1116 gr/m

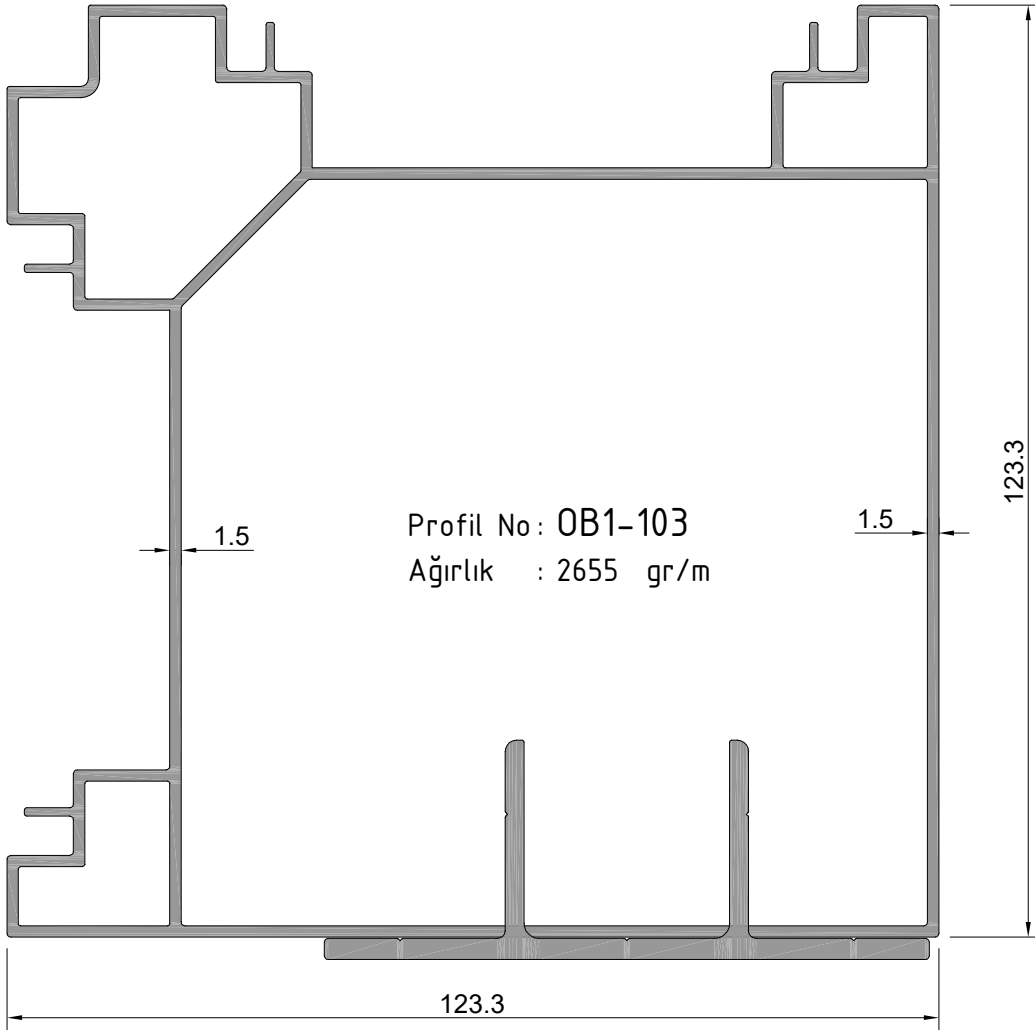

Profil No : OB1-103
Ağırlık : 2655 gr/m

OB1 - 120
STRÜKTÜREL BÖLME
VISION PARTITION

ÜRÜN TEKNİK ÖZELLİKLERİ
PRODUCT'S TECHNICAL FEATURES

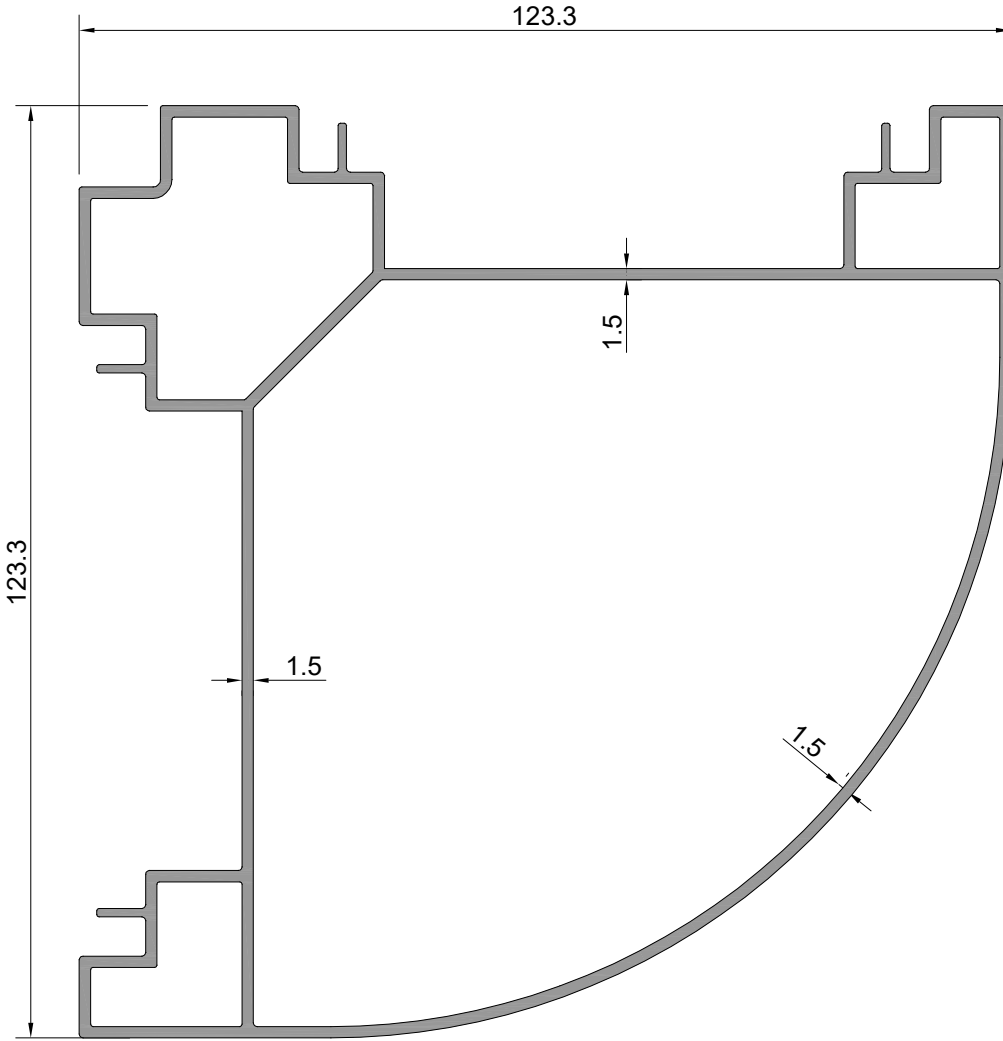

Profil No : OB1-104 

Ağırlık : 2499 gr/m

 İşaretili profil için satış temsilcinizden bilgi alın.

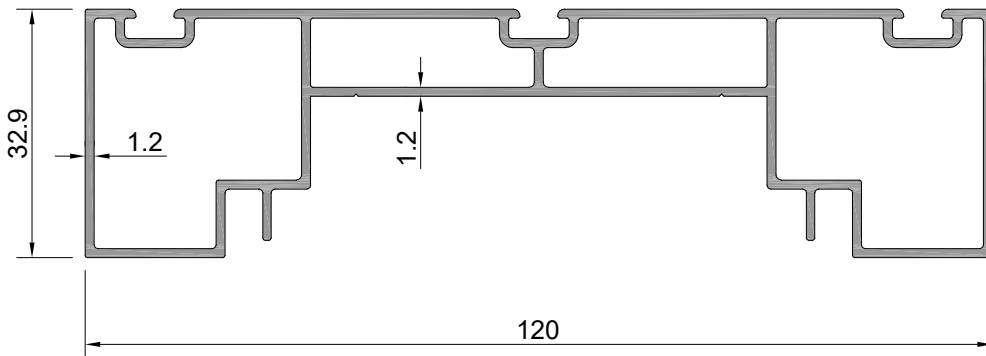



Profil No : OB1-102

Ağırlık : 1331 gr/m

OB1 - 120
STRÜKTÜREL BÖLME
VISION PARTITION

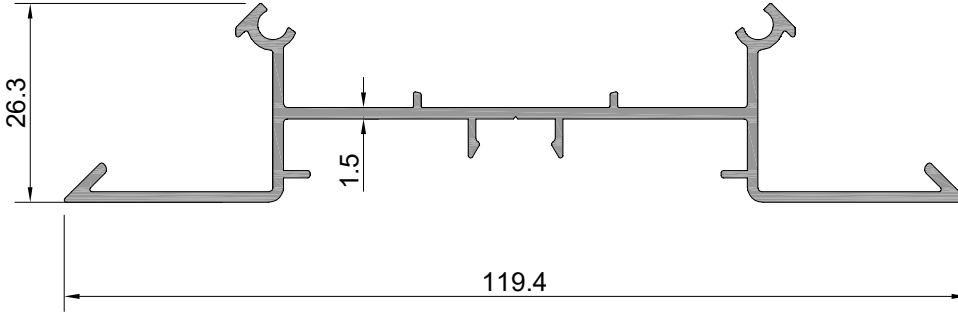
ÜRÜN TEKNİK ÖZELLİKLERİ
PRODUCT'S TECHNICAL FEATURES



Profil No : OB1-106 

Ağırlık : 792 gr/m

 İşaretti profil için satış temsilcinizden bilgi alınız.

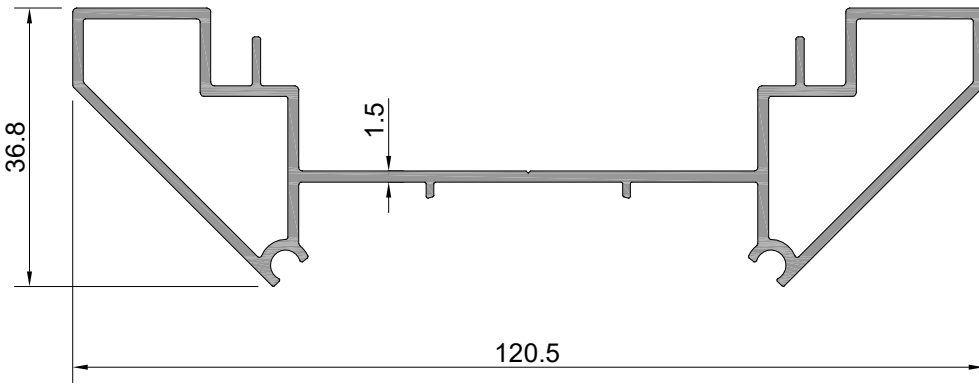

Profil No : OB1-105 

Ağırlık : 1148 gr/m

 İşaretti profil için satış temsilcinizden bilgi alınız.

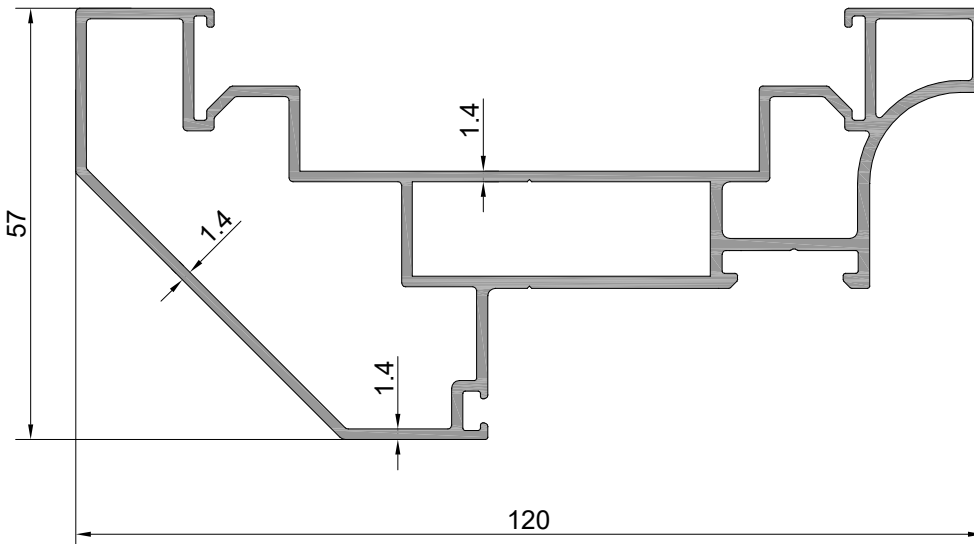

Profil No : OB1-109

Ağırlık : 1689 gr/m



OB1 - 120
STRÜKTÜREL BÖLME
VISION PARTITION

ÜRÜN TEKNİK ÖZELLİKLERİ
PRODUCT'S TECHNICAL FEATURES

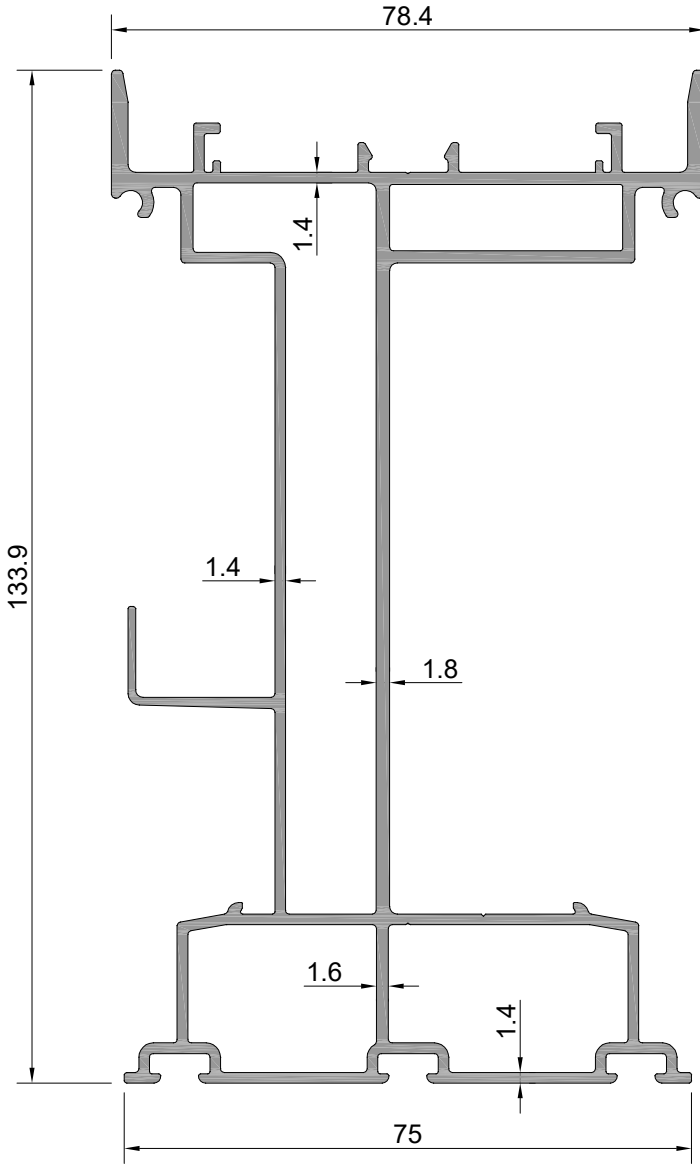

Profil No: OB1-107
Ağırlık : 2636 gr/m

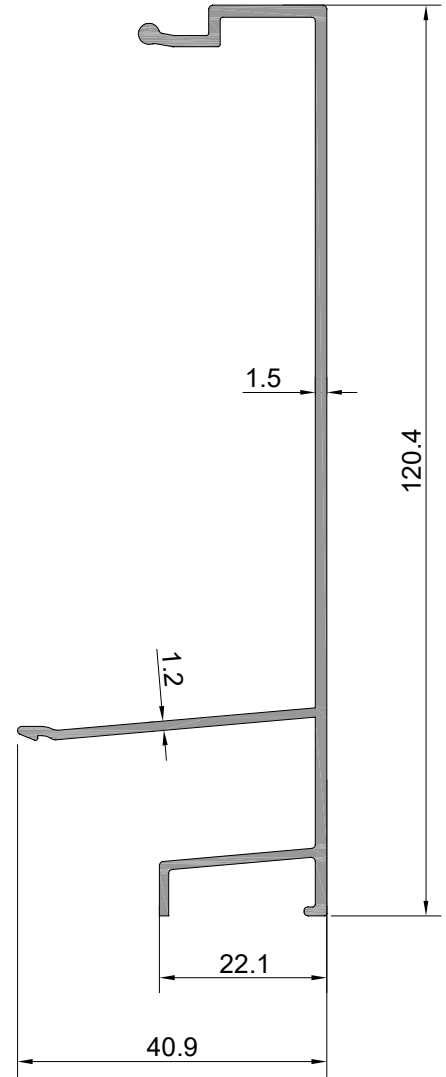

Profil No: OB1-108
Ağırlık : 836 gr/m

OB1 - 120
STRÜKTÜREL BÖLME
VISION PARTITION

ÜRÜN TEKNİK ÖZELLİKLERİ
PRODUCT'S TECHNICAL FEATURES

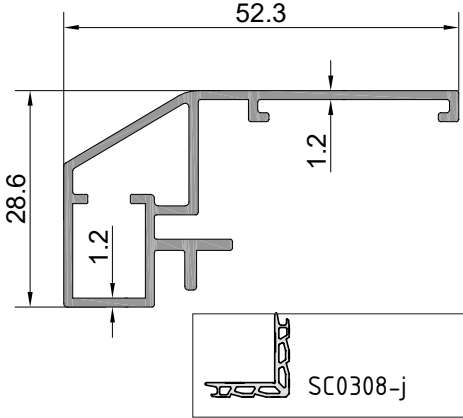

Profil No: OB1-110
Ağırlık : 487 gr/m

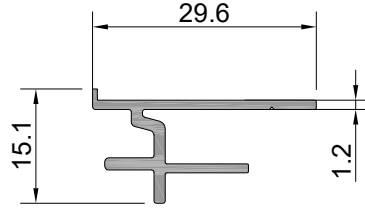

Profil No: OB1-111
Ağırlık : 222 gr/m

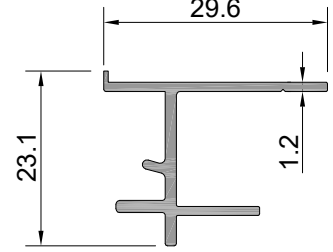

Profil No: OB1-112
Ağırlık : 255 gr/m

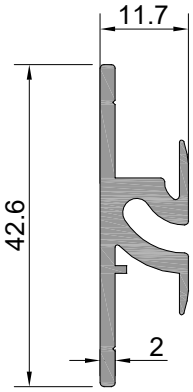

Profil No: OB1-201
Ağırlık : 454 gr/m

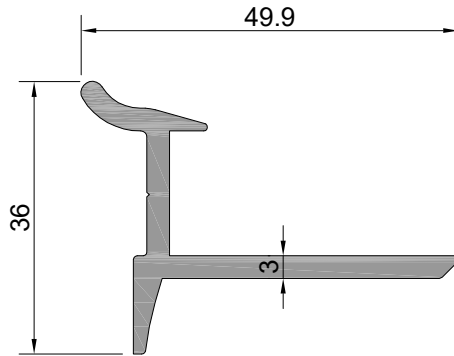

Profil No: OB1-202
Ağırlık : 666 gr/m

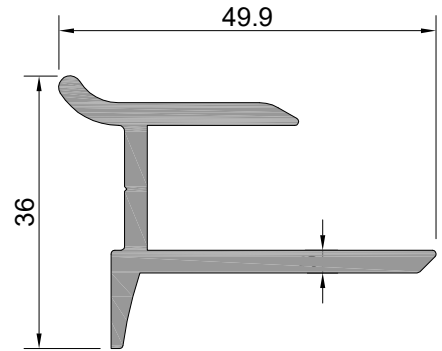

Profil No: OB1-203 ⚠
Ağırlık : 798 gr/m
⚠ İşaretili profil için satış temsilcinizden bilgi alınız.

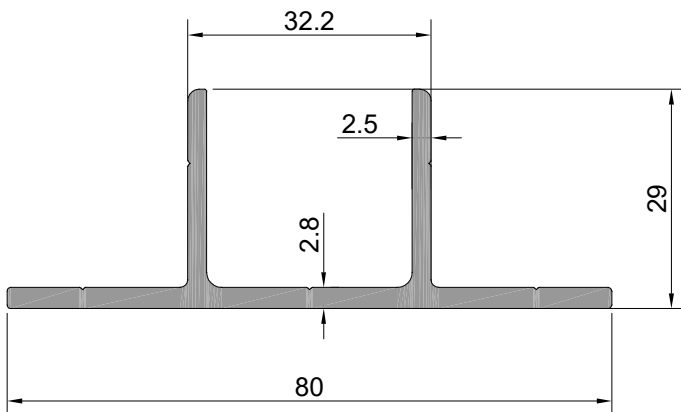

Profil No: OB1-204
Ağırlık : 963 gr/m

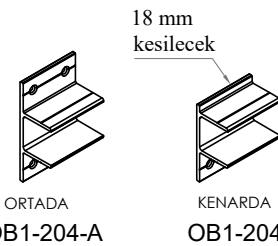

OB1 - 120
STRÜKTÜREL BÖLME
VISION PARTITION

ÜRÜN TEKNİK ÖZELLİKLERİ
PRODUCT'S TECHNICAL FEATURES

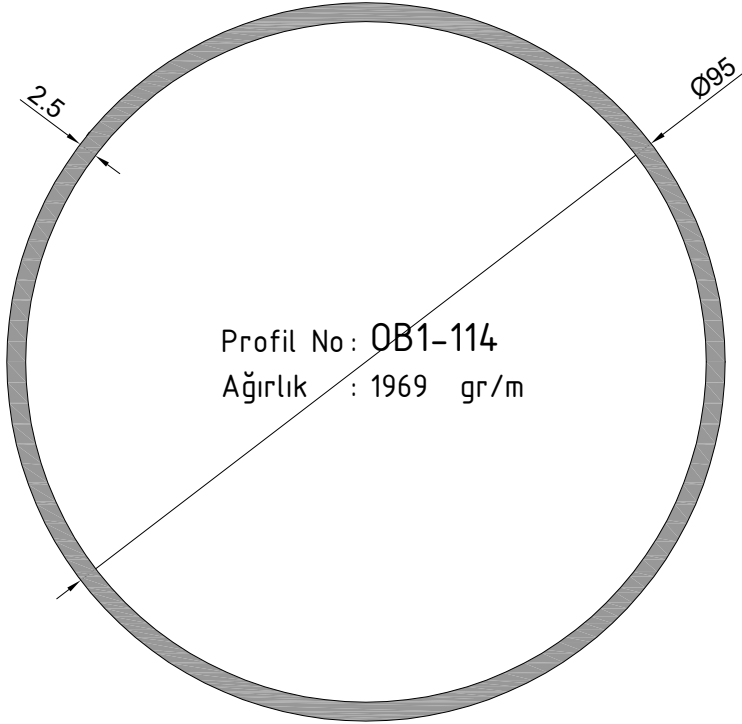

Profil No: OB1-113 ⚠
Ağırlık : 57 gr/m

⚠ İşaretili profil için satış temsilcinizden bilgi alınız.

SC0308-j	9.2 mm	100 adet/pcs
SC0308-k	39 mm	100 adet/pcs

Profil No: SC0308
Ağırlık : 2392 gr/m

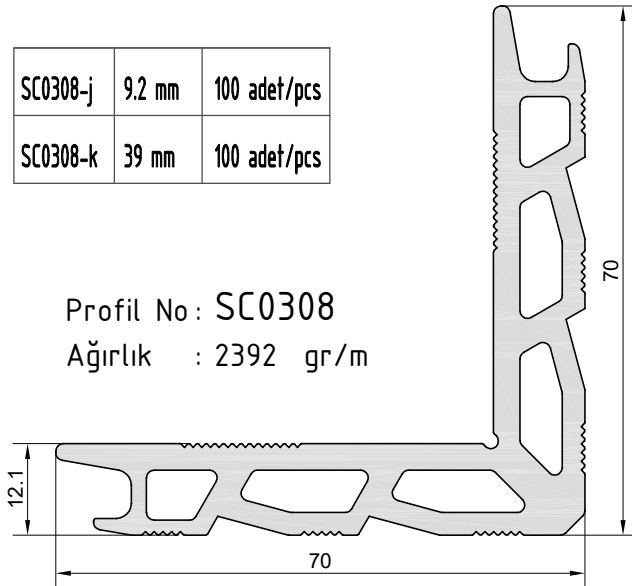

OB1 - 120
STRÜKTÜREL BÖLME
VISION PARTITION

ÜRÜN TEKNİK ÖZELLİKLERİ
PRODUCT'S TECHNICAL FEATURES

GÖNYE KÖŞE BAĞLANTI

D-872

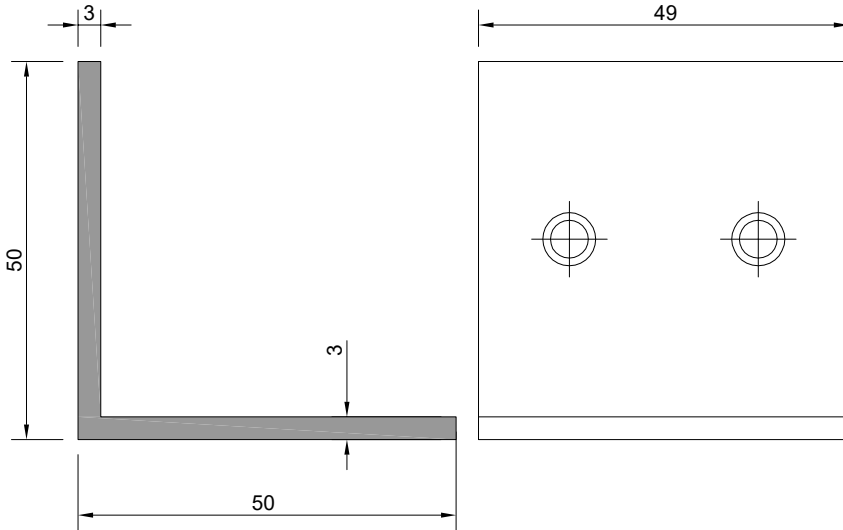
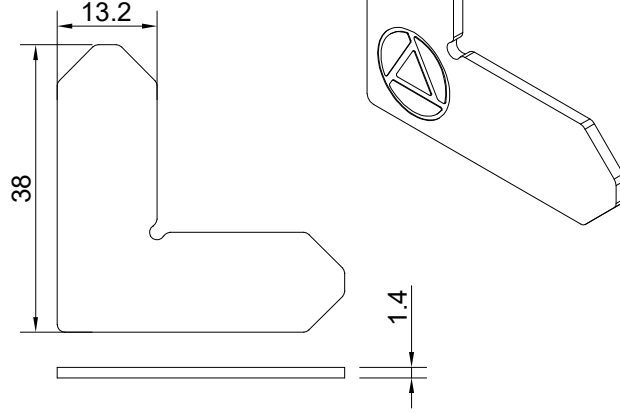

Profil No OB1-205
Ağırlık : 789 gr/m

L KÖŞE BAĞLANTI

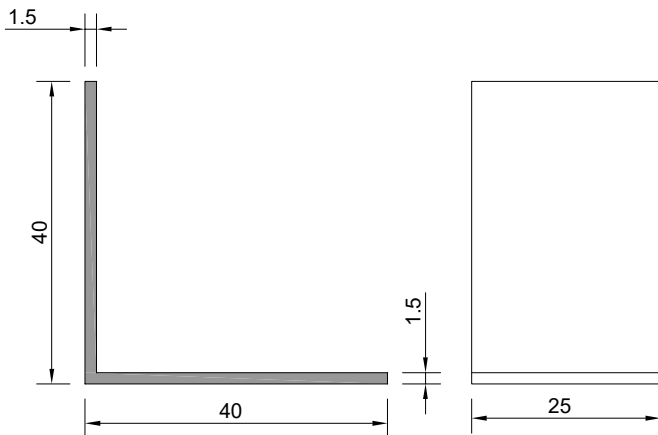
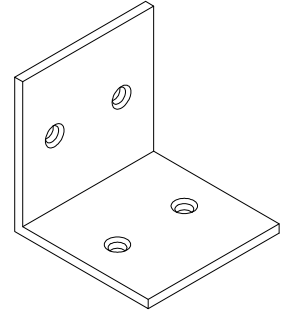

Profil No OB1-206
Ağırlık : 319 gr/m

L KÖŞE BAĞLANTI

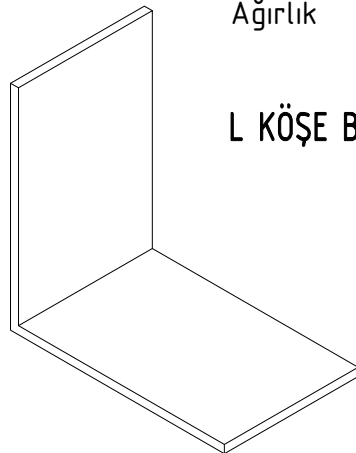

OB1 - 120
STRÜKTÜREL BÖLME
VISION PARTITION

DUVAR BİTİM - CAM

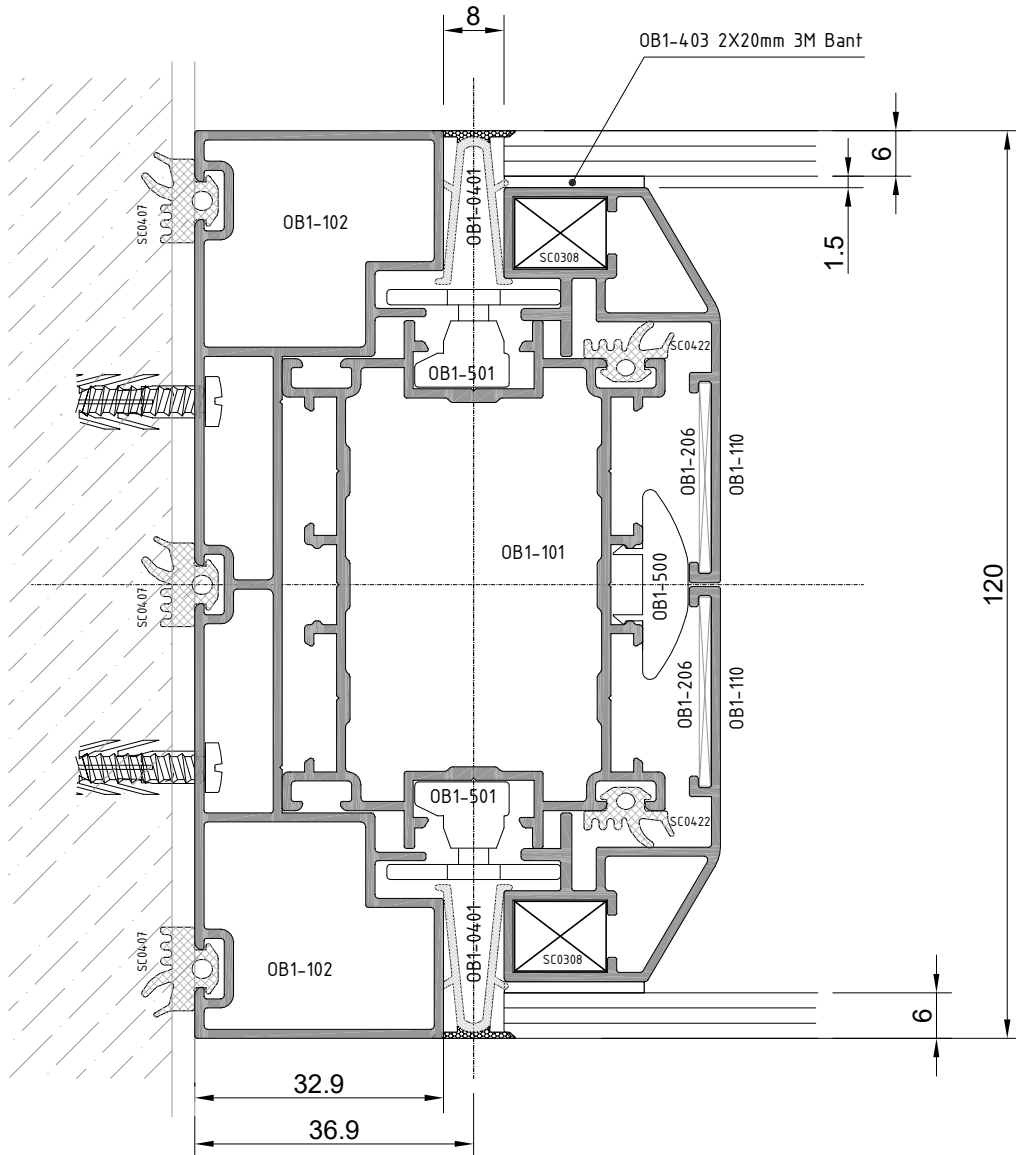
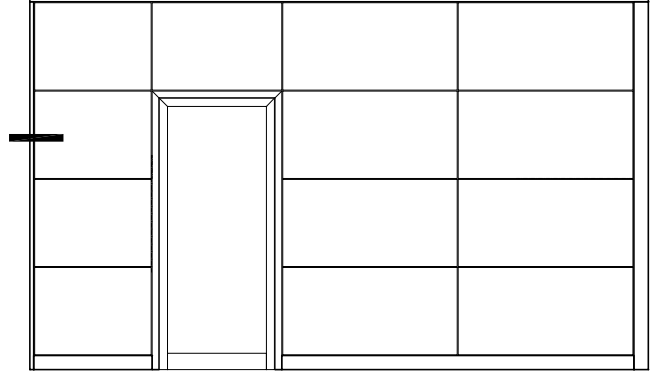

OB1 - 120
STRÜKTÜREL BÖLME
VISION PARTITION

CAM-CAM

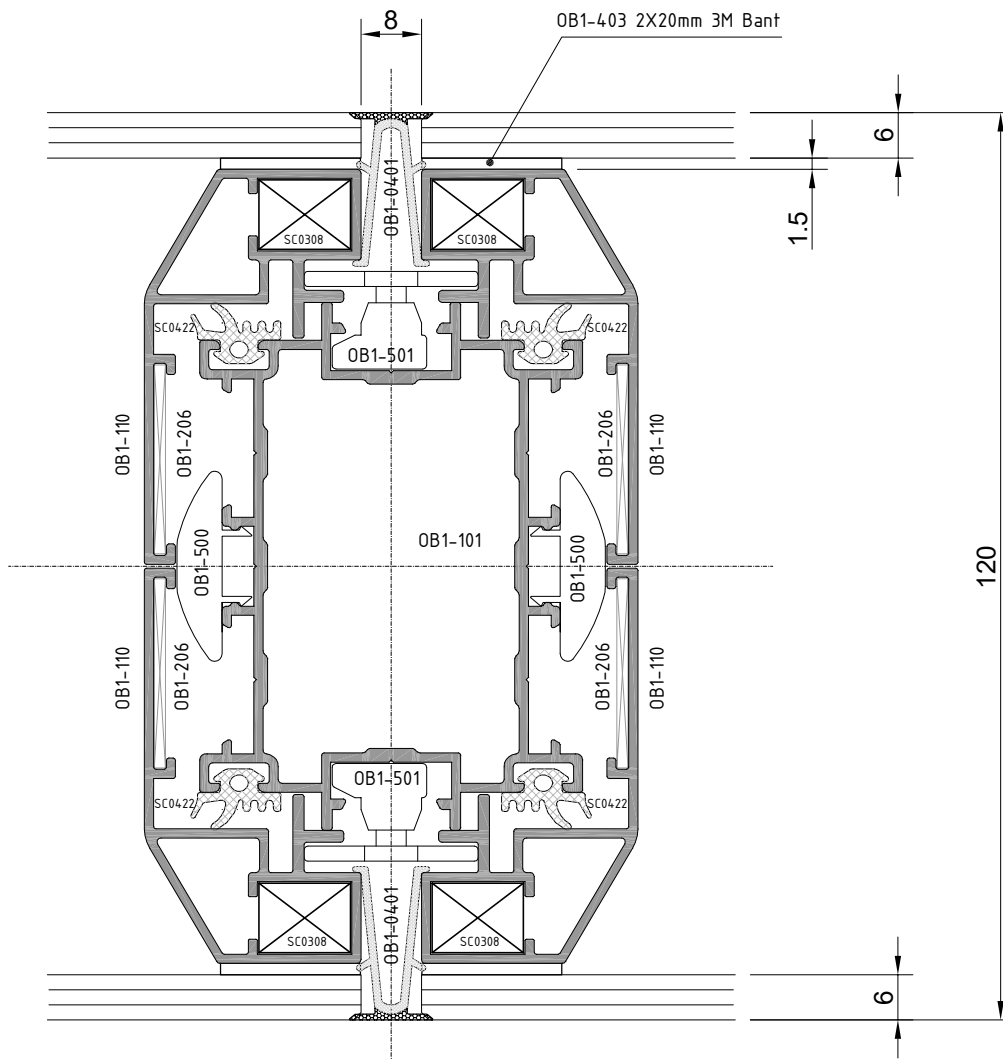
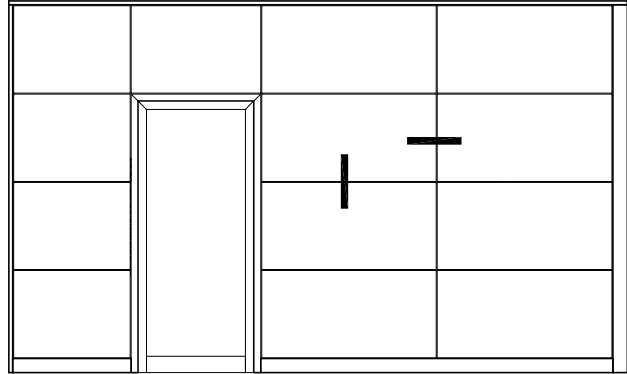

OB1 - 120
STRÜKTÜREL BÖLME
VISION PARTITION

CAM - SUNTALAM & MDF

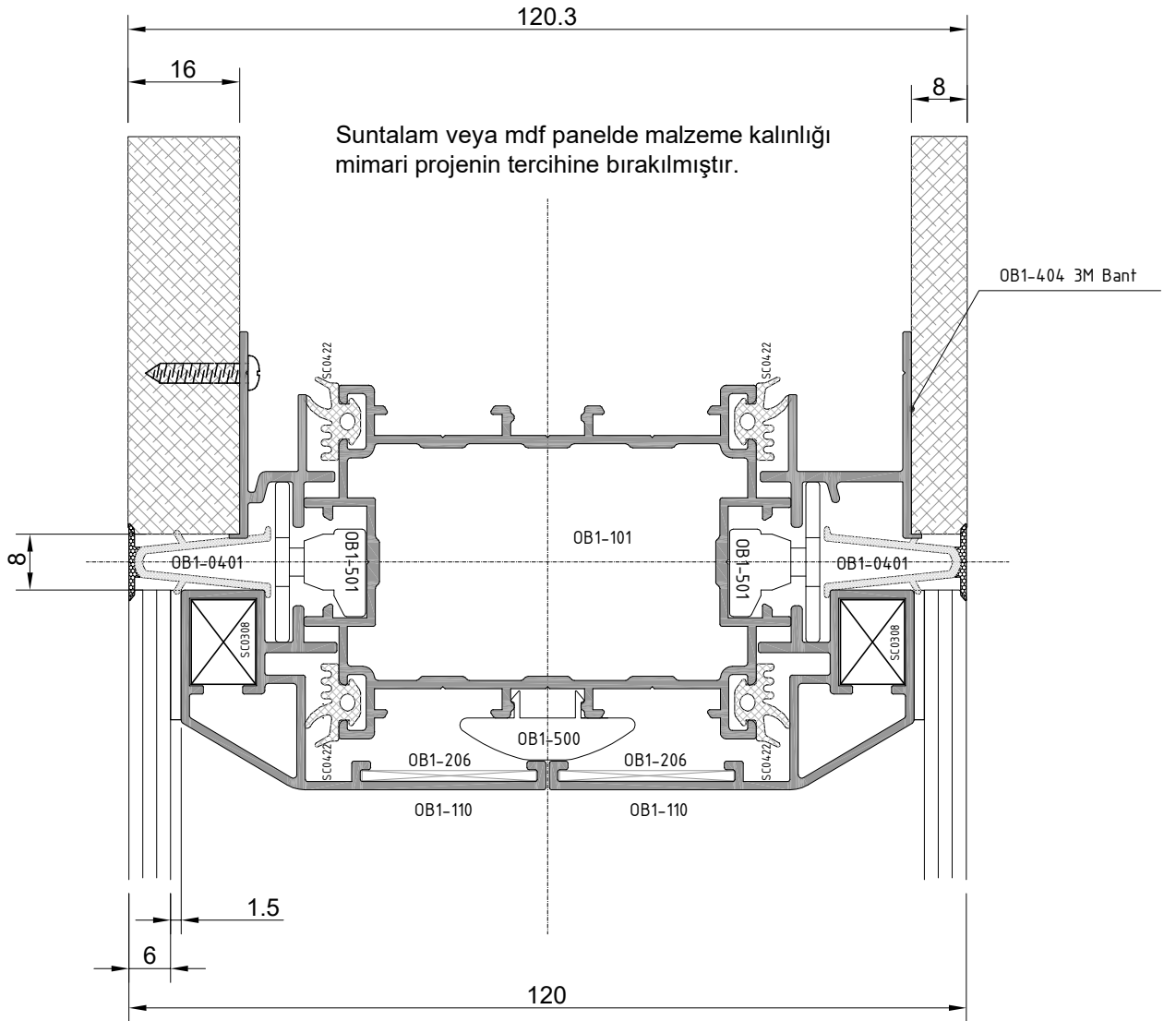
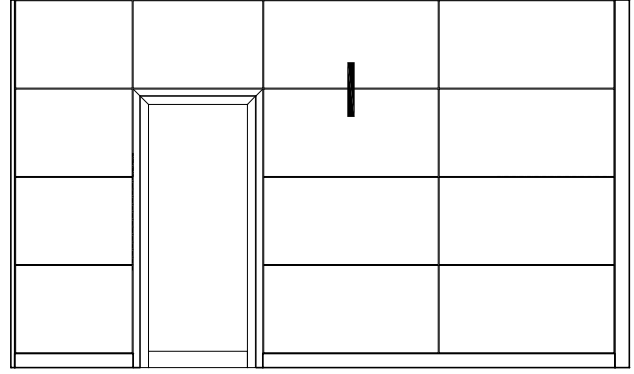

OB1 - 120
STRÜKTÜREL BÖLME
VISION PARTITION

TAVAN BİTİM - SUNTALAM & MDF

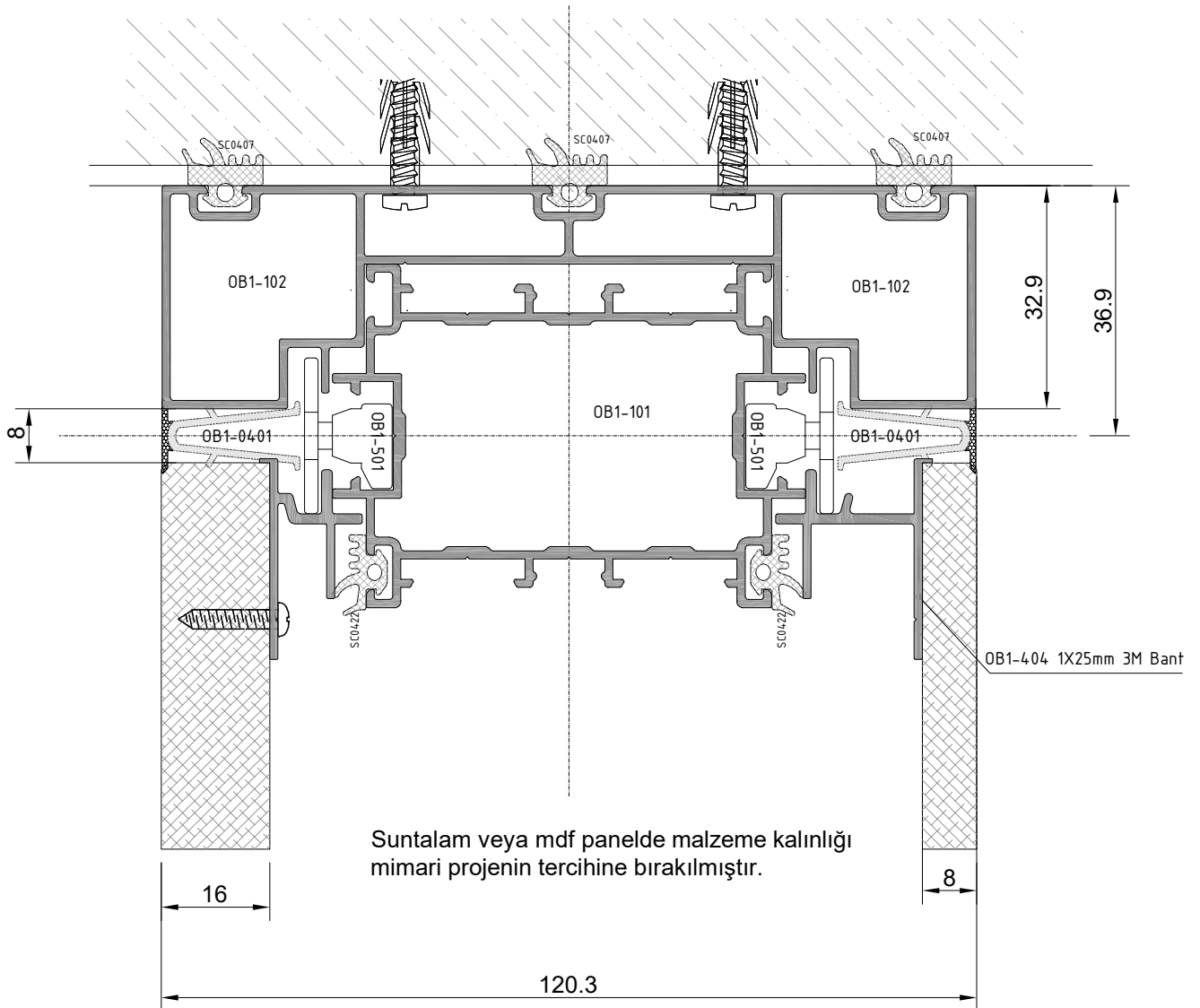
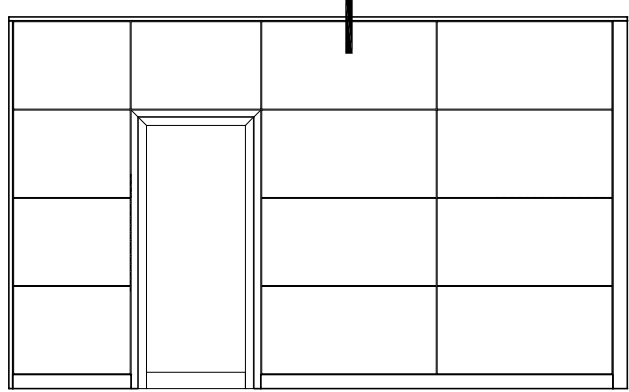

OB1 - 120
STRÜKTÜREL BÖLME
VISION PARTITION

CAM - 90° KÖŞE DÖNÜŞ

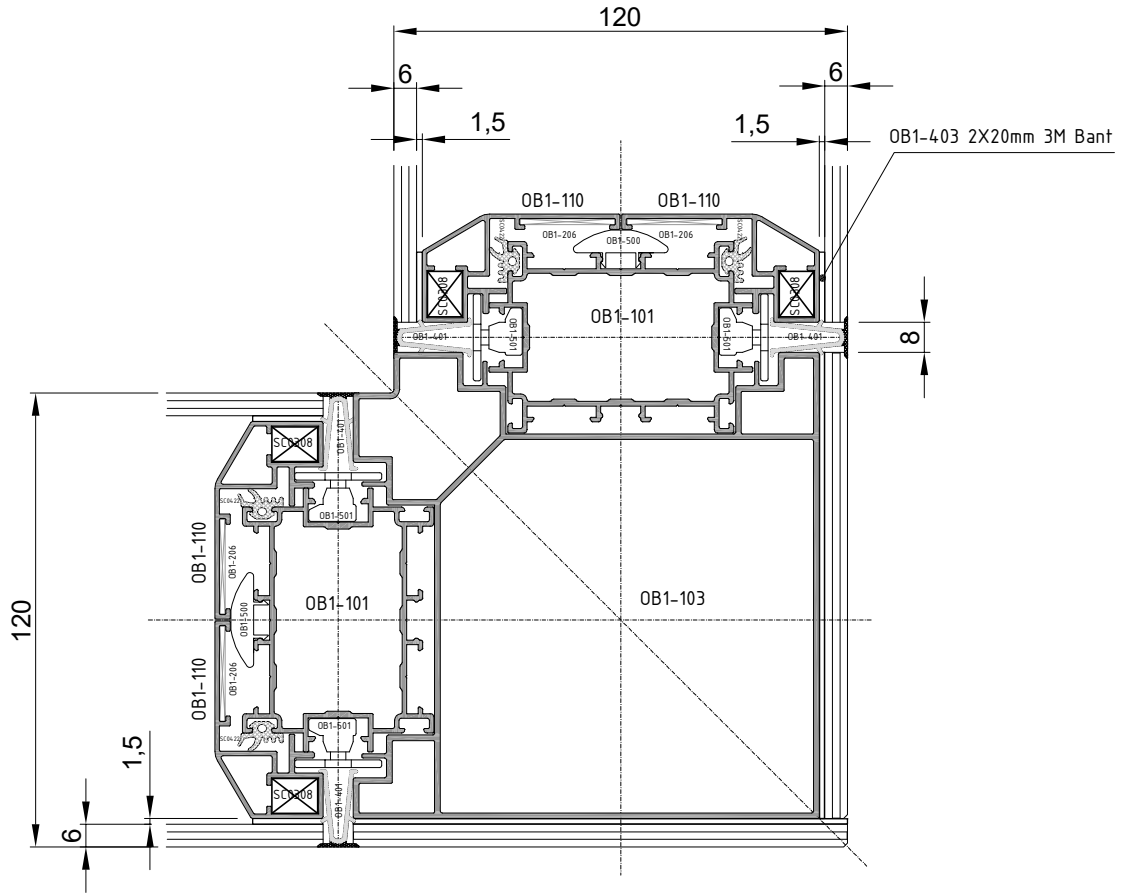
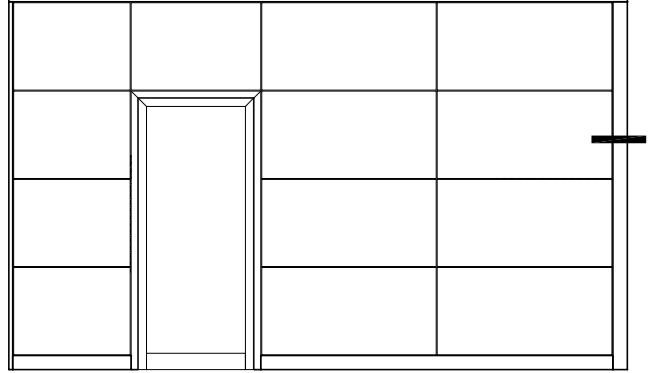

ÖLÇEK : 1/2

OB1 - 120
STRÜKTÜREL BÖLME
VISION PARTITION

CAM - 90° KÖŞE DÖNÜŞ

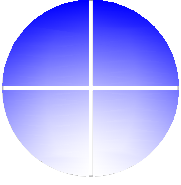

alutech
part

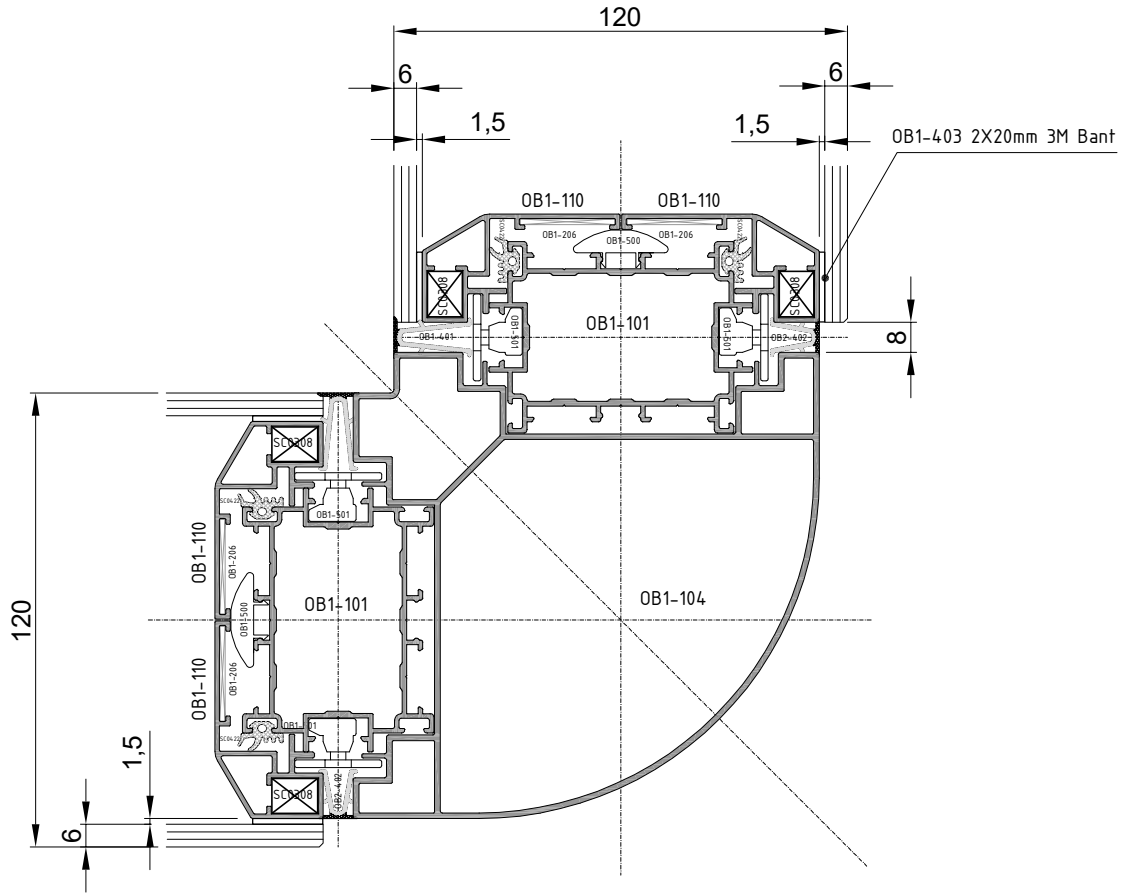
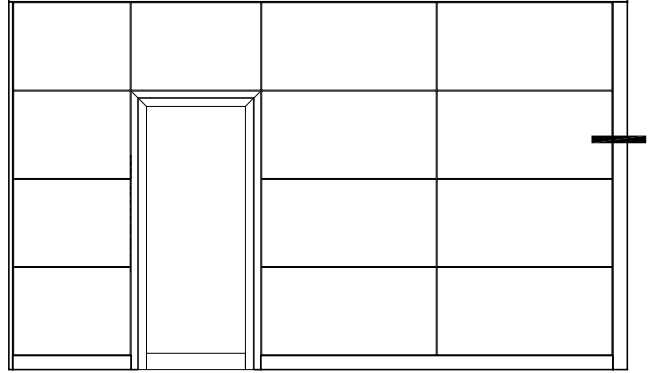

ÖLÇEK : 1/2

OB1 - 120
STRÜKTÜREL BÖLME
VISION PARTITION

CAM & MDF - SÜPÜRGELİK

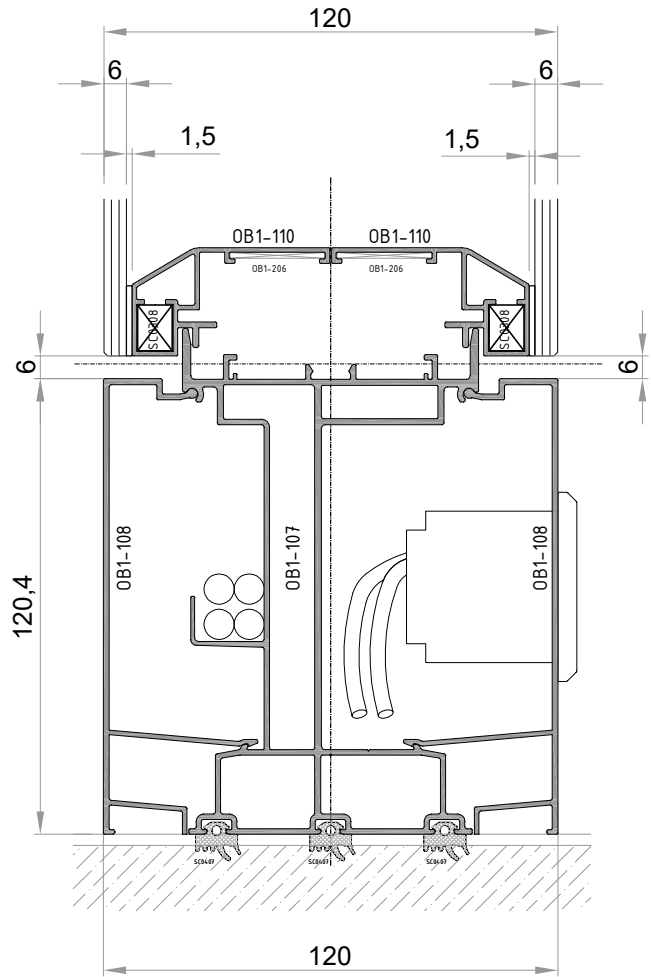
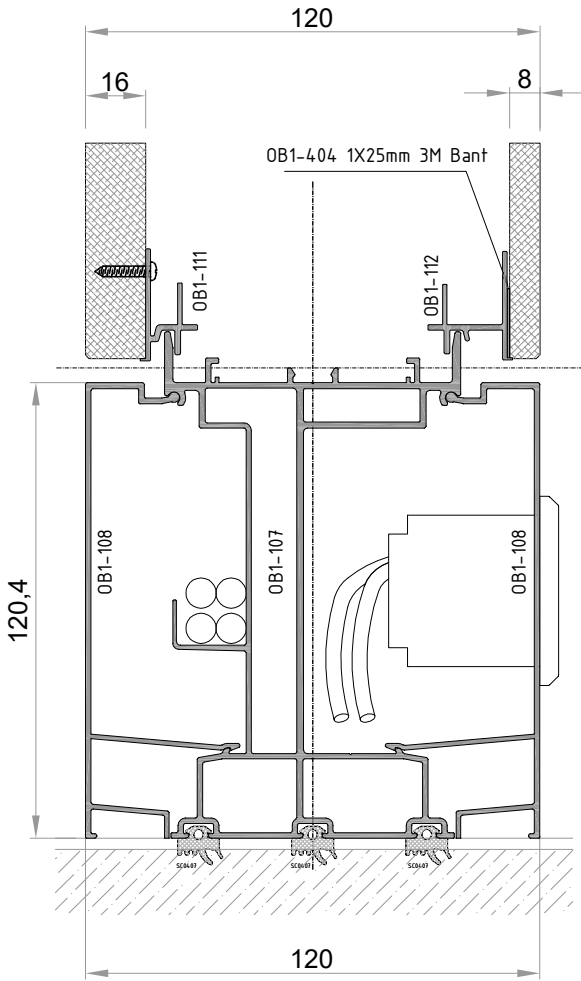
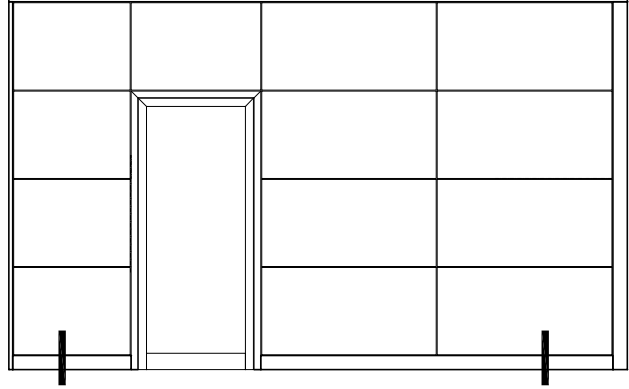

OB1 - 120
STRÜKTÜREL BÖLME
VISION PARTITION

CAM - W2 SERİ KAPI

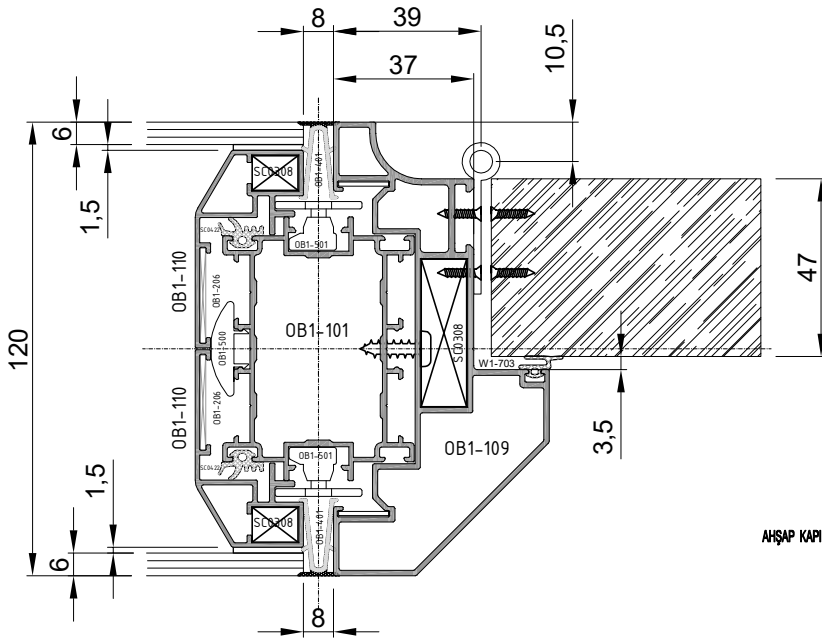
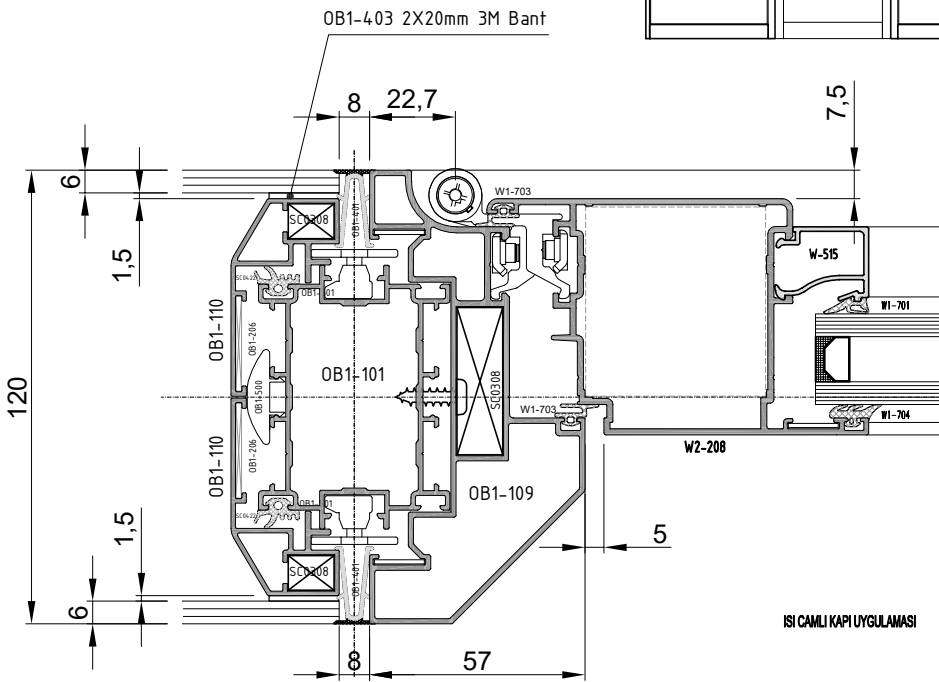
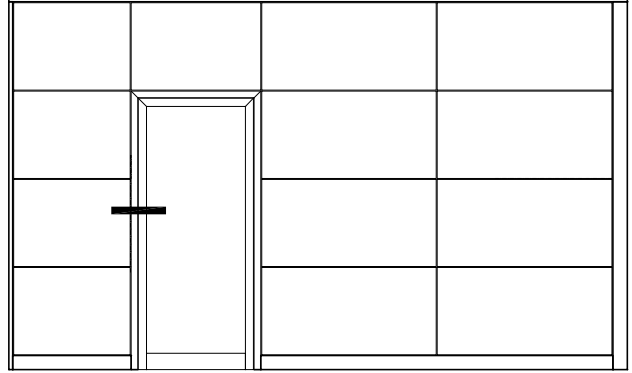

TALEP OLURSA ÜRETİLECEK

ÖLÇEK : 1/2

OB1 - 120
STRÜKTÜREL BÖLME
VISION PARTITION

W2 SERİ KAPI

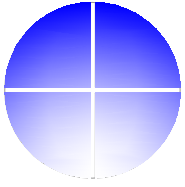

alutech
part

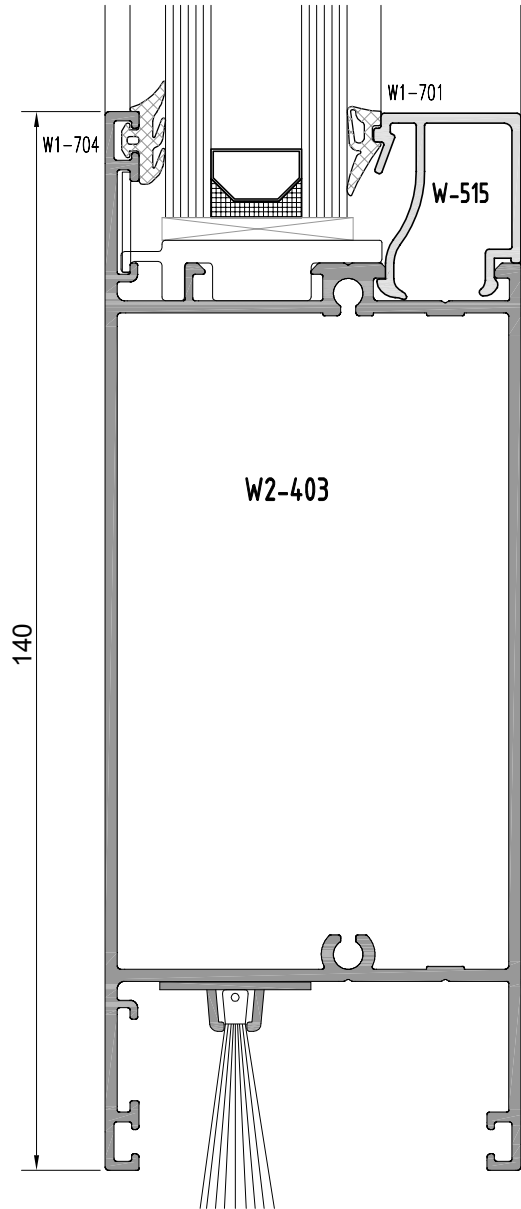
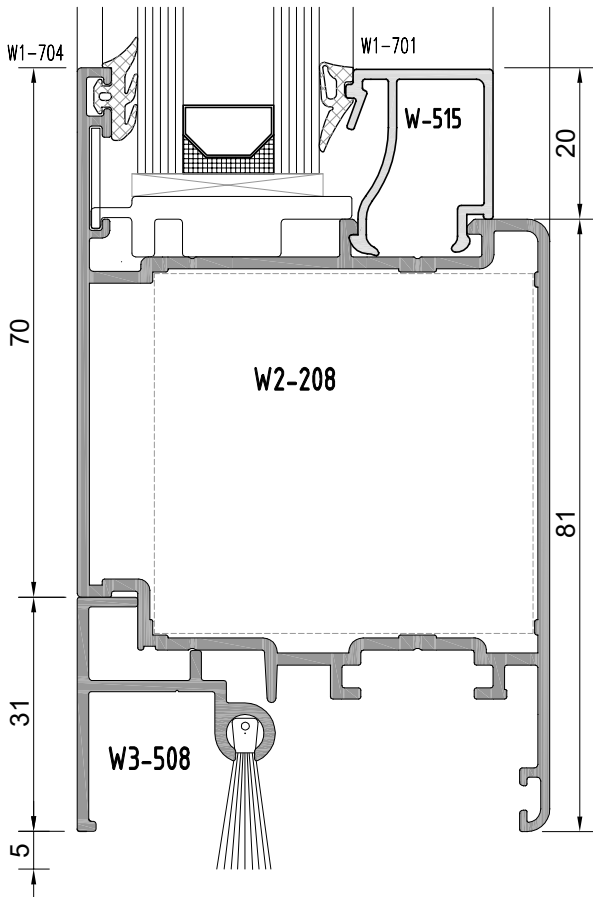
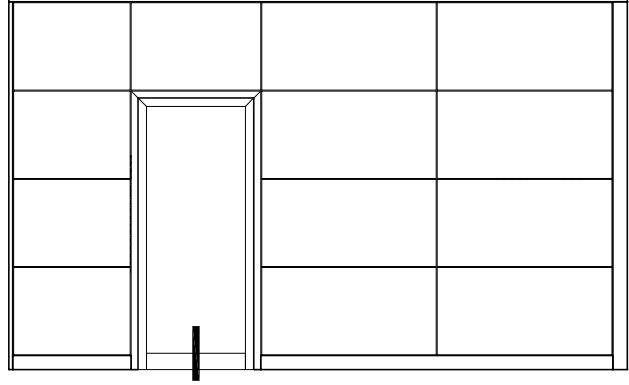

OB1 - 120
STRÜKTÜREL BÖLME
VISION PARTITION

MUHTELİF AÇILARDA KÖŞE DÖNÜŞ

.....

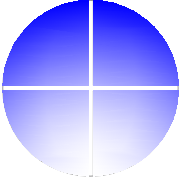

alutech
part

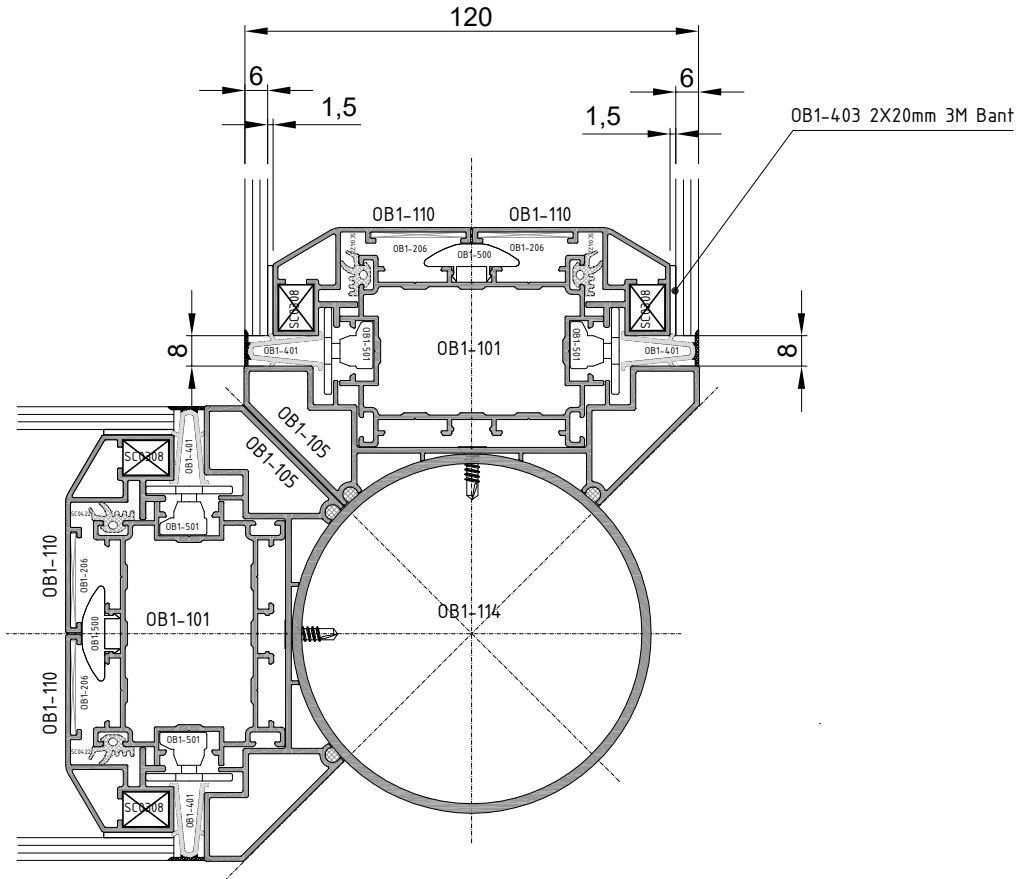
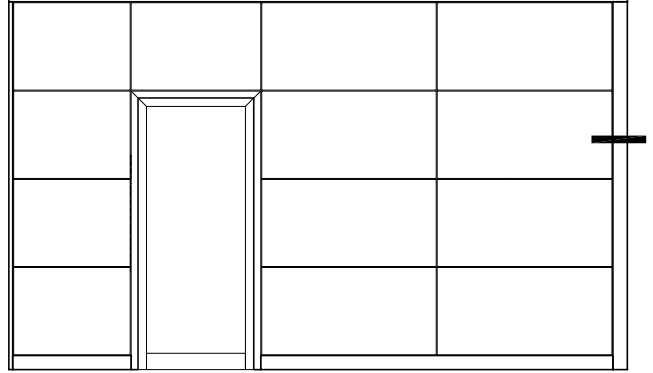

MUHTELİF AÇILARDA KÖŞE DÖNÜŞ

OB1 - 120
STRÜKTÜREL BÖLME
VISION PARTITION

RAF VE DOLAP ASKI

.....

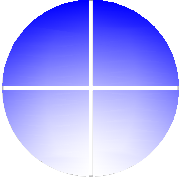

alutech
part

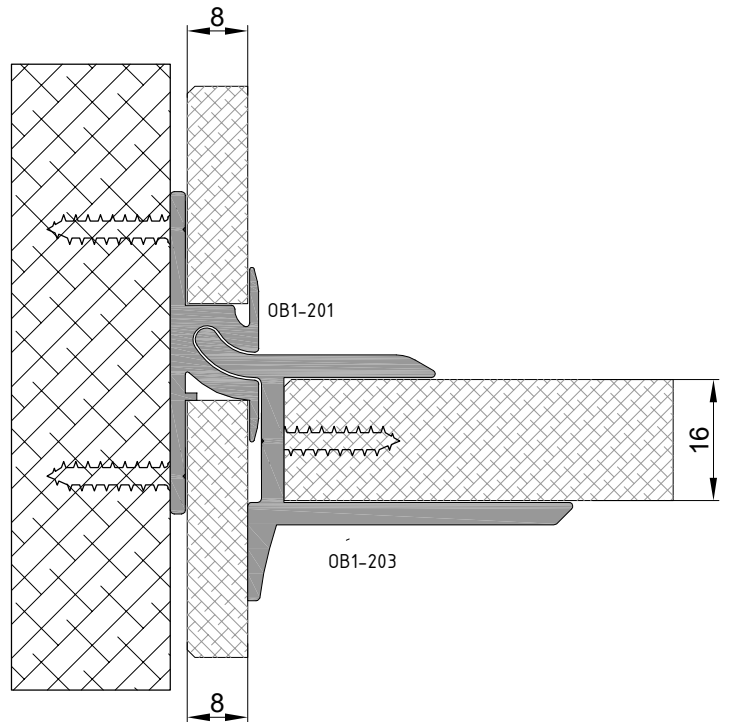
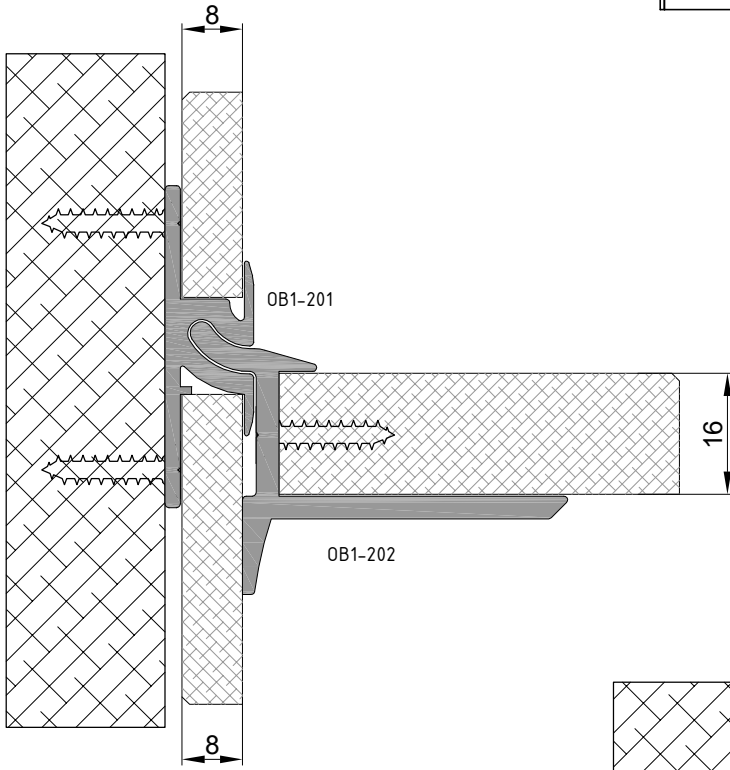
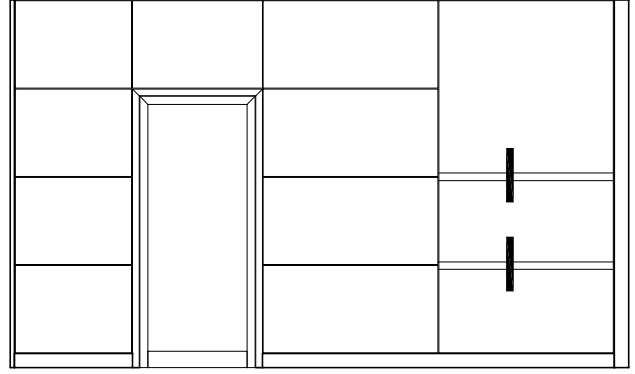

OB1 - 120
STRÜKTÜREL BÖLME
VISION PARTITION

RAF VE DOLAP ASKI

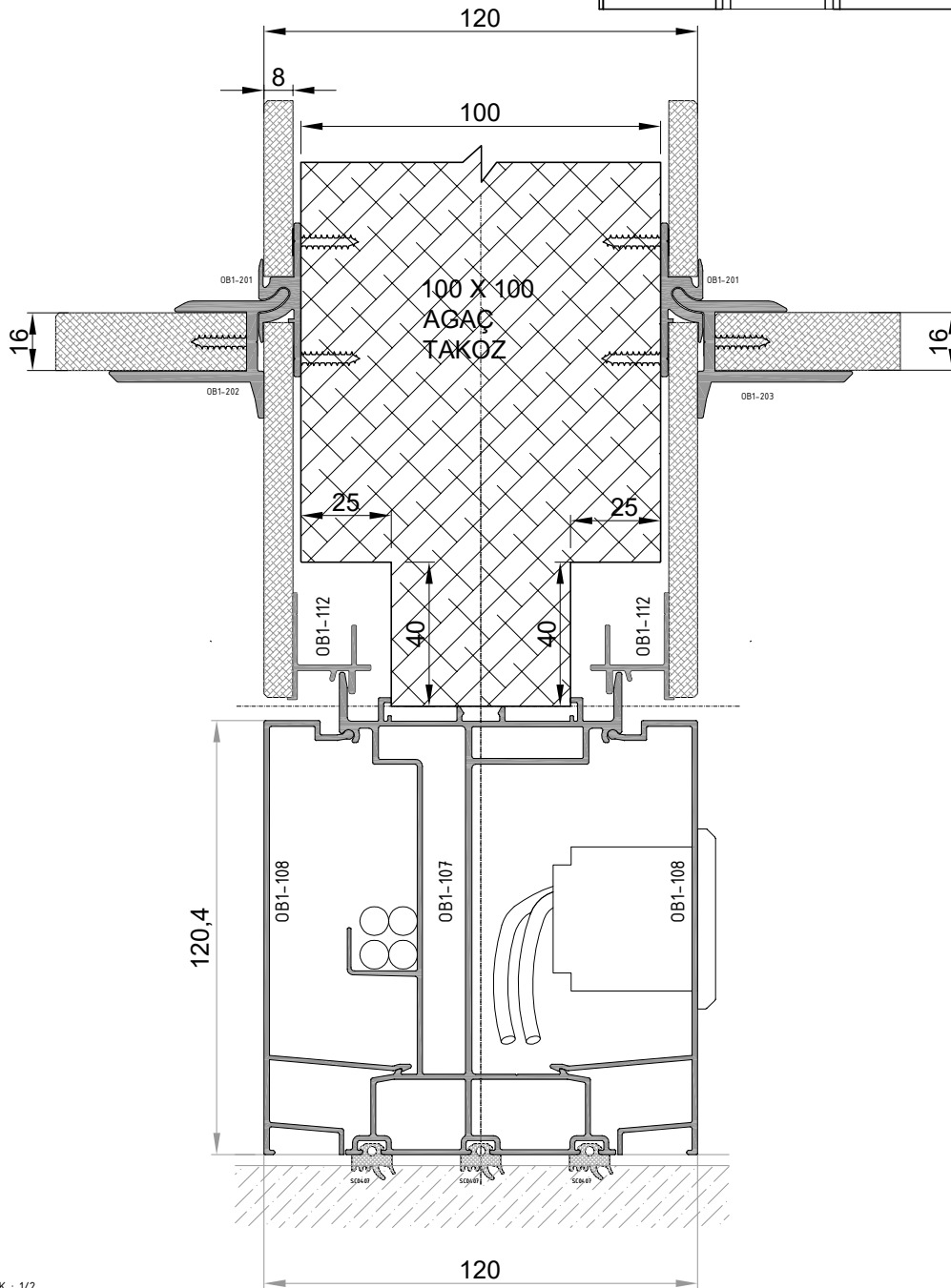
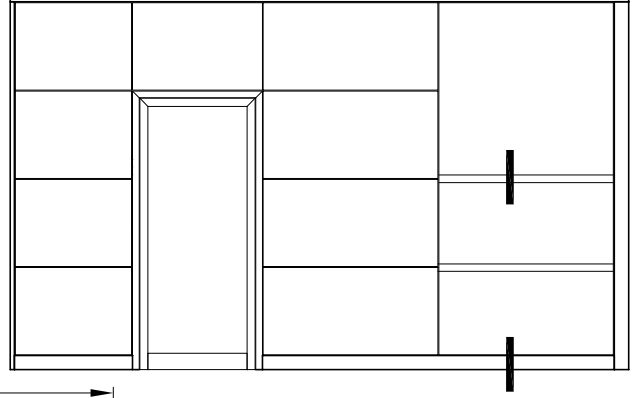

OB1 - 120
STRÜKTÜREL BÖLME
VISION PARTITION

İMALAT ŞEMASI
PRODUCTION PLAN

vision partition

frame partition

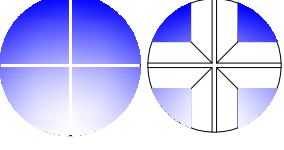

TAVAN, DUVAR BİTİM
PROFİL İMALAT ÖLÇÜSÜ

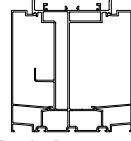

SÜPÜRGE LİK GÖVDE VE KAPAK
İMALAT ÖLÇÜLERİ



YATAY VE DÜŞEY TAŞIYICI
PROFİL İMALAT ÖLÇÜLERİ

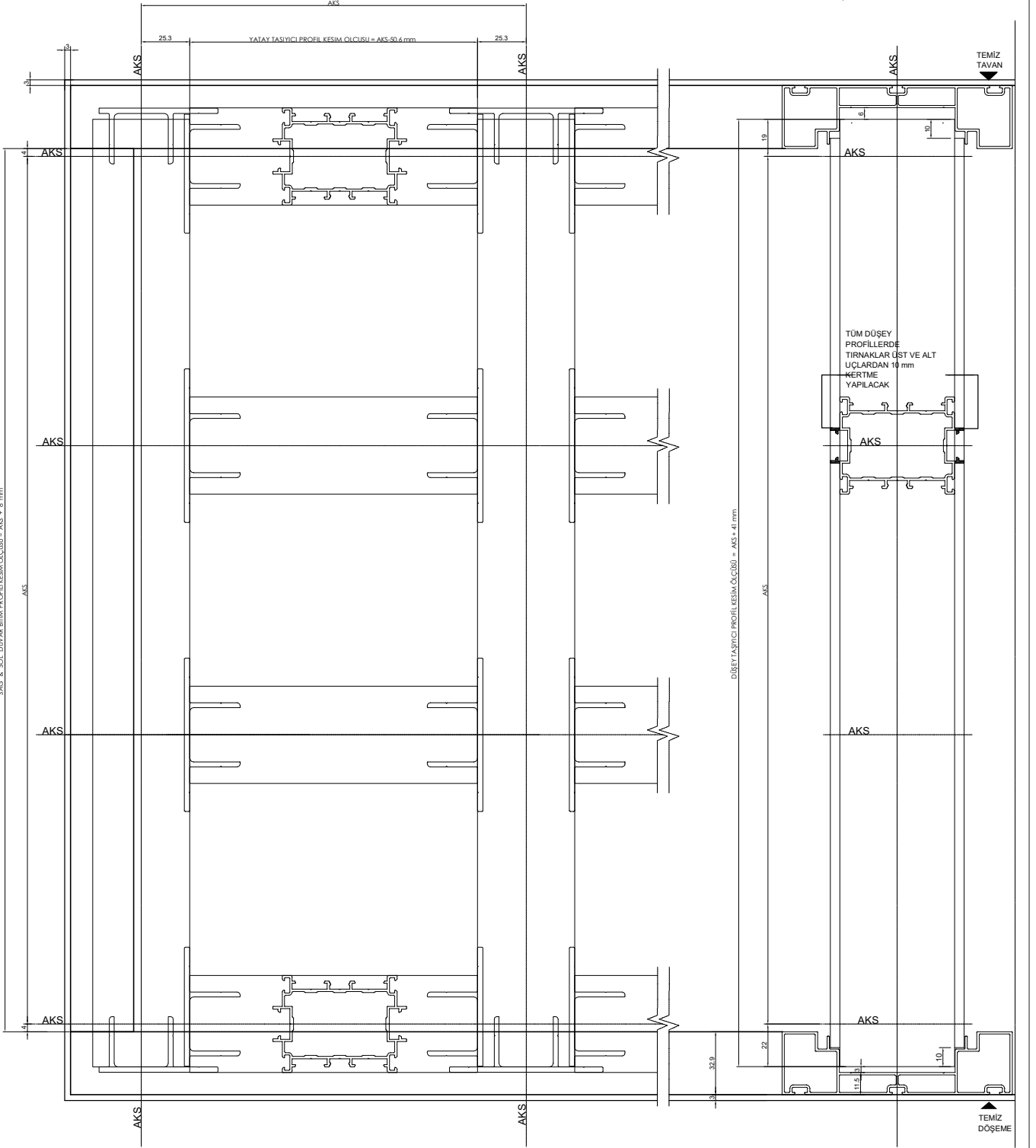
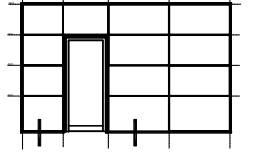

TAVAN ,ZEMİN, SAĞ VE SOL DUVAR BİTİMİNE OB1-102 PROFİL KULLANILDIĞINDA; YATAY, DÜŞEY PROFİLLERİN İMALAT VE MONTAJ ÖLÇÜLERİ

OB1 - 120

STRÜKTÜREL BÖLME

VISION PARTITION

İMALAT ŞEMASI
PRODUCTION PLAN

vision partition

frame partition

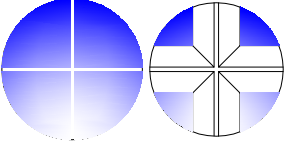

TAVAN, DUVAR BİTİM
PROFİL İMALAT ÖLÇÜSÜ

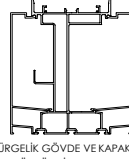

SÜPÜRĞELİK GÖVDE VE KAPAK
İMALAT ÖLÇÜLERİ

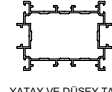

YATAY VE DÜŞEY TAŞIYICI
PROFİL İMALAT ÖLÇÜLERİ

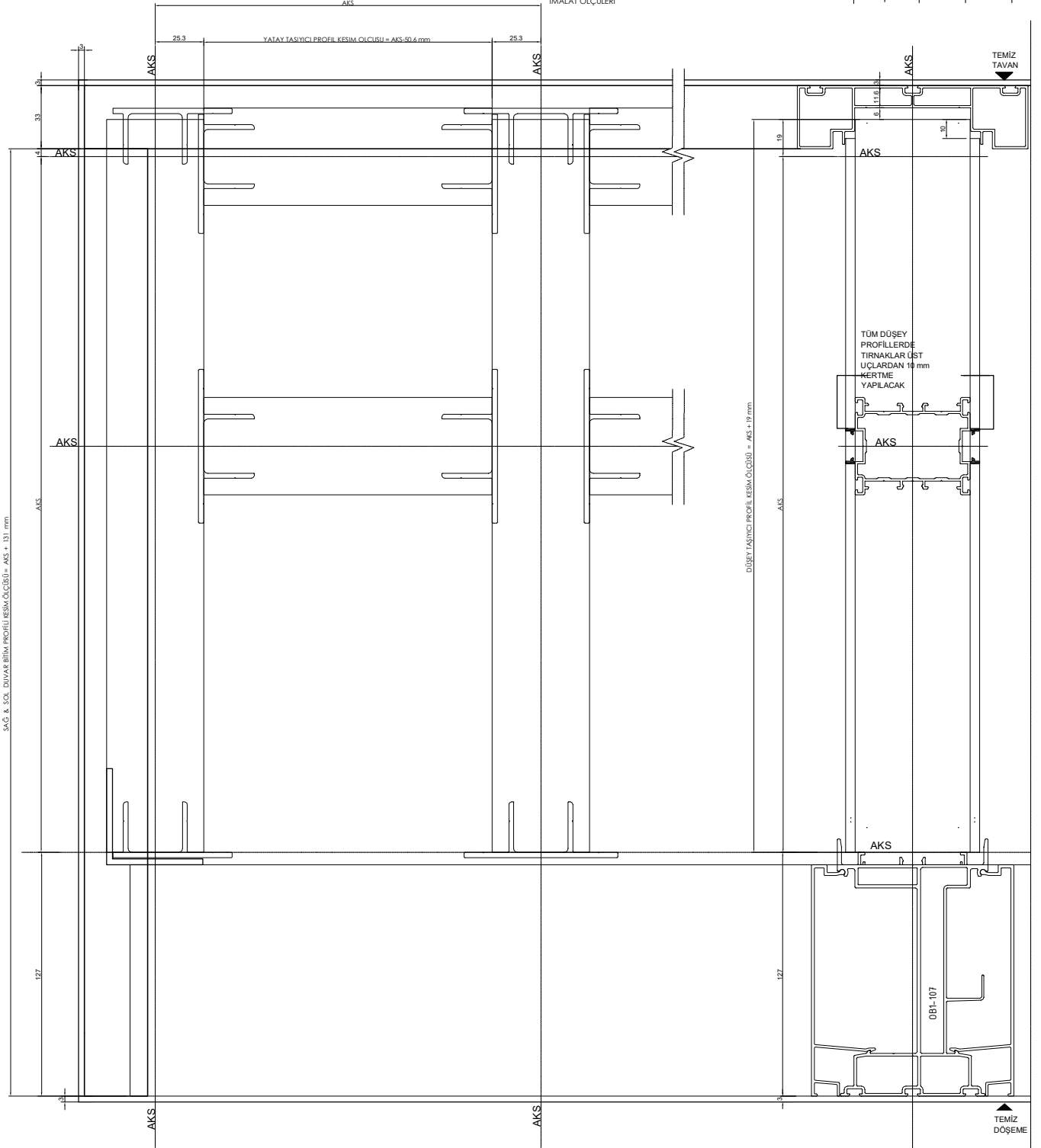
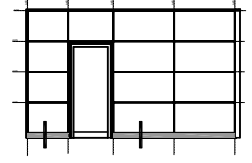

TAVAN , SAĞ VE SOL DUVAR BİTİMİNE OB1-102 PROFİL,
ZEMİNE OB1-107 KABLO KANALLI SÜPÜRĞELİK PROFİL KULLANILDIĞINDA
YATAY, DÜŞEY PROFİLLERİN İMALAT VE MONTAJ ÖLÇÜLERİ

OB1 - 120

STRÜKTÜREL BÖLME

VISION PARTITION

İMALAT ŞEMASI
PRODUCTION PLAN

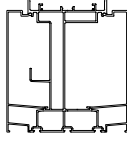
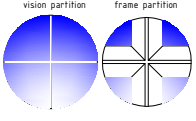

SÜPÜRGELİK GÖVDE VE KAPAK
İMALAT ÖLÇÜLERİ

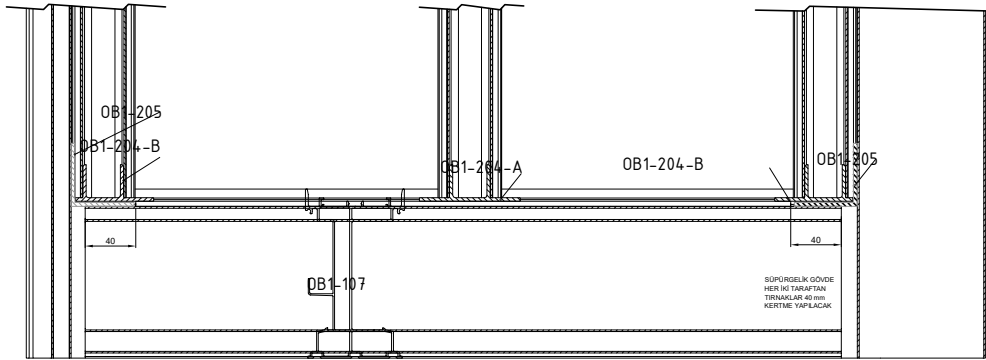
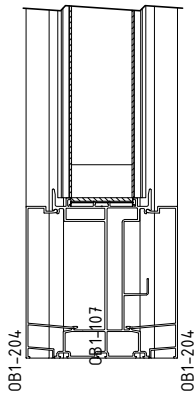
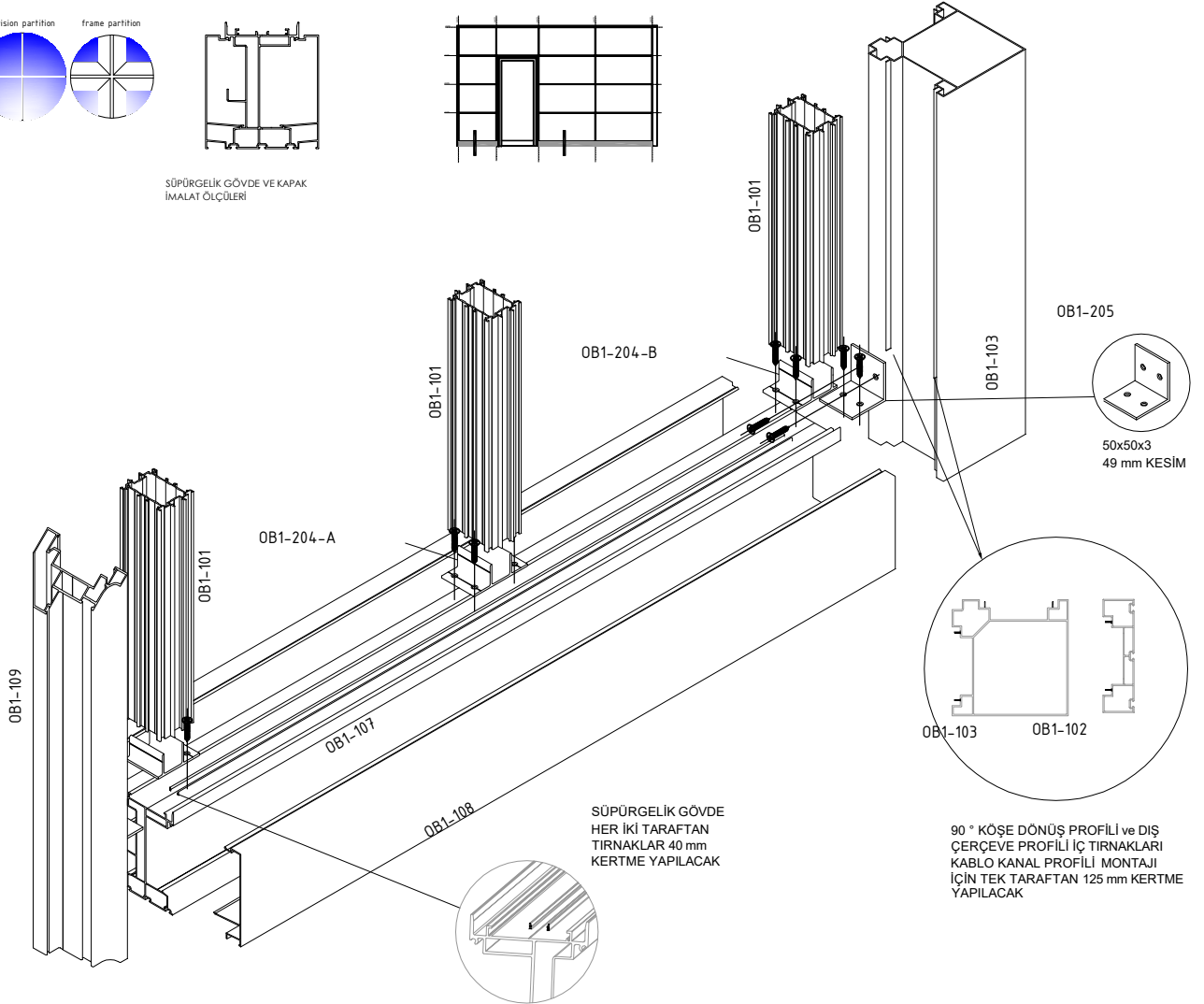
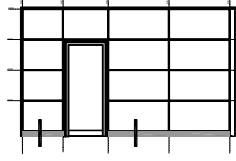

AKS 120

SÜPÜRGELİK KAPAK KESİM ÖLÇÜSÜ = AKS ÖLÇÜSÜ + 8 mm

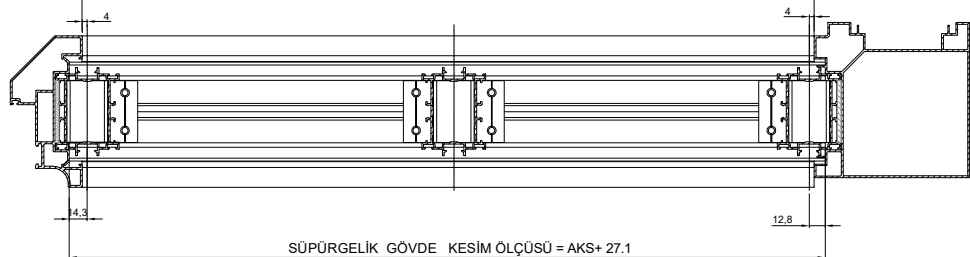

OB1 - 120
STRÜKTÜREL BÖLME
VISION PARTITION

İMALAT ŞEMASI
PRODUCTION PLAN

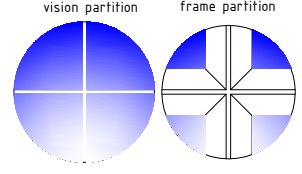
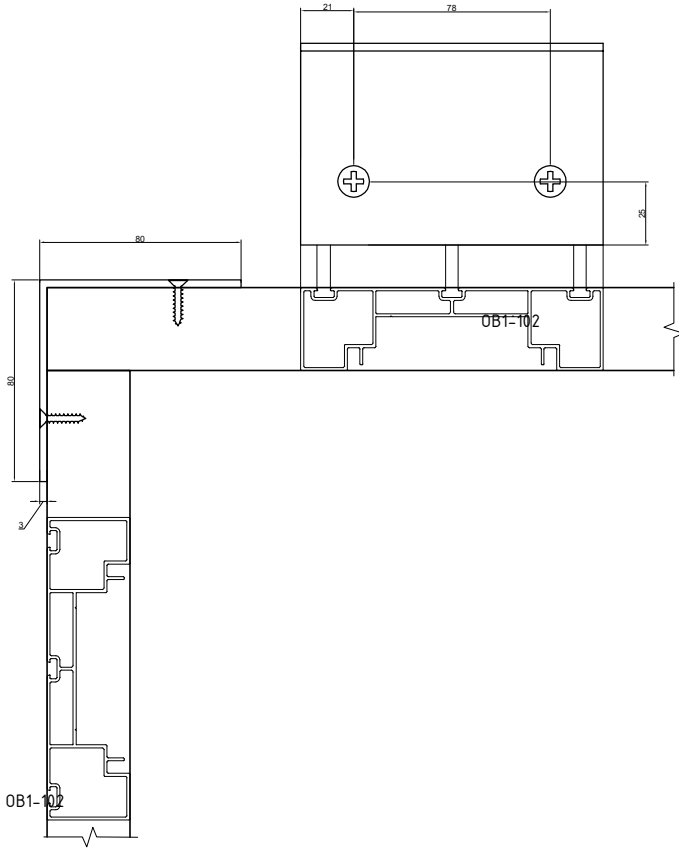

(A) düşey taşıyıcılar; c bağlantı profili alt taraftan sıfırlanacak üst taraftan 3 mm boşluk bırakılarak monte edilecek. Montaj yaparken alt taban sabitlendikten sonra üst bağlantı profili 3 mm yukarı kaldırıldıktan sonra sabitlecek

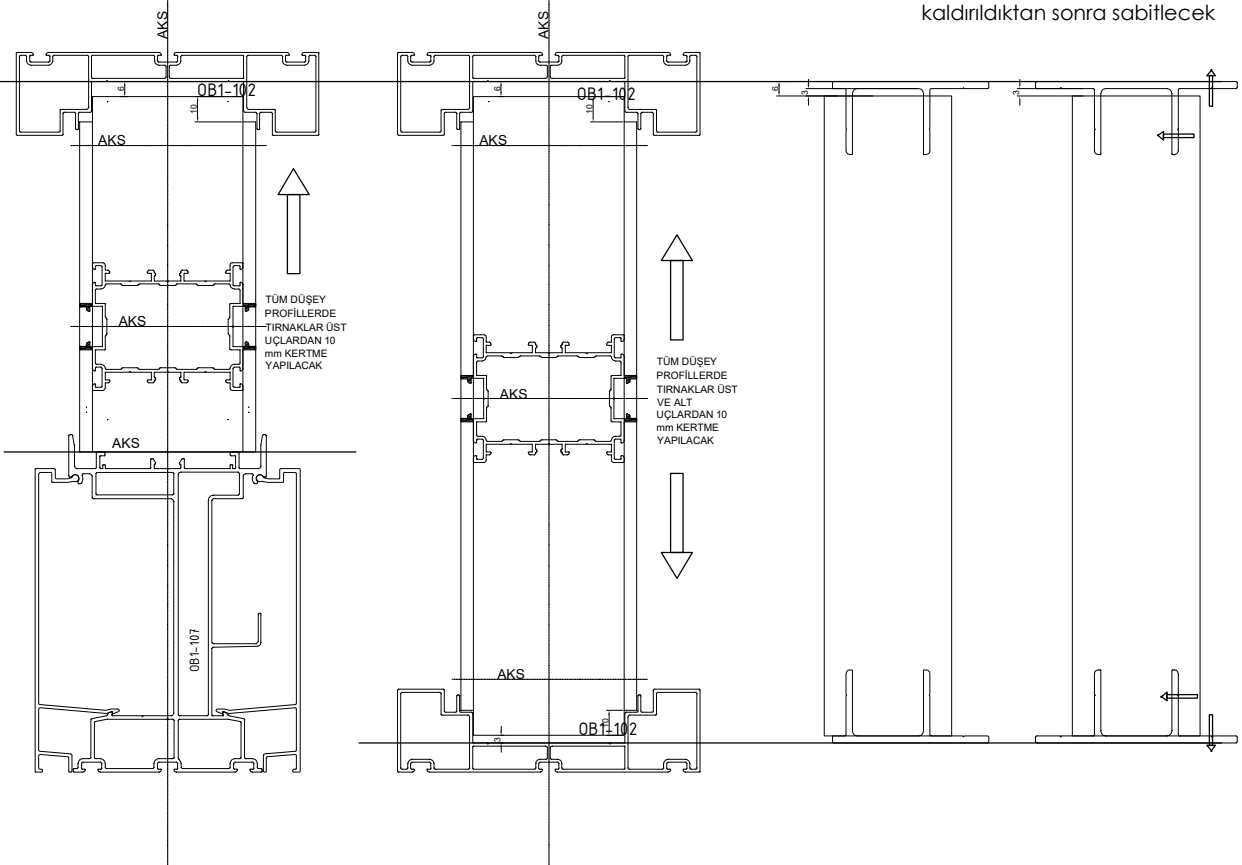

OB1 - 120

STRÜKTÜREL BÖLME

VISION PARTITION

İMALAT ÖLÇÜLERİ

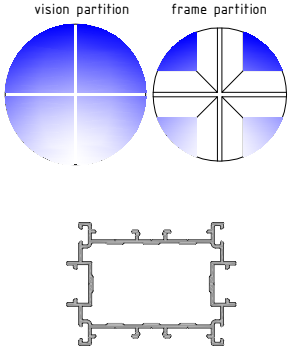

YATAY VE DÜŞEY
TAŞIYICI PROFİL
İMALAT ÖLÇÜLERİ

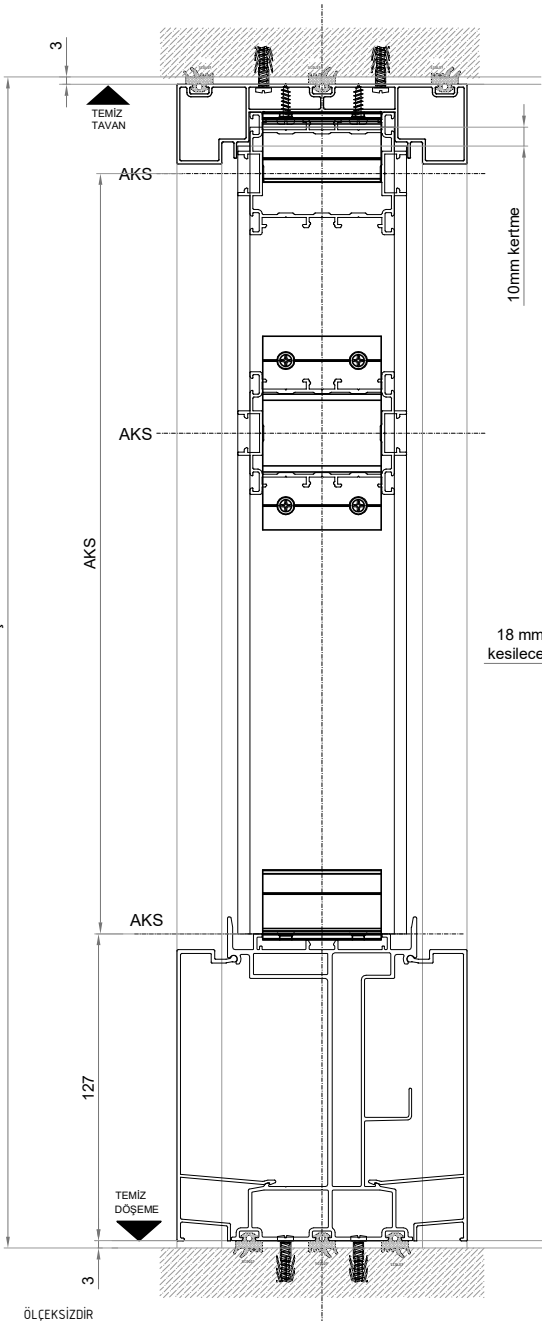
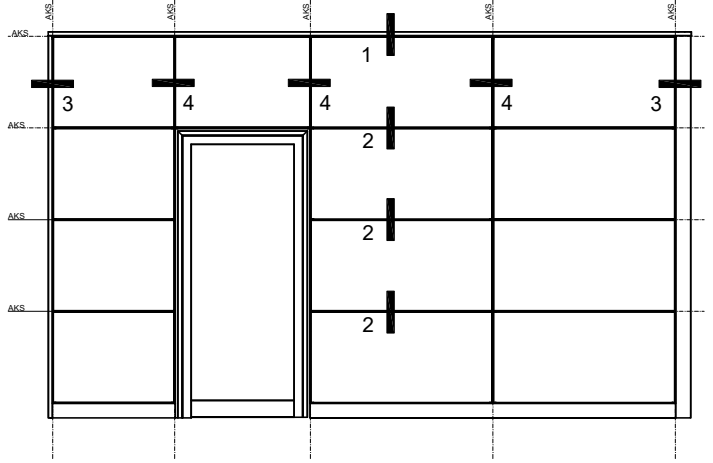

ÖLÇEKSİZDİR

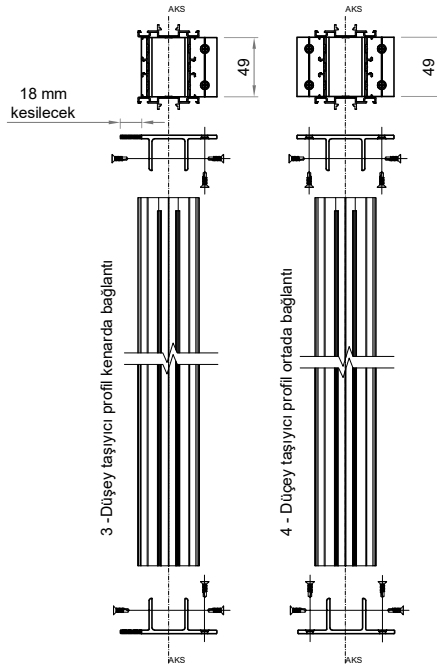
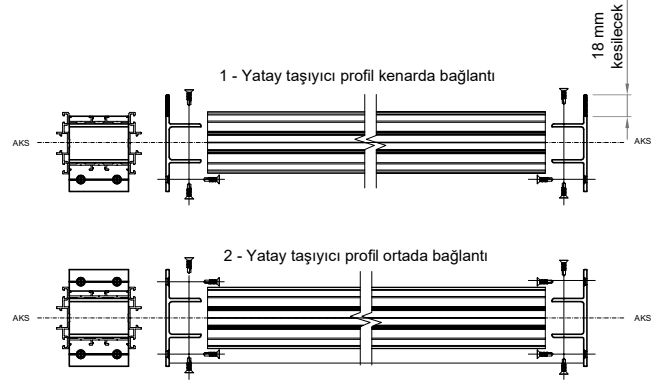

Kenardaki düşey ve yatay taşıyıcı profillerin birleşmelerinde kullanılacak "C" Bağlantı profili tek kulağı 18 mm kesilerek kullanılacak.

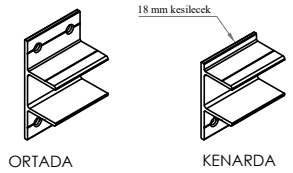

OB1-204-A

OB1-204-B

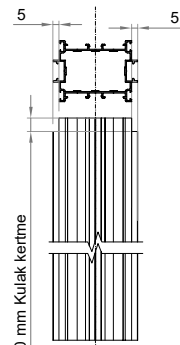

Zeminde OB1-107 kablo kanallı süpürgelik profili kullanıldığında bütün düşey taşıyıcı profiller tek taraftan kulakları 5 x 10 mm kертme yapılacak

OB1 - 120
STRÜKTÜREL BÖLME
VISION PARTITION

İMALAT ÖLÇÜLERİ

vision partition

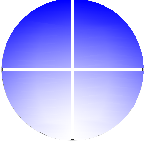

KASET İMALAT ÖLÇÜLERİ

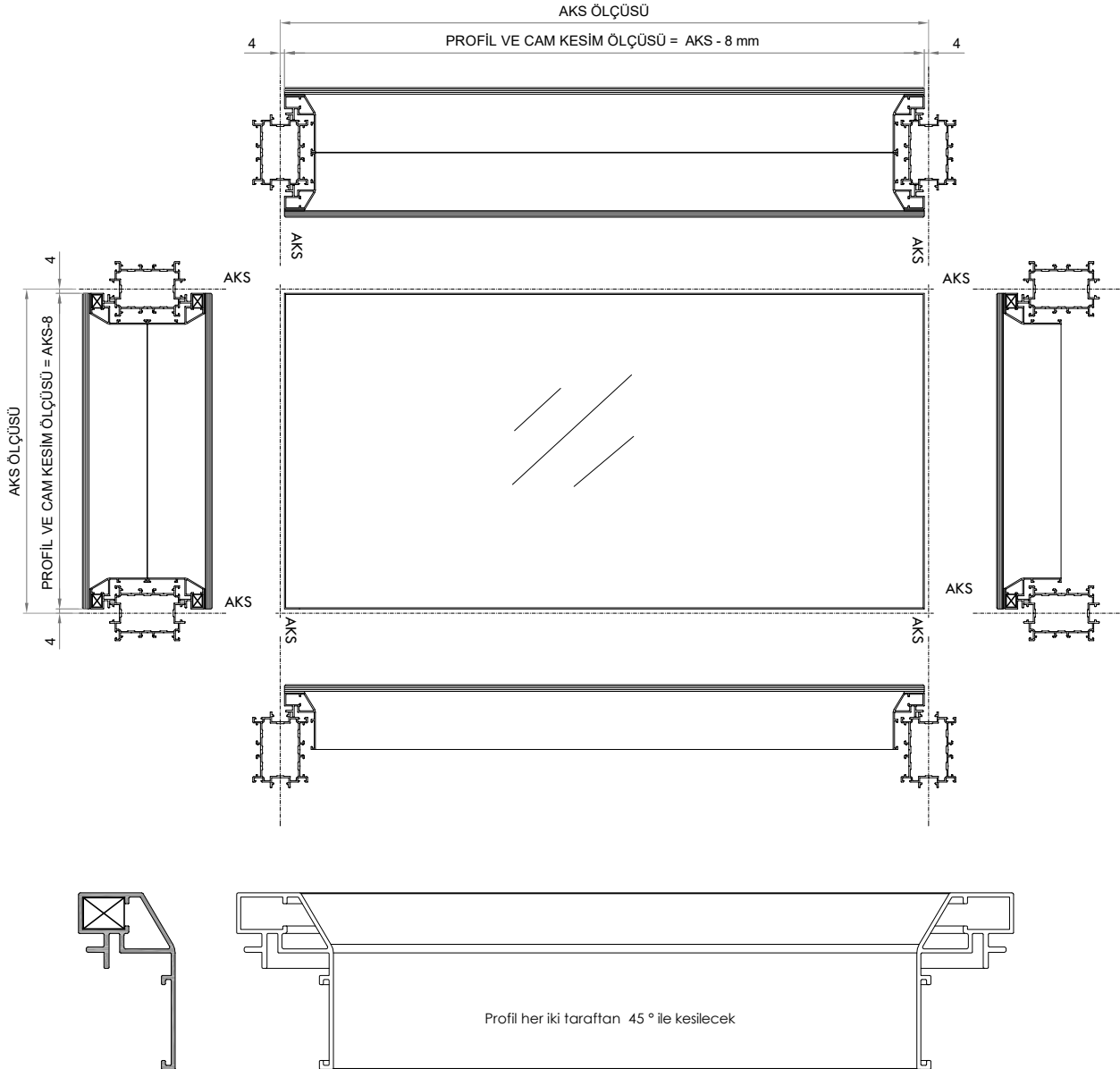
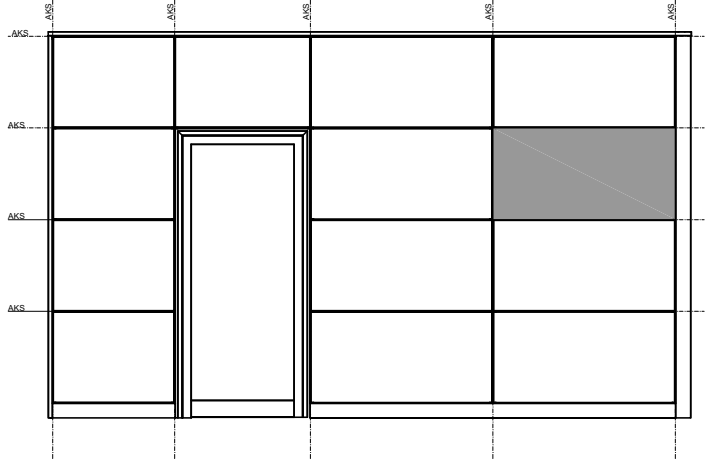
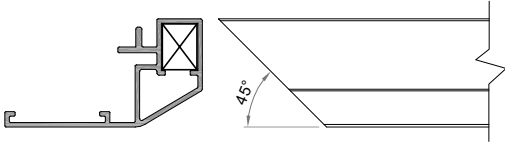

ÖLÇEKSİZDİR

OB1 - 120

STRÜKTÜREL BÖLME

VISION PARTITION

İMALAT ÖLÇÜLERİ

vision partition

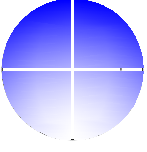

KASET KÖŞE BİRLEŞTİRME ÖLÇÜLERİ

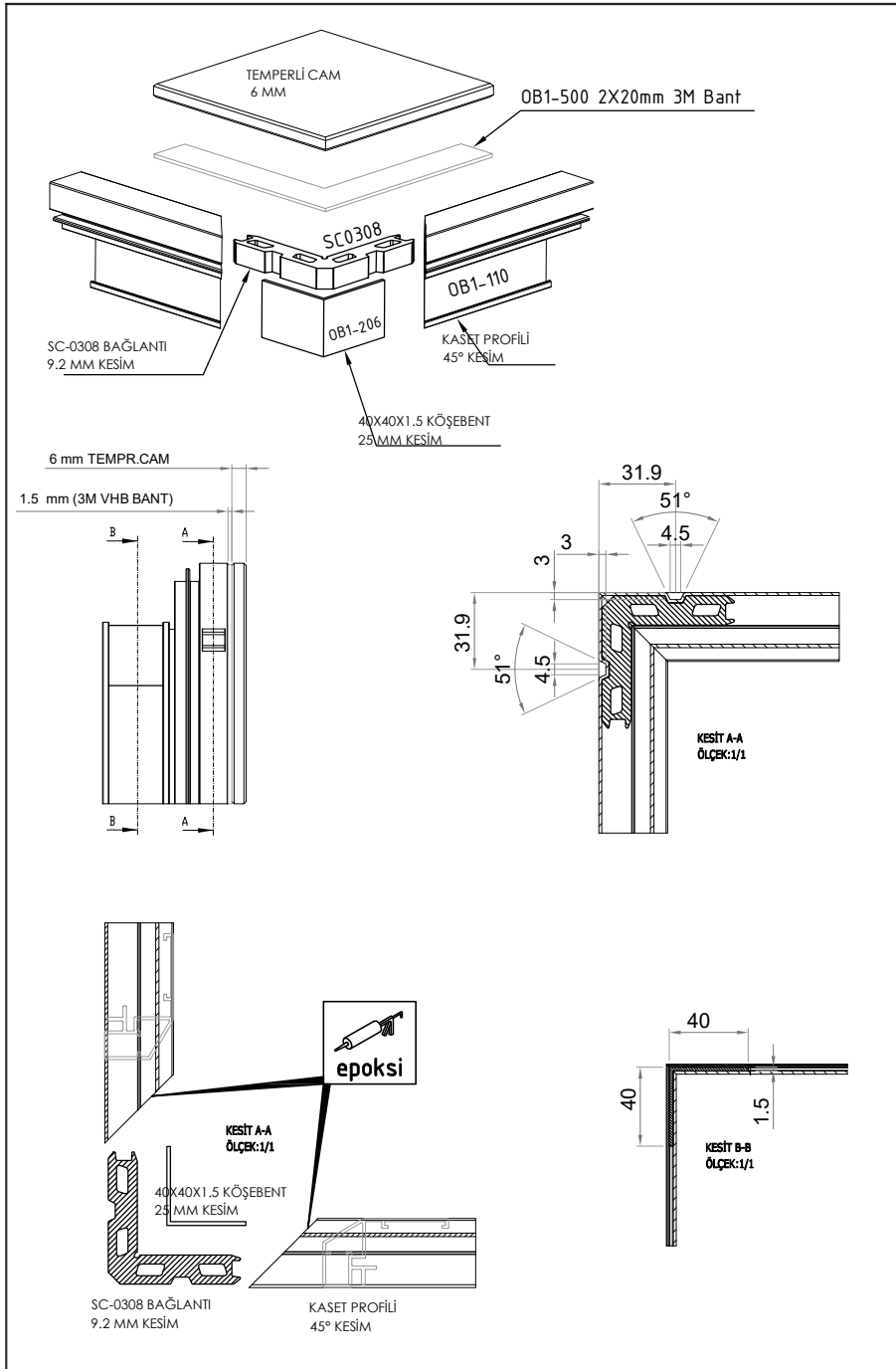
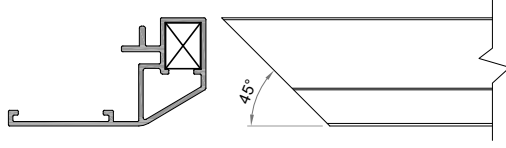

ÖLÇESİZDİR

OB1 - 120
STRÜKTÜREL BÖLME
VISION PARTITION

İMALAT ÖLÇÜLERİ

.....

vision partition

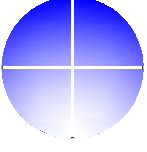

KASET İMALAT ÖLÇÜLERİ

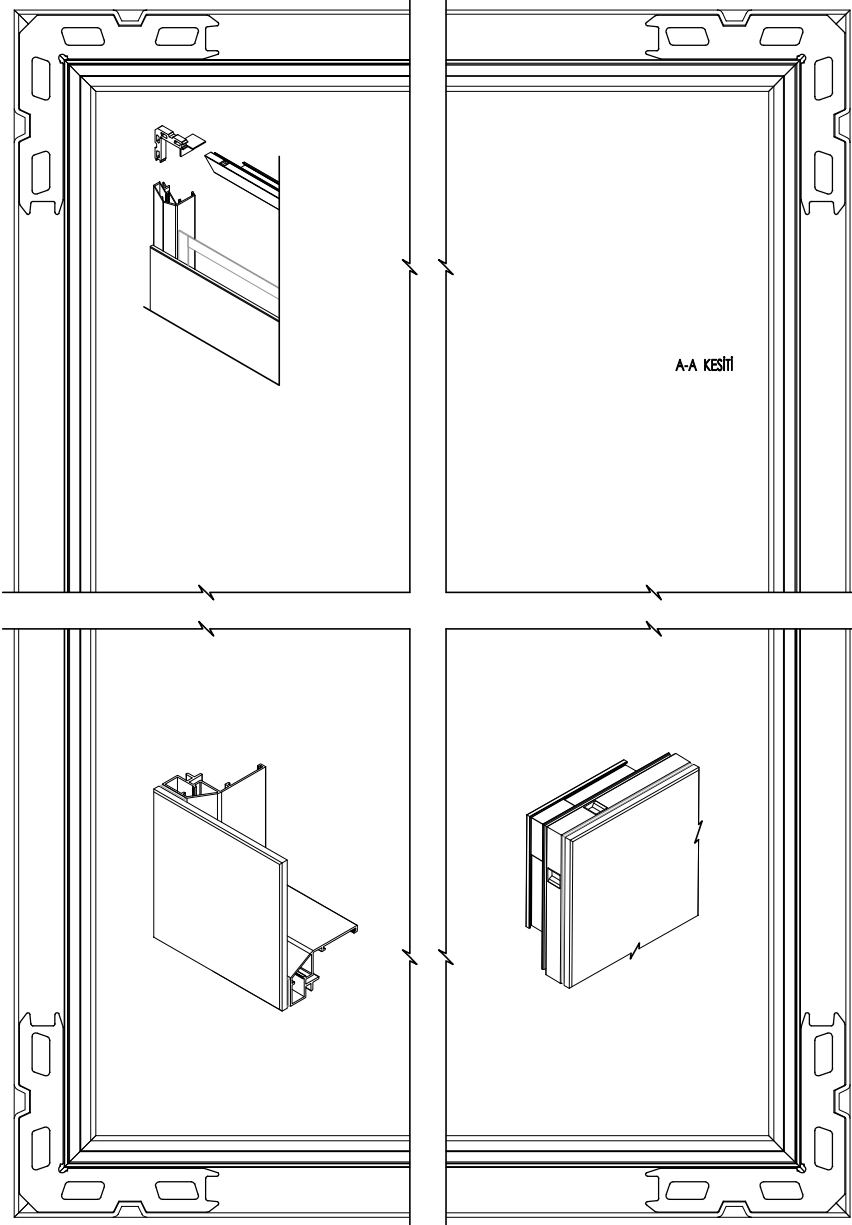
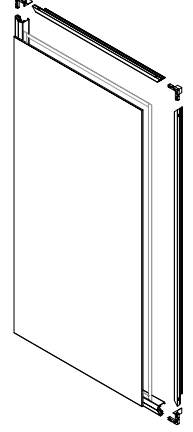
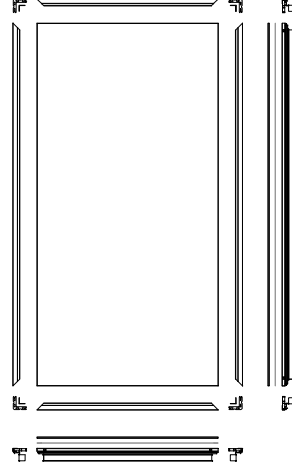
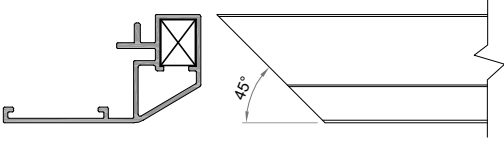

ÖLÇESİZDİR

OB1 - 120
STRÜKTÜREL BÖLME
VISION PARTITION

İMALAT ÖLÇÜLERİ

vision partition

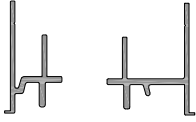
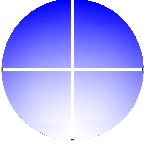

AHŞAP PANEL UYGULAMA

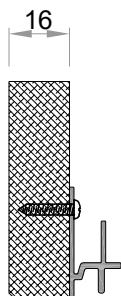
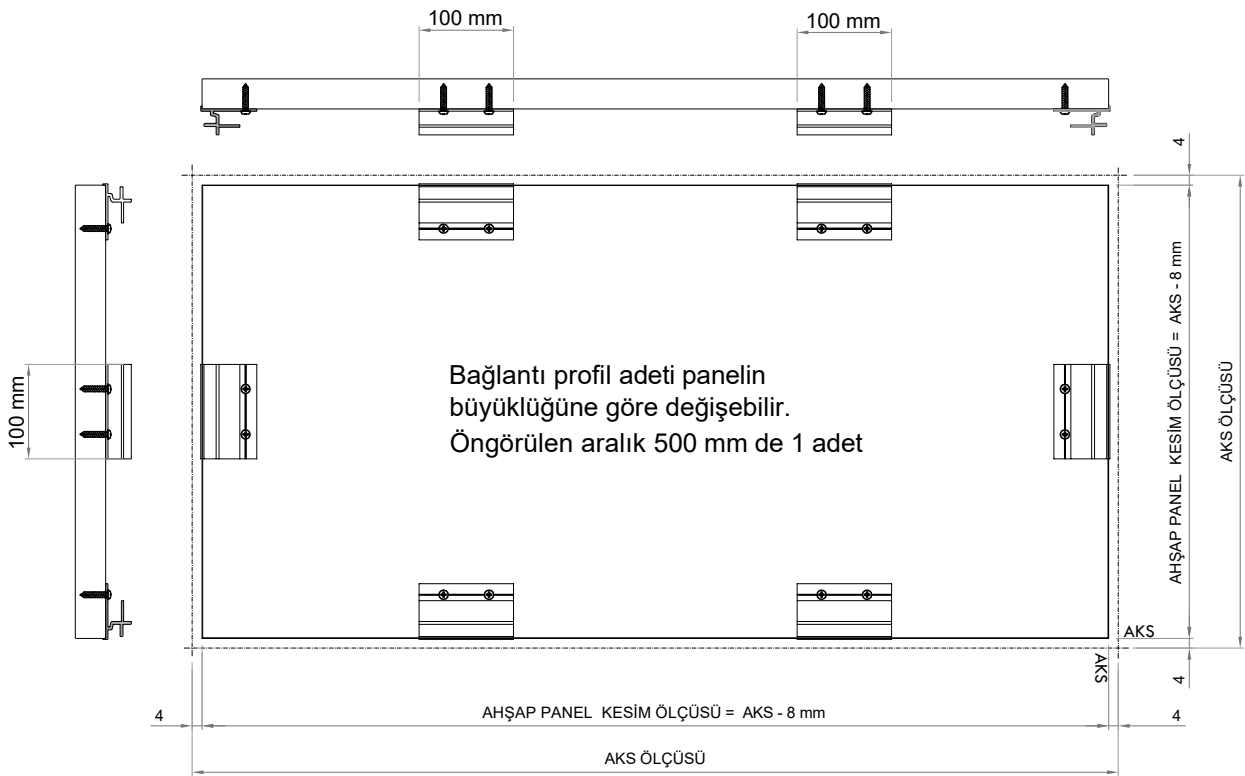
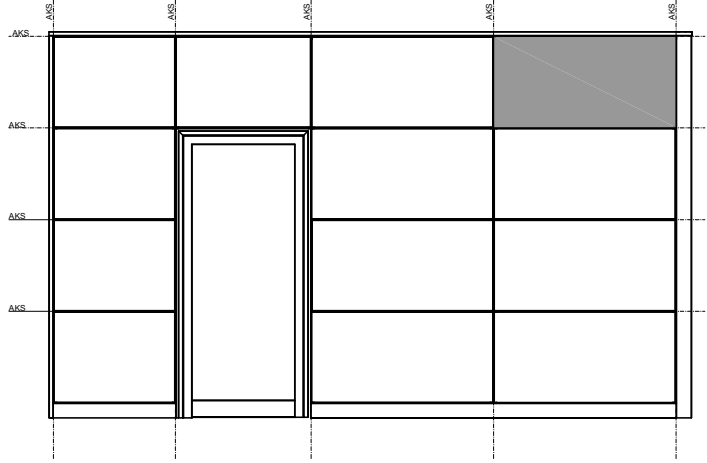

Suntalam veya mdf panelde malzeme kalınlığı mimari projenin tercihine bırakılmıştır.

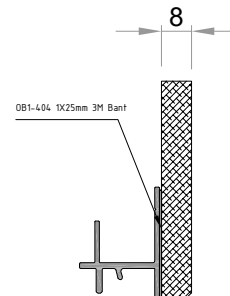

ÖLÇESİZDİR

OB1 - 120
STRÜKTÜREL BÖLME
VISION PARTITION

İMALAT ÖLÇÜLERİ





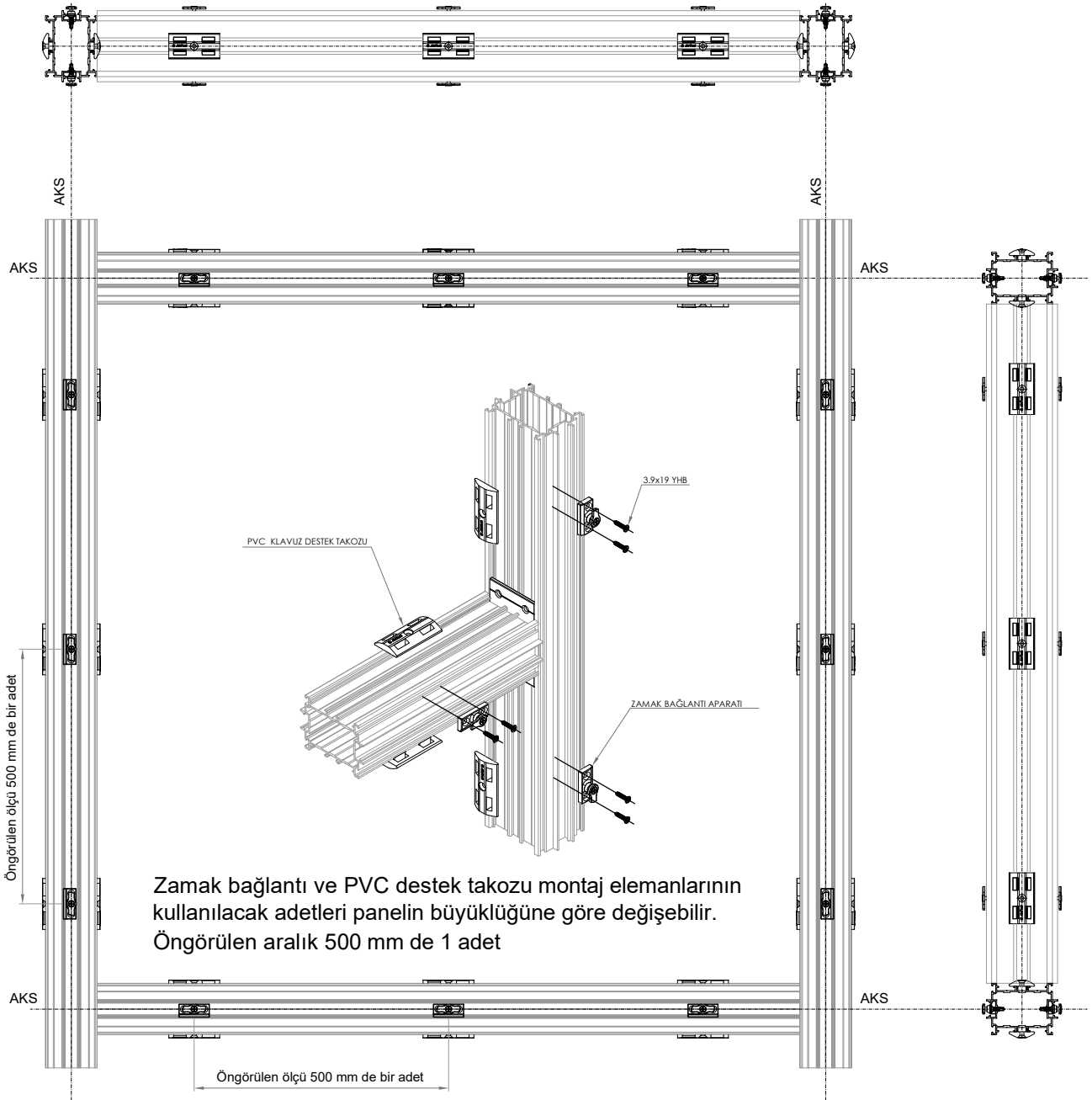
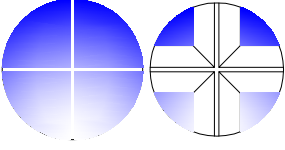

vision partition

frame partition

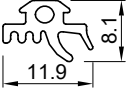
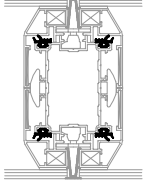
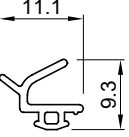
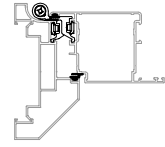
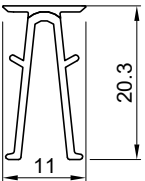
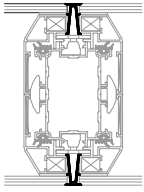
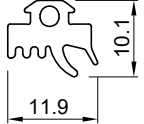
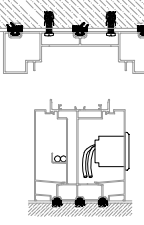

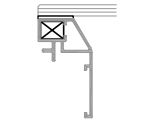
OB1-120
STRUKTUREL OFIS BOLME
VISION PARTITION

Fitil listesi
Gasket list

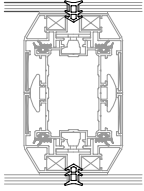
kod code	şekil drawing	tanım description	teorik ağırlık theoretical weight gr / m	paket ağırlığı package weight kg / package	paket metrajı in one package metre / package	kullanım yeri aplication
SC0422		Taşıyıcı ve Panel iç fitili Mullion-transom or Panel gasket inside	46 gr/m	15 kg	326 m	
W1-703		epdm çarpma iç-dış fitil glazing acoustical (epdm)	33 gr/m	15 kg	440 m	
OB1-401		8 mm derz fitil 8 mm joint seals (epdm)	79 gr/m	38 kg	80 Adet 6 Metre	
SC0407		Taşıyıcı ve Panel iç fitili Mullion-transom or Panel gasket inside	73 gr/m	15 kg	205 m	
OB1-403		OB1-403 2X20mm 3M Gri Bant				
OB1-404		OB1-404 1X25mm 3M Şeffaf Bant				
OB1-402		8 mm derz fitil 8 mm joint seals (epdm)	90.2 gr/m	15 kg	165.3 Metre	

OB1-120
STRUKTUREL OFIS BOLME
VISION PARTITION

ZAMAK BAĞLANTI MEKANİZMALARI
Zinc CONNECTION MECHANISMS

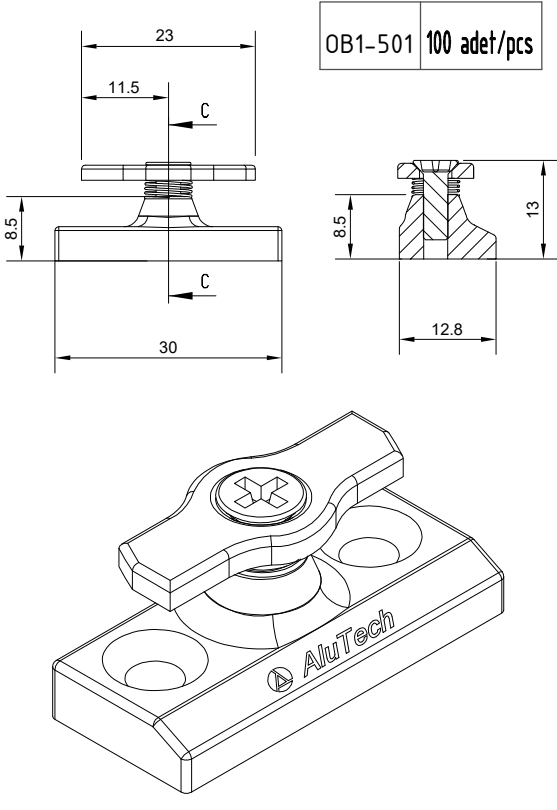
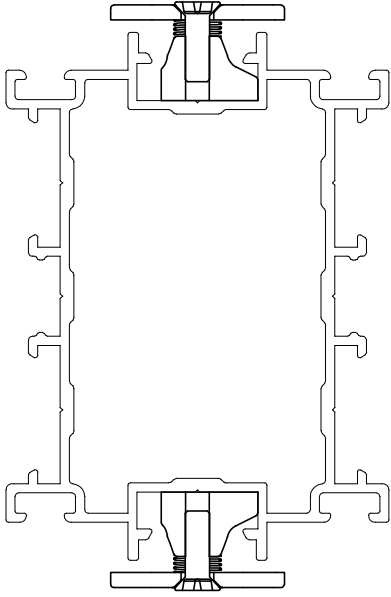
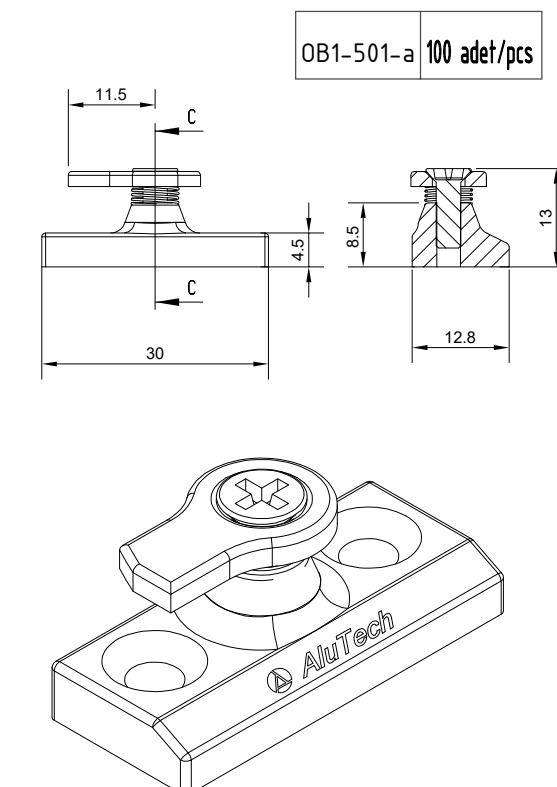
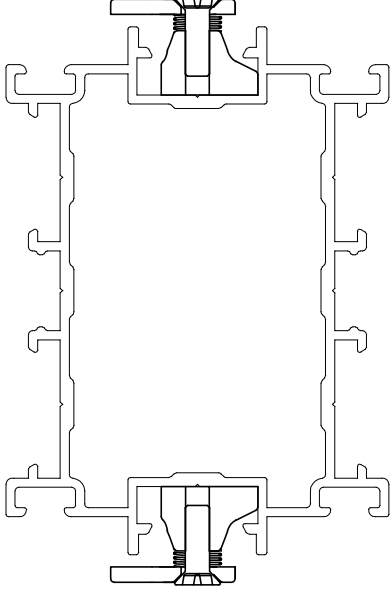
kod code	şekil drawing	tanım description	kullanım yeri application
OB1-501	 <p>OB1-501 100 adet/pcs</p>	Panel sabitleme mekanizması Panel stabilization mechanism	
OB1-501-a	 <p>OB1-501-a 100 adet/pcs</p>	Panel sabitleme mekanizması Panel stabilization mechanism	

OB1-120
STRUKTUREL OFIS BOLME
VISION PARTITION

KILAVUZ & DESTEK TAKOZU
GUIDANCE & SUPPORT SUPPORT

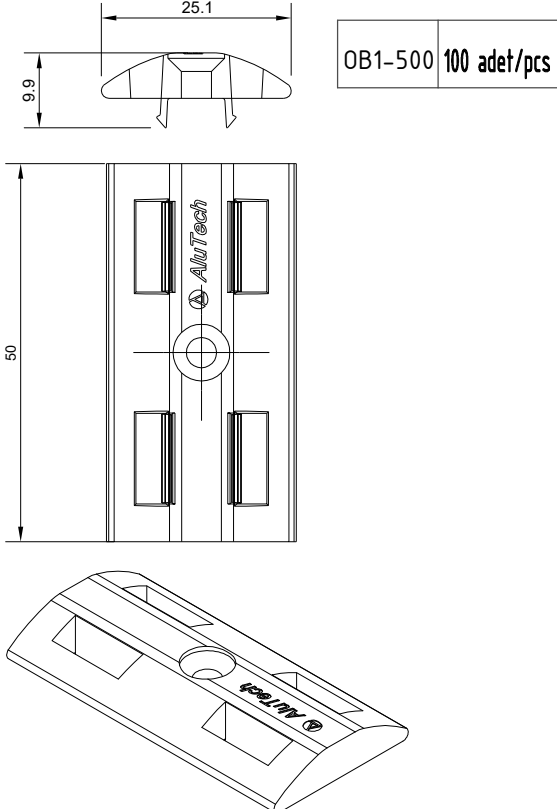
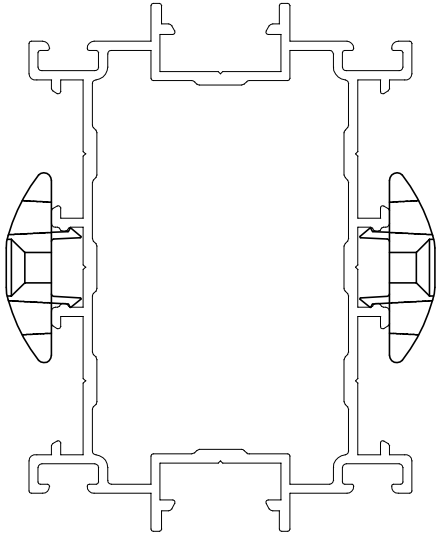
kod code	şekil drawing	tanım description	kullanım yeri application		
OB1-500	 <table border="1" data-bbox="608 456 831 524"><tr><td>OB1-500</td><td>100 adet/pcs</td></tr></table>	OB1-500	100 adet/pcs	Panel klavuz ve destek takozu Panel guide and support mount	
OB1-500	100 adet/pcs				